



**HESTORE.HU**

elektronikai alkatrész áruház

**EN:** This Datasheet is presented by the manufacturer.

Please visit our website for pricing and availability at [www.hestore.hu](http://www.hestore.hu).

# DTMSS-47 SENDUST POWER INDUCTORS



## APPLICATIONS:

- interference suppressing chokes (DC - 300kHz)
- energy storage inductors (DC - 300kHz)
- DC/DC converters
- SMPS
- EMI filters (DC - 1 MHz)
- acoustic filters

## ORDERING CODE:

DTMSS- 47 / 6,8 / 0,4 -V

mounting: V - vertical, H - horizontal, BV - base vertical,  
 CH - case horizontal, CV - case vertical  
 rated current in Amps  
 inductance in mH@ $I_{DC} = 0A$   
 sendust core outer diameter  
 product symbol

## DIMENSIONS:

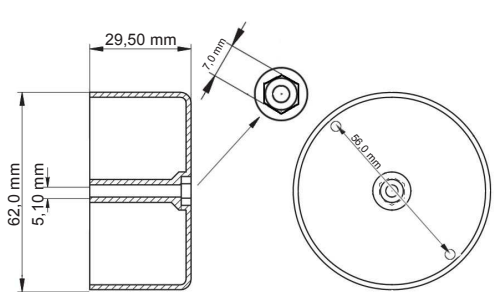
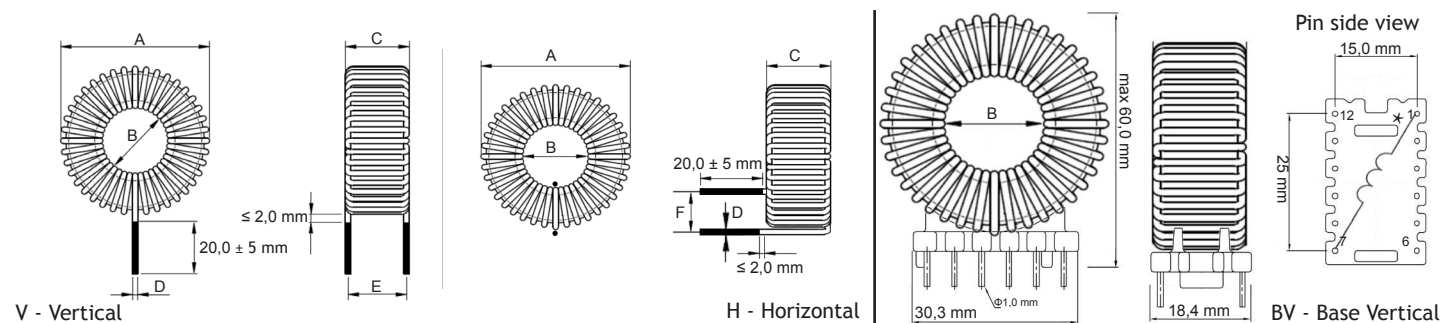

CH - Case Horizontal

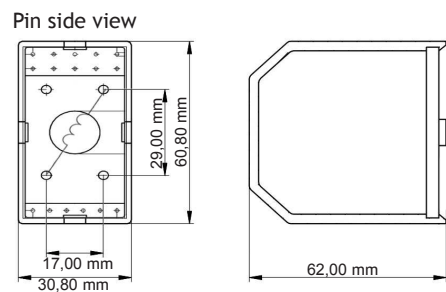

CV - Case Vertical

Part number	Type - core dimension ( $\pm 10\%$ )						Mounting version				
	A [mm]	B [mm]	C [mm]	D [mm]	E [mm]	F [mm]	V	H	BV	CV	CH
DTMSS-47/6,8/0,4	48,5	21,5	20,0	0,23	21,0	13,0	✓	✓	✓	✓	✓
DTMSS-47/4,7/0,7	48,5	21,5	20,0	0,30	21,0	13,0	✓	✓	✓	✓	✓
DTMSS-47/3,3/0,8	49,0	21,5	20,0	0,32	21,0	13,5	✓	✓	✓	✓	✓
DTMSS-47/2,2/1,2	49,0	21,0	20,5	0,40	21,0	13,5	✓	✓	✓	✓	✓
DTMSS-47/1,5/2,0	49,5	20,5	20,5	0,50	21,0	13,5	✓	✓	✓	✓	✓
DTMSS-47/1,0/4,0	52,0	18,0	23,0	1,00	22,0	15,0	✓	✓	✓	✓	✓
DTMSS-47/0,68/6,0	52,0	18,0	23,0	1,15	22,0	17,0	✓	✓	✓	✓	✓
DTMSS-47/0,47/8,0	52,0	16,5	23,0	1,40	23,5	17,0	✓	✓	–	✓	✓
DTMSS-47/0,33/10	53,0	16,0	23,5	1,70	23,5	17,0	✓	✓	–	✓	✓
DTMSS-47/0,22/15	53,0	15,5	24,0	1,90	23,5	18,5	✓	✓	–	✓	✓
DTMSS-47/0,15/18	53,0	17,0	24,0	2,70	24,5	18,5	✓	✓	–	✓	✓
DTMSS-47/0,10/30	55,0	14,0	25,0	2,90	24,5	19,0	✓	✓	–	✓	✓
DTMSS-47/0,068/45	56,0	12,0	26,5	4,00	24,5	19,0	✓	✓	–	✓	✓

**ELECTRICAL PROPERTIES:**

Part number	Lmax [μH]	I <sub>max</sub> [A]	L@I <sub>max</sub> [μH]	RDC [Ω]	Δt [°C]
DTMSS-47/6,8/0,4	6800	0,40	6690	6,03	9,60
DTMSS-47/4,7/0,7	4700	0,70	4520	3,12	13,9
DTMSS-47/3,3/0,8	3300	0,80	3190	2,22	12,5
DTMSS-47/2,2/1,2	2200	1,20	2080	1,13	14,0
DTMSS-47/1,5/2,0	1500	2,00	1360	0,567	18,8
DTMSS-47/1,0/4,0	1000	4,00	802	0,290	34,3
DTMSS-47/0,68/6,0	680	6,00	492	0,205	46,6
DTMSS-47/0,47/8,0	470	8,00	328	0,104	44,0
DTMSS-47/0,33/10	330	10,0	221	0,0540	36,7
DTMSS-47/0,22/15	220	15,0	129	0,0375	27,3
DTMSS-47/0,15/18	150	18,0	89,4	0,0189	39,0
DTMSS-47/0,10/30	100	30,0	44,5	0,00966	50,6
DTMSS-47/0,068/45	68	45,0	24,4	0,00495	46,1

**CHARACTERISTICS:**

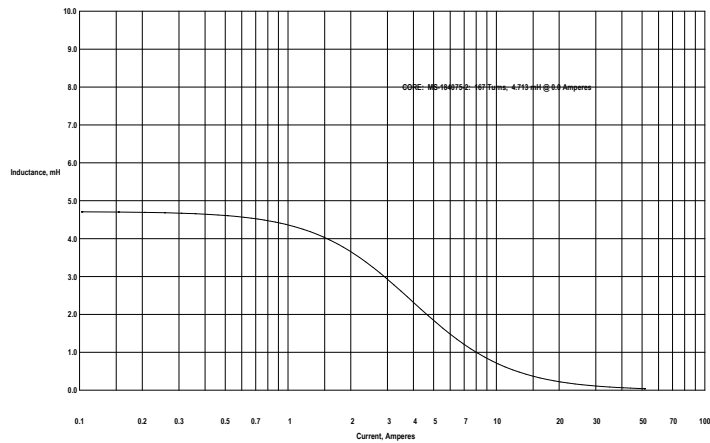

CREATED IN MICROMETALS ARNOLD POWDER CORES - DESIGN OF INDUCTORS FOR POWER FILTER APPLICATIONS Mon Nov 28 10:08:24 2011

DTMSS-47/6,8/0,4

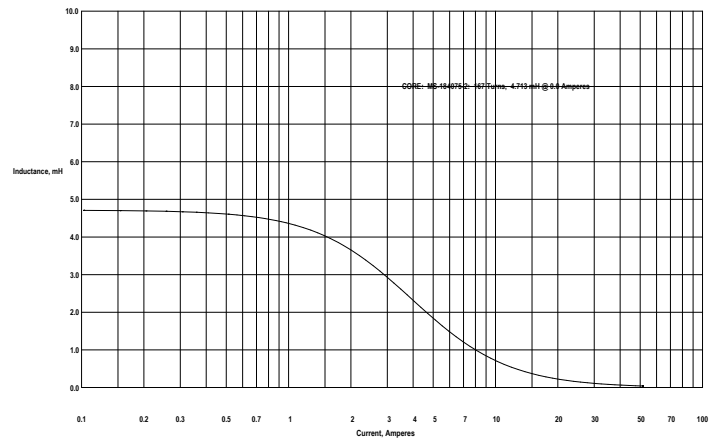

CREATED IN MICROMETALS ARNOLD POWDER CORES - DESIGN OF INDUCTORS FOR POWER FILTER APPLICATIONS Mon Nov 28 10:08:24 2011

DTMSS-47/4,7/0,7

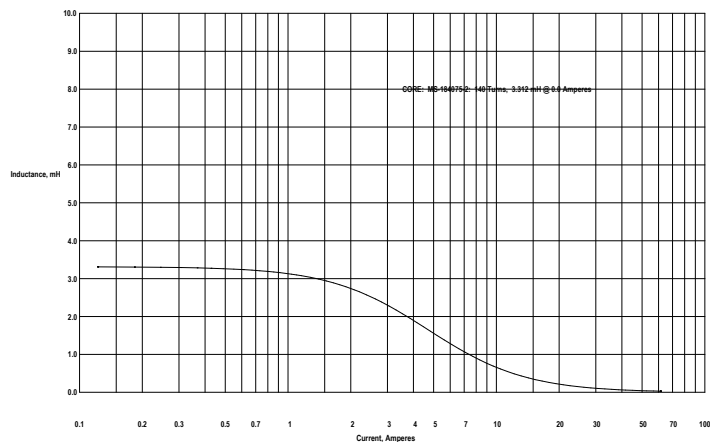

CREATED IN MICROMETALS ARNOLD POWDER CORES - DESIGN OF INDUCTORS FOR POWER FILTER APPLICATIONS Mon Nov 28 10:06:47 2011

DTMSS-47/3,3/0,8

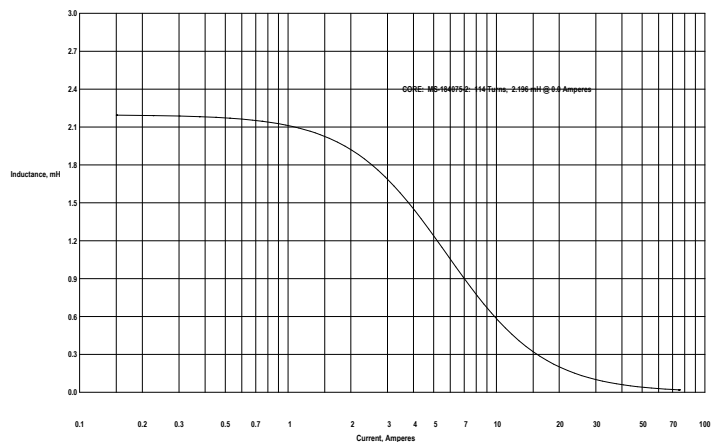

CREATED IN MICROMETALS ARNOLD POWDER CORES - DESIGN OF INDUCTORS FOR POWER FILTER APPLICATIONS Mon Nov 28 10:10:33 2011

DTMSS-47/2,2/1,2

**CHARACTERISTICS:**

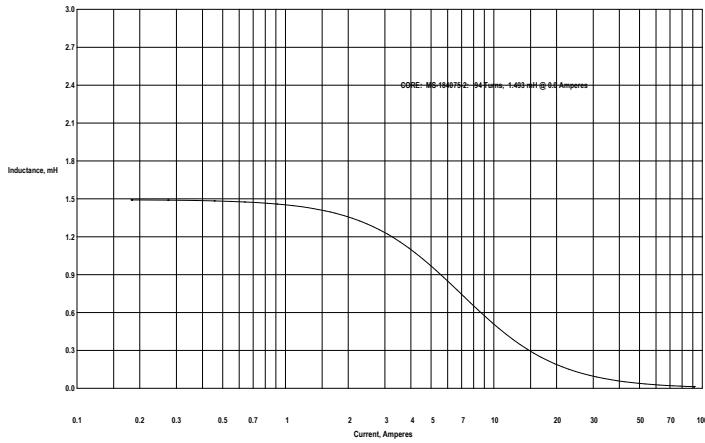

CREATED IN MICROMETALS ARNOLD POWDER CORES - DESIGN OF INDUCTORS FOR POWER FILTER APPLICATIONS Mon Nov 28 10:11:44 2011

DTMS-47/1,5/2,0

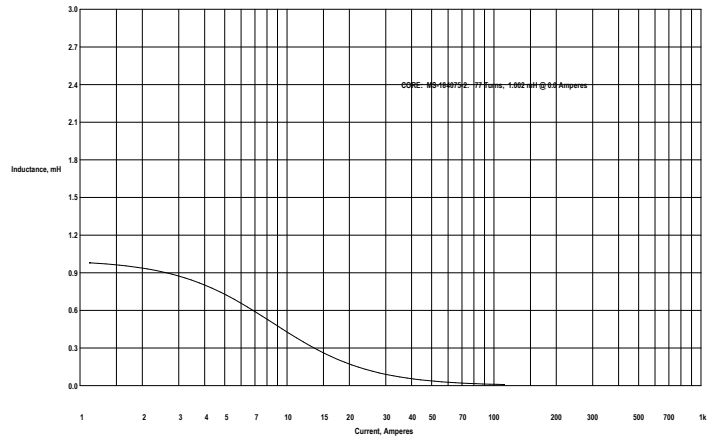

CREATED IN MICROMETALS ARNOLD POWDER CORES - DESIGN OF INDUCTORS FOR POWER FILTER APPLICATIONS Mon Nov 28 10:13:07 2011

DTMS-47/1/4,0

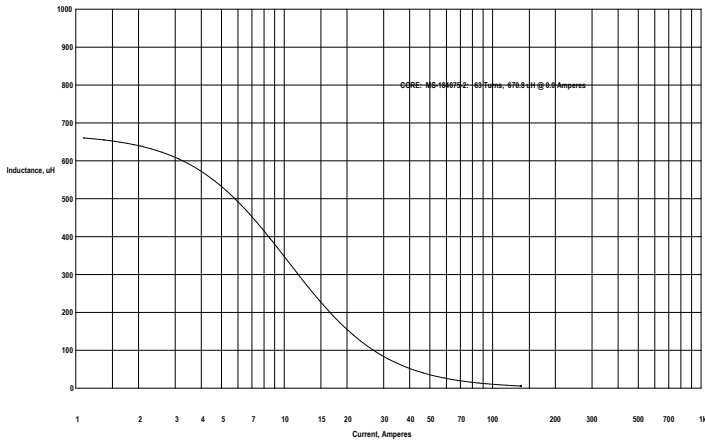

CREATED IN MICROMETALS ARNOLD POWDER CORES - DESIGN OF INDUCTORS FOR POWER FILTER APPLICATIONS Mon Nov 28 10:14:36 2011

DTMS-47/0,68/6,0

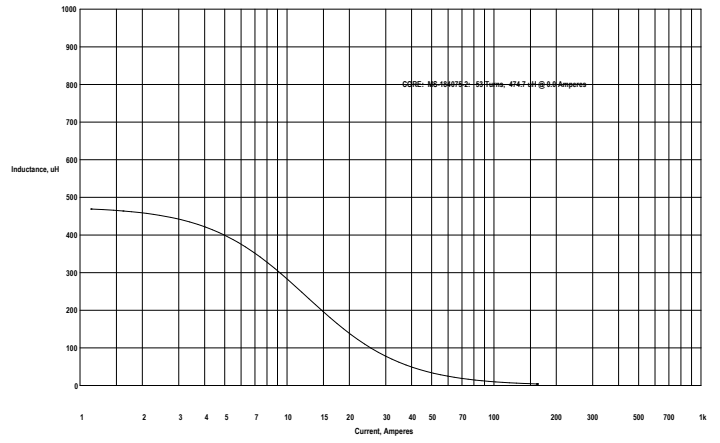

CREATED IN MICROMETALS ARNOLD POWDER CORES - DESIGN OF INDUCTORS FOR POWER FILTER APPLICATIONS Mon Nov 28 10:16:02 2011

DTMS-47/0,47/8,0

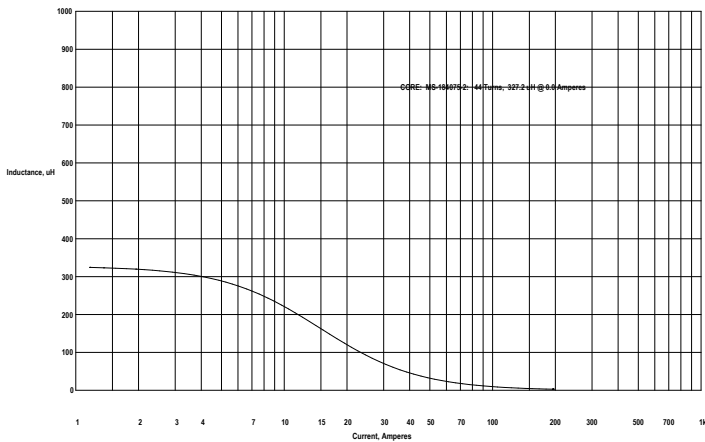

CREATED IN MICROMETALS ARNOLD POWDER CORES - DESIGN OF INDUCTORS FOR POWER FILTER APPLICATIONS Mon Nov 28 10:17:10 2011

DTMS-47/0,33/10

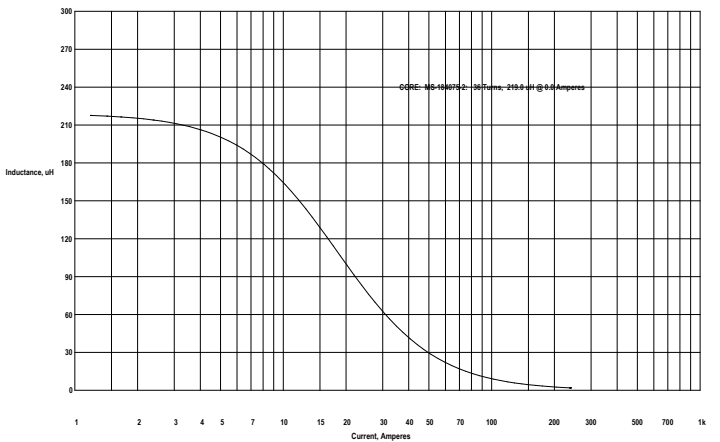

CREATED IN MICROMETALS ARNOLD POWDER CORES - DESIGN OF INDUCTORS FOR POWER FILTER APPLICATIONS Mon Nov 28 10:19:42 2011

DTMS-47/0,22/15

**CHARACTERISTICS:**

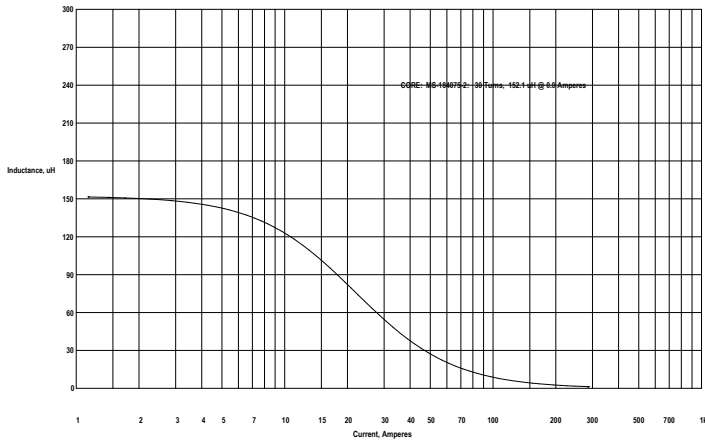

CREATED IN MICROMETALS ARNOLD POWDER CORES - DESIGN OF INDUCTORS FOR POWER FILTER APPLICATIONS Mon Nov 28 10:23:30 2011

DTSS-47/0,15/18

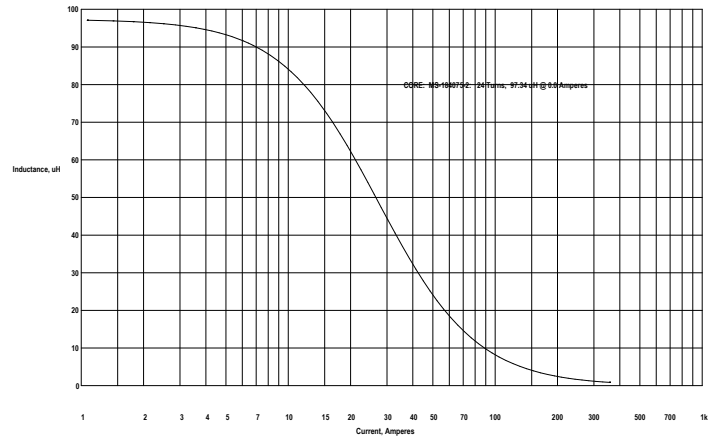

CREATED IN MICROMETALS ARNOLD POWDER CORES - DESIGN OF INDUCTORS FOR POWER FILTER APPLICATIONS Mon Nov 28 13:23:07 2011

DTSS-47/0,1/30

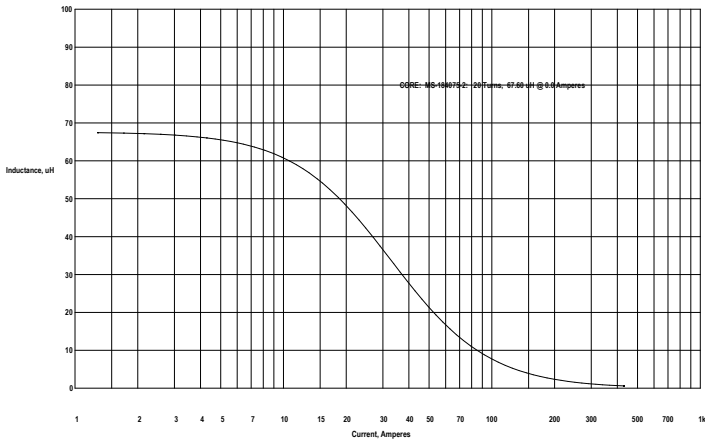

CREATED IN MICROMETALS ARNOLD POWDER CORES - DESIGN OF INDUCTORS FOR POWER FILTER APPLICATIONS Mon Nov 28 13:24:29 2011

DTSS-47/0,068/45