



HESTORE.HU

elektronikai alkatrész áruház

EN: This Datasheet is presented by the manufacturer.

Please visit our website for pricing and availability at www.hestore.hu.

6,5 cm Breitbandlautsprecher / 2.5" Fullrange Speakers

FRS 7 W Art. No. 2017 – 8 Ω

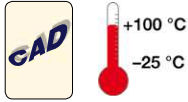

Art. No. 2312

6,5 cm (2.5") Breitbandlautsprecher mit ausgeglichenem Frequenzgang und sehr gutem Hochtonanteil. Besonders geeignet als Einbaulautsprecher für die Musikwiedergabe sowie zur Bestückung von ELA Zeilen. Tiefe Resonanzfrequenz und sehr großer Hub.

Anwendungsmöglichkeiten: Schmale ELA-Zeilen, Kontroll-Lautsprecher für elektronische Geräte, Modellbau, Elektronische Musikinstrumente

Zubehör: Schutzgitter (Art. No. 2312)

6.5 cm (2.5") full range speaker with balanced frequency response and very good highs. Especially suitable as built-in speaker for music reproduction and as driver for 100 V network column speakers. Very low resonance frequency and maximum cone displacement.

Typical applications: Narrow network column speakers, Control speaker for electronic devices, Model construction, Electronic musical instruments

Accessories: Protective grille (Art. No. 2312)

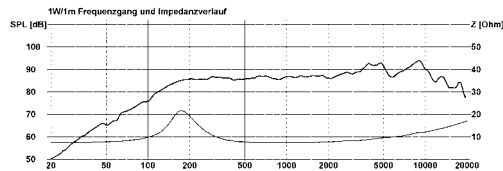
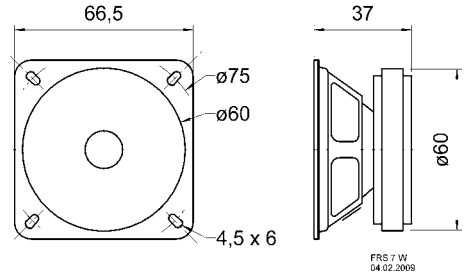
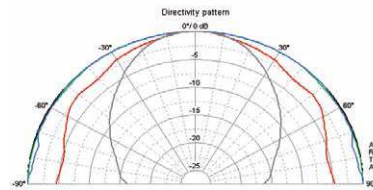

FR 7 Art. No. 2015 – 4 Ω

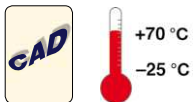

Art. No. 2312

6,5 cm (2.5") Breitbandlautsprecher mit geringer Einbautiefe und kleinem Magnet, daher besonders auch für den Einbau in beengten Platzverhältnissen geeignet. Gleichmäßiger Frequenzgang und guter Schalldruckpegel sowie sehr guter Hochtonanteil.

Anwendungsmöglichkeiten: Schmale ELA-Zeilen, Kontroll-Lautsprecher für elektronische Geräte, Modellbau, Elektronische Musikinstrumente. **Zubehör:** Schutzgitter (Art.-No. 2312)

6.5 cm (2.5") full range speaker minimal mounting depth and small magnet. Balanced frequency response and high efficiency. Very good high range response. Suitable in machines and other equipment where space is at a premium.

Typical applications: Narrow network column speakers, Control speaker for electronic devices, Model construction, Electronic musical instruments. **Accessories:** Grille (Art.-No. 2312).

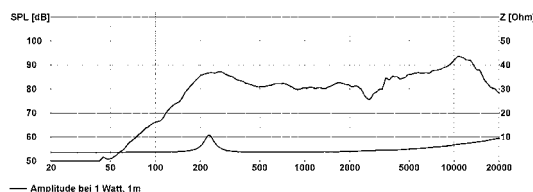
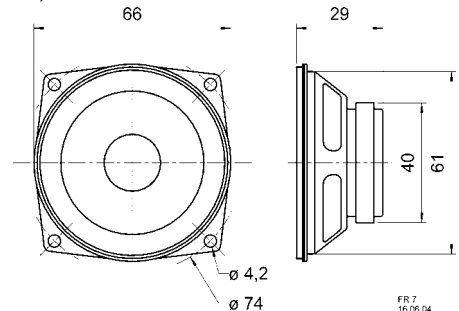
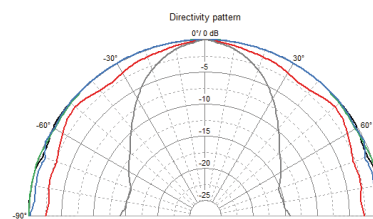

		FRS 7 W	FR 7
Nenn-/Musikbelastbarkeit	Rated/maximum power	8 W / 15 W	5 W / 10 W
Impedanz	Impedance	8 Ω	4 Ω
Übertragungsbereich (-10 dB)	Frequency response (-10 dB)	120-20000 Hz	130-20000 Hz
Mittlerer Schalldruckpegel	Mean sound pressure level	86 dB (1 W/1 m)	86 dB (1 W/1 m)
Grenzauslenkung x _{mechan}	Excursion limit x _{mechan}	± 2,5 mm	± 1 mm
Resonanzfrequenz	Resonance frequency	160 Hz	220 Hz
Obere Polplattenhöhe	Height of front pole-plate	2,5 mm	2,5 mm
Schwingspulendurchmesser	Voice coil diameter	14 mm Ø	14 mm Ø
Wickelhöhe	Height of winding	4,5 mm	2,5 mm
Schallwandöffnung	Cutout diameter	61 mm Ø	61 mm Ø
Gewicht netto	Net weight	0,22 kg	0,092 kg

Weitere Daten Seiten 156-157 / for further data see pages 156-157