



HESTORE.HU

elektronikai alkatrész áruház

EN: This Datasheet is presented by the manufacturer.

Please visit our website for pricing and availability at www.hestore.hu.

Mini USB CONNECTOR

ESB 3 SERIES (CONNECTOR)



FEATURES

- Ultra-small size achieved universal series bus connector.
- Both 4Pin type and 5Pin (One ID pin) type are 0.8mm pitch.
- 5Pin type connector and cables are USB 2.0 approval.
- Receptacle and plug housing are UL 94V-0 grade fire retardant.
- Gold plated contact ensure low contact resistance.
- To make sure your connections are perfect every time.
- EMI protection by shielding features.

APPLICATIONS

- Ideal for connecting portable PCs as slim notebook PCs and handheld PCs to small, slim peripheral equipment (digital cameras, small mouse, PDA, MP3, Hub etc.).

SPECIFICATIONS

ELECTRICAL		MECHANICAL	
Voltage rating	30 VAC(rms)	Durability	1500 cycles (for 4 pin)
Current rating	1 Amp		5000 cycles (for 5 pin)
Contact resistance	50 m Ω Max.	Mating force	35N Max.
Insulation resistance	100 M Ω Min.	Unmating force	2.9N Min.
Dielectric strength	100 VAC Min.	---	---

PART NUMBERING SYSTEM

<u>ESB</u>	<u>3</u>	<u>X</u>	<u>X</u>	<u>X</u>	<u>X</u>	<u>X</u>	<u>X</u>	<u>X</u>	<u>X</u>
------------	----------	----------	----------	----------	----------	----------	----------	----------	----------

----- Z:RoHS Compliant
----- Special Code:
0:Embossed type
1:Tube packed
2:Mylar/Embossed type
3:Mylar/Tube packed
----- Mark:
0:Standard
1:No ECE Mark
----- Terminal Type:
0:SMT type
2:Solder wire type
3:Through Hole type
----- Terminal Pole:
0:4Pin (USB 1.1)
1:5Pin (USB 2.0)
----- Color: 0:Black
----- Port Type: 1:Single Port
----- Setting:
Socket:
3:A Type(for 4pin only)
4:B Type(for 4pin & 5pin both)
5:C Type(for 5pin only)
6:B Type(for 5pin, right angle, Shell T/H)
7:B Type(for 5pin, Straight, Shell T/H)
Plug:
A:for B type 5pin
----- Contact Type: 3:Mini USB Connector
----- Model Name: ESB Series

DIMENSIONS (UNIT:mm)

ESB 3A101211Z



ESB 37



**A TYPE CONNECTOR
(4PIN)**



**B TYPE CONNECTOR
(4PIN)**



**B TYPE CONNECTOR
(5PIN)**



**B TYPE CONNECTOR
(5PIN, T/H)**



**C TYPE CONNECTOR
(5PIN)**



ESB3A101211Z UNIT:mm

Connection Style: Ultra Small size USB Straight Type.

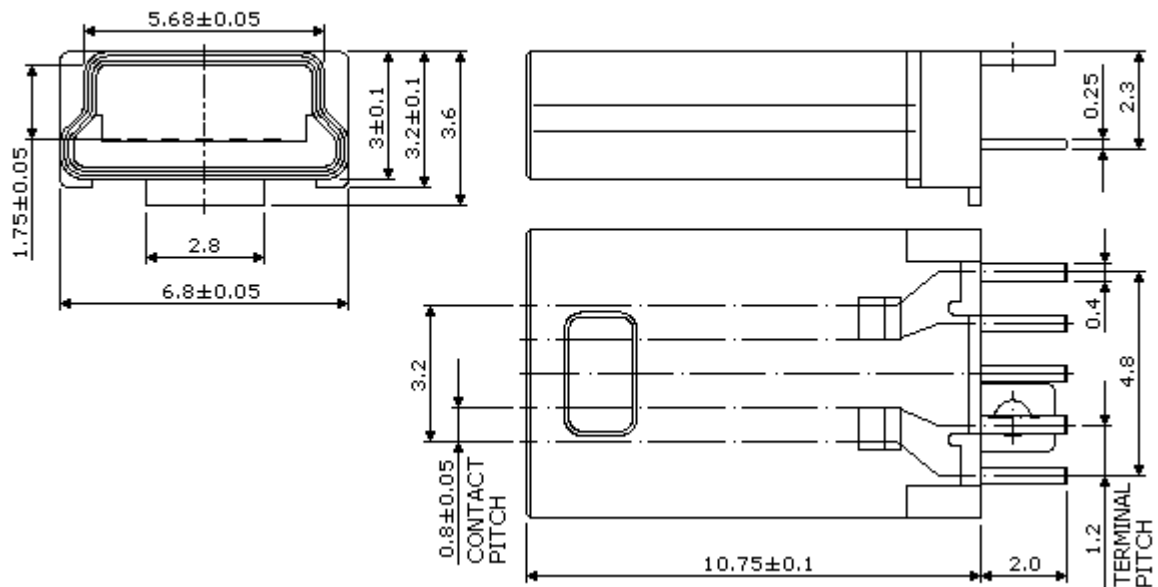

ESB37 UNIT:mm

Connection Style: Mini B Straight type.

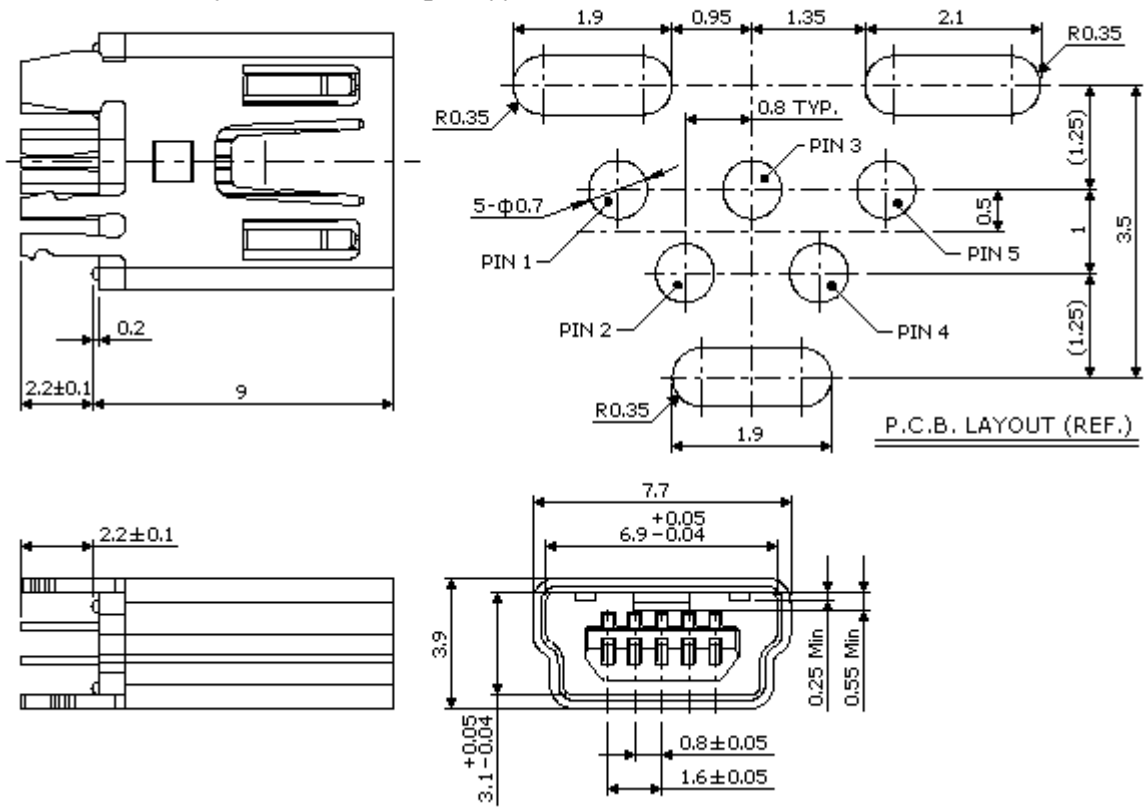

A TYPE CONNECTOR (4 pin) UNIT:mm

P.C.B. LAYOUT

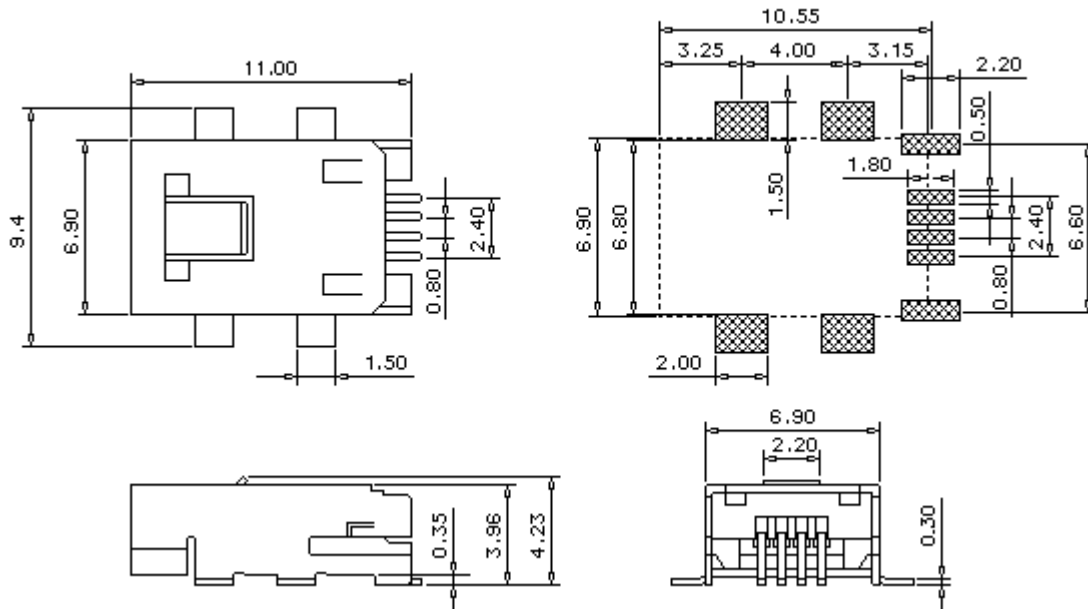

B TYPE CONNECTOR (4 pin) UNIT:mm

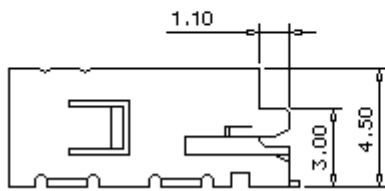
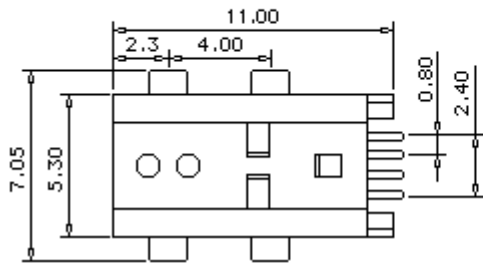

P.C.B. LAYOUT

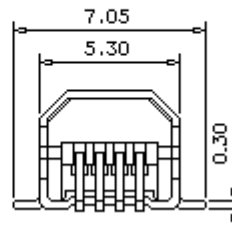
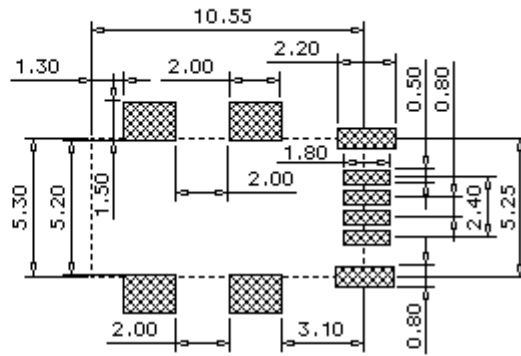

B TYPE CONNECTOR (5 pin) UNIT:mm

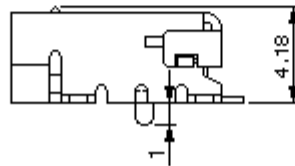
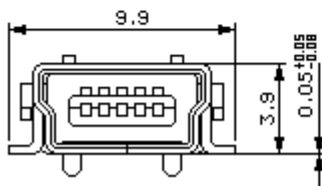
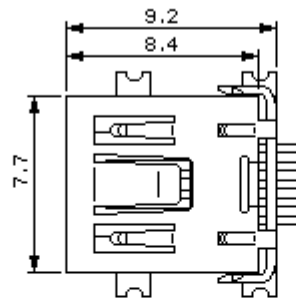

P.C.B. LAYOUT

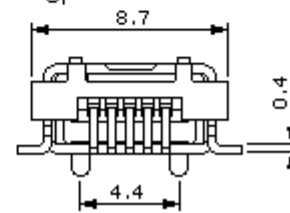
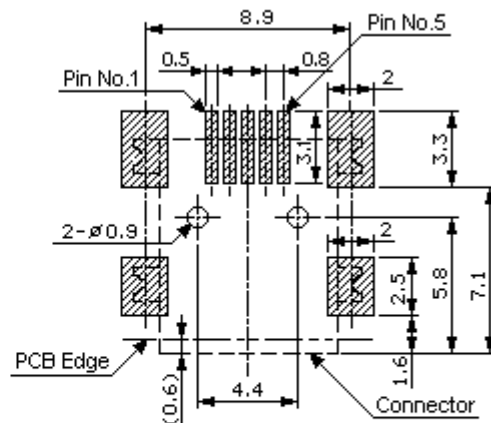

B TYPE CONNECTOR (5 pin, T/H) UNIT: mm

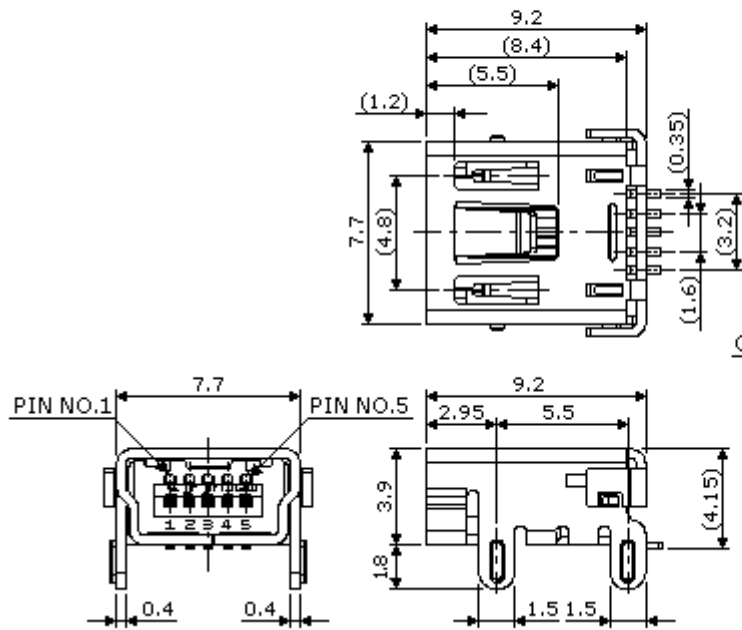

P.C.B. LAYOUT

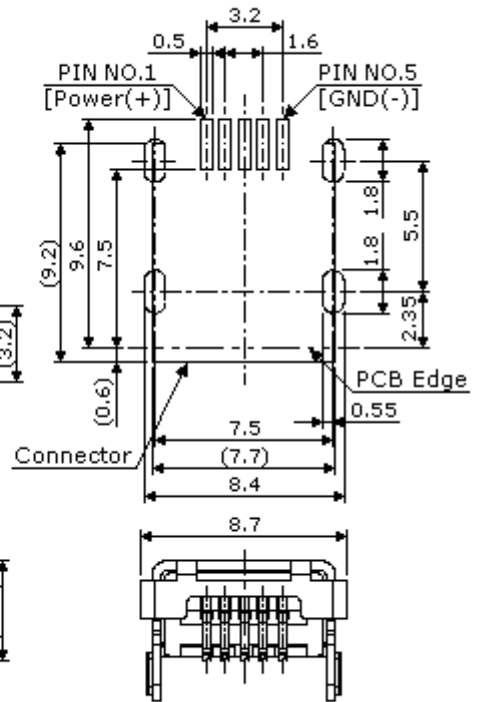

C TYPE CONNECTOR (5 pin) UNIT: mm

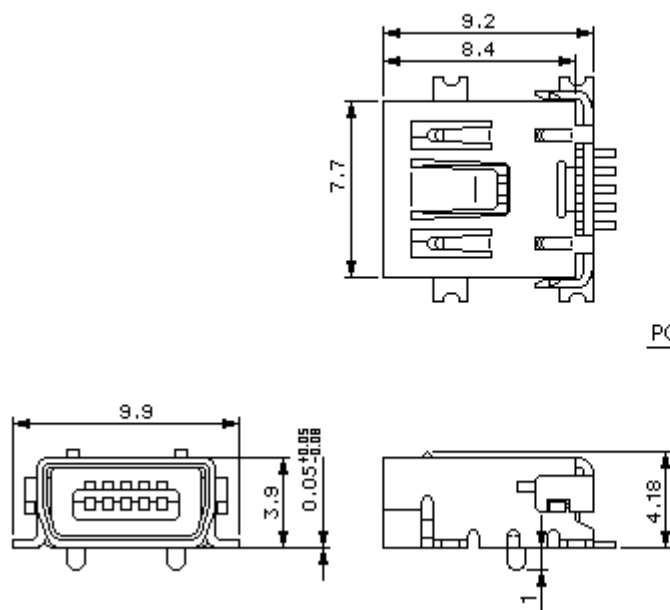

P.C.B. LAYOUT

