



HESTORE.HU

elektronikai alkatrész áruház

EN: This Datasheet is presented by the manufacturer.

Please visit our website for pricing and availability at www.hestore.hu.

NPN - MJ15022, MJ15024*

*MJ15024 is a Preferred Device

Silicon Power Transistors

The MJ15022 and MJ15024 are PowerBase power transistors designed for high power audio, disk head positioners and other linear applications.

Features

- High Safe Operating Area (100% Tested) – 2 A @ 80 V
- High DC Current Gain – $h_{FE} = 15$ (Min) @ $I_C = 8$ Adc
- Pb-Free Packages are Available*

MAXIMUM RATINGS

Rating	Symbol	Value	Unit
Collector-Emitter Voltage MJ15022 MJ15024	V_{CEO}	200 250	Vdc
Collector-Base Voltage MJ15022 MJ15024	V_{CBO}	350 400	Vdc
Emitter-Base Voltage	V_{EBO}	5	Vdc
Collector-Emitter Voltage	V_{CEX}	400	Vdc
Collector Current – Continuous – Peak (Note 1)	I_C	16 30	Adc
Base Current – Continuous	I_B	5	Adc
Total Device Dissipation @ $T_C = 25^\circ\text{C}$ Derate above 25°C	P_D	250 1.43	W W/ $^\circ\text{C}$
Operating and Storage Junction Temperature Range	T_J, T_{stg}	-65 to +200	$^\circ\text{C}$

THERMAL CHARACTERISTICS

Characteristics	Symbol	Max	Unit
Thermal Resistance, Junction-to-Case	$R_{\theta JC}$	0.70	$^\circ\text{C}/\text{W}$

Maximum ratings are those values beyond which device damage can occur. Maximum ratings applied to the device are individual stress limit values (not normal operating conditions) and are not valid simultaneously. If these limits are exceeded, device functional operation is not implied, damage may occur and reliability may be affected.

1. Pulse Test: Pulse Width = 5 ms, Duty Cycle $\leq 10\%$.



ON Semiconductor®

<http://onsemi.com>

**16 AMPERES
SILICON POWER TRANSISTORS
200 – 250 VOLTS, 250 WATTS**

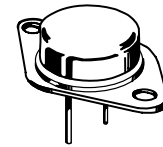

**TO-204AA (TO-3)
CASE 1-07
STYLE 1**

MARKING DIAGRAM



MJ1502x = Device Code
x = 2 or 4
G = Pb-Free Package
A = Assembly Location
Y = Year
WW = Work Week
MEX = Country of Origin

ORDERING INFORMATION

Device	Package	Shipping
MJ15022	TO-204	100 Units / Tray
MJ15022G	TO-204 (Pb-Free)	100 Units / Tray
MJ15024	TO-204	100 Units / Tray
MJ15024G	TO-204 (Pb-Free)	100 Units / Tray

Preferred devices are recommended choices for future use and best overall value.

*For additional information on our Pb-Free strategy and soldering details, please download the ON Semiconductor Soldering and Mounting Techniques Reference Manual, SOLDERRM/D.

NPN – MJ15022, MJ15024*

ELECTRICAL CHARACTERISTICS (T_C = 25°C unless otherwise noted)

Characteristic	Symbol	Min	Max	Unit
OFF CHARACTERISTICS				
Collector–Emitter Sustaining Voltage (Note 2) (I _C = 100 mA _{dc} , I _B = 0)	MJ15022 MJ15024	V _{CEO(sus)}	200 250	–
Collector Cutoff Current (V _{CE} = 200 Vdc, V _{BE(off)} = 1.5 Vdc) (V _{CE} = 250 Vdc, V _{BE(off)} = 1.5 Vdc)	MJ15022 MJ15024	I _{CEX}	– –	250 250
Collector Cutoff Current (V _{CE} = 150 Vdc, I _B = 0) (V _{CE} = 200 vdc, I _B = 0)	MJ15022 MJ15024	I _{CEO}	– –	500 500
Emitter Cutoff Current (V _{CE} = 5 Vdc, I _B = 0)		I _{EBO}	–	500
SECOND BREAKDOWN				
Second Breakdown Collector Current with Base Forward Biased (V _{CE} = 50 Vdc, t = 0.5 s (non–repetitive)) (V _{CE} = 80 Vdc, t = 0.5 s (non–repetitive))		I _{S/b}	5 2	– –
ON CHARACTERISTICS				
DC Current Gain (I _C = 8 Adc, V _{CE} = 4 Vdc) (I _C = 16 Adc, V _{CE} = 4 Vdc)		h _{FE}	15 5	60 –
Collector–Emitter Saturation Voltage (I _C = 8 Adc, I _B = 0.8 Adc) (I _C = 16 Adc, I _B = 3.2 Adc)		V _{CE(sat)}	– –	1.4 4.0
Base–Emitter On Voltage (I _C = 8 Adc, V _{CE} = 4 Vdc)		V _{BE(on)}	–	2.2
DYNAMIC CHARACTERISTICS				
Current–Gain – Bandwidth Product (I _C = 1 Adc, V _{CE} = 10 Vdc, f _{test} = 1 MHz)		f _T	4	–
Output Capacitance (V _{CB} = 10 Vdc, I _E = 0, f _{test} = 1 MHz)		C _{ob}	–	500

2. Pulse Test: Pulse Width = 300 μs, Duty Cycle ≤ 2%.

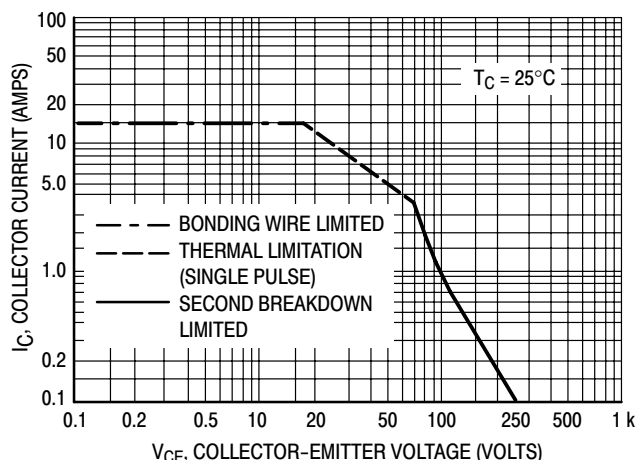

Figure 1. Active–Region Safe Operating Area

There are two limitations on the powerhandling ability of a transistor: average junction temperature and second breakdown. Safe operating area curves indicate I_C – V_{CE} limits of the transistor that must be observed for reliable operation; i.e., the transistor must not be subjected to greater dissipation than the curves indicate.

The data of Figure 1 is based on T_{J(pk)} = 200°C; T_C is variable depending on conditions. At high case temperatures, thermal limitations will reduce the power that can be handled to values I_{on} than the limitations imposed by second breakdown.

TYPICAL CHARACTERISTICS

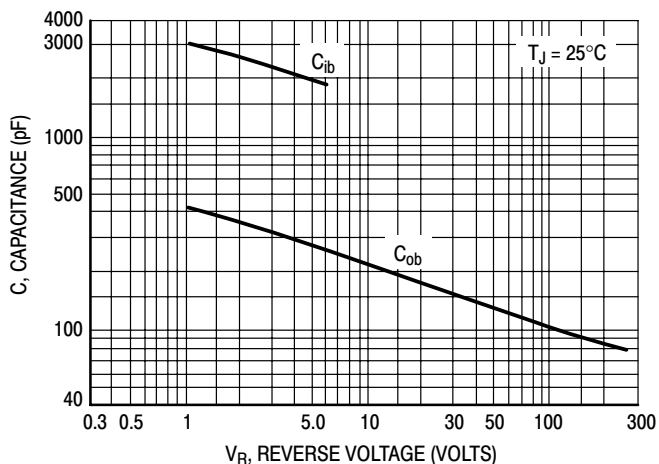

Figure 2. Capacitances

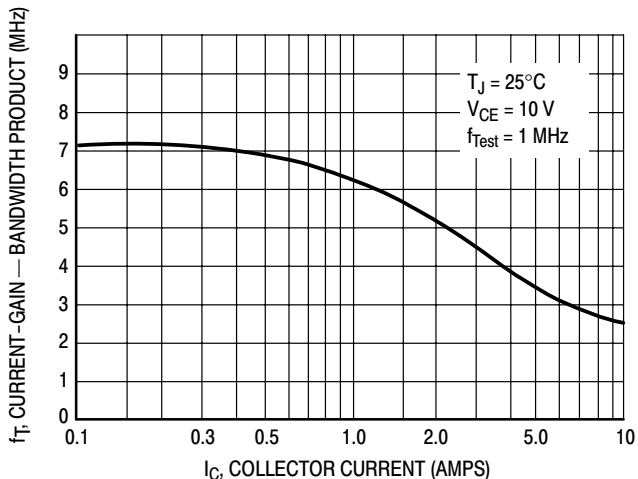

Figure 3. Current-Gain — Bandwidth Product

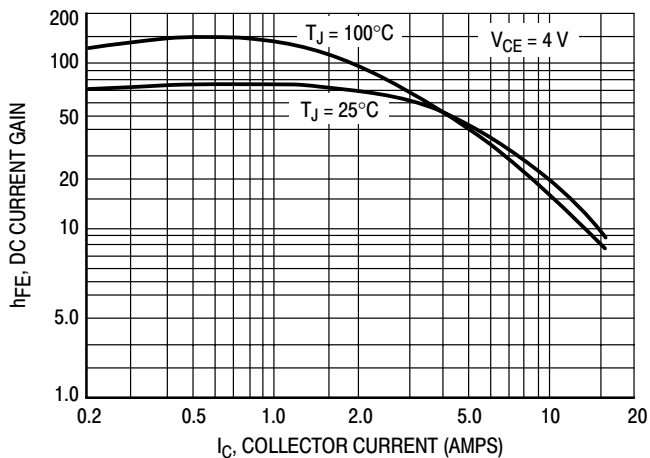

Figure 4. DC Current Gain

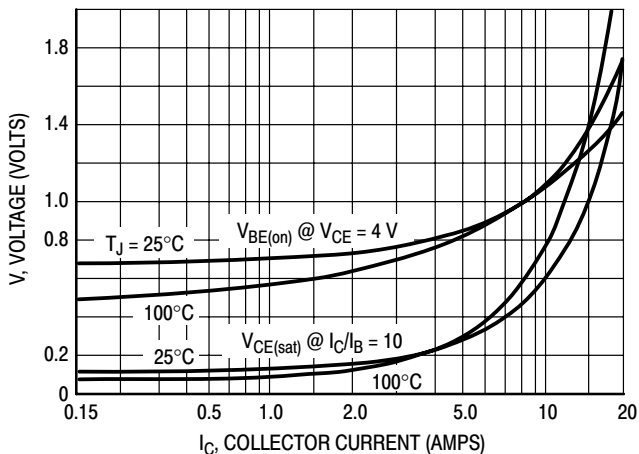

Figure 5. "On" Voltage

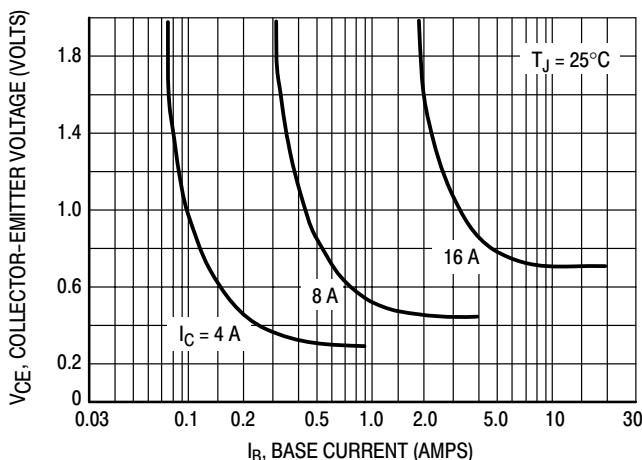
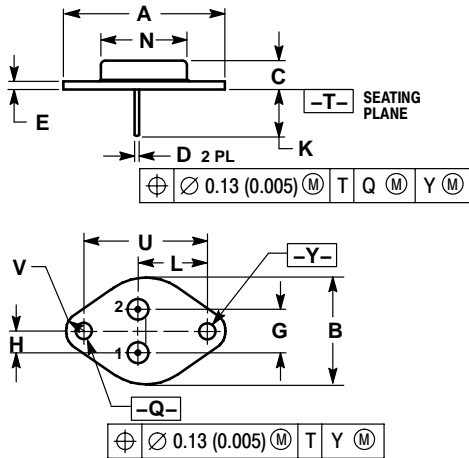

Figure 6. Collector Saturation Region

NPN – MJ15022, MJ15024*

PACKAGE DIMENSIONS

TO-204 (TO-3) CASE 1-07 ISSUE Z



NOTES:

1. DIMENSIONING AND TOLERANCING PER ANSI Y14.5M, 1982.
2. CONTROLLING DIMENSION: INCH.
3. ALL RULES AND NOTES ASSOCIATED WITH REFERENCED TO-204AA OUTLINE SHALL APPLY.

DIM	INCHES		MILLIMETERS	
	MIN	MAX	MIN	MAX
A	1.550 REF		39.37 REF	
B	---	1.050	---	26.67
C	0.250	0.335	6.35	8.51
D	0.038	0.043	0.97	1.09
E	0.055	0.070	1.40	1.77
G	0.430 BSC		10.92 BSC	
H	0.215 BSC		5.46 BSC	
K	0.440	0.480	11.18	12.19
L	0.665 BSC		16.89 BSC	
N	---	0.830	---	21.08
Q	0.151	0.165	3.84	4.19
U	1.187 BSC		30.15 BSC	
V	0.131	0.188	3.33	4.77

STYLE 1:

1. BASE
 2. EMITTER
- CASE: COLLECTOR

ON Semiconductor and are registered trademarks of Semiconductor Components Industries, LLC (SCILLC). SCILLC reserves the right to make changes without further notice to any products herein. SCILLC makes no warranty, representation or guarantee regarding the suitability of its products for any particular purpose, nor does SCILLC assume any liability arising out of the application or use of any product or circuit, and specifically disclaims any and all liability, including without limitation special, consequential or incidental damages. "Typical" parameters which may be provided in SCILLC data sheets and/or specifications can and do vary in different applications and actual performance may vary over time. All operating parameters, including "Typicals" must be validated for each customer application by customer's technical experts. SCILLC does not convey any license under its patent rights nor the rights of others. SCILLC products are not designed, intended, or authorized for use as components in systems intended for surgical implant into the body, or other applications intended to support or sustain life, or for any other application in which the failure of the SCILLC product could create a situation where personal injury or death may occur. Should Buyer purchase or use SCILLC products for any such unintended or unauthorized application, Buyer shall indemnify and hold SCILLC and its officers, employees, subsidiaries, affiliates, and distributors harmless against all claims, costs, damages, and expenses, and reasonable attorney fees arising out of, directly or indirectly, any claim of personal injury or death associated with such unintended or unauthorized use, even if such claim alleges that SCILLC was negligent regarding the design or manufacture of the part. SCILLC is an Equal Opportunity/Affirmative Action Employer. This literature is subject to all applicable copyright laws and is not for resale in any manner.

PUBLICATION ORDERING INFORMATION

LITERATURE FULFILLMENT:
Literature Distribution Center for ON Semiconductor
P.O. Box 61312, Phoenix, Arizona 85062-1312 USA
Phone: 480-829-7710 or 800-344-3860 Toll Free USA/Canada
Fax: 480-829-7709 or 800-344-3867 Toll Free USA/Canada
Email: orderlit@onsemi.com

N. American Technical Support: 800-282-9855 Toll Free
USA/Canada

Japan: ON Semiconductor, Japan Customer Focus Center
2-9-1 Kamimeguro, Meguro-ku, Tokyo, Japan 153-0051
Phone: 81-3-5773-3850

ON Semiconductor Website: <http://onsemi.com>

Order Literature: <http://www.onsemi.com/litorder>

For additional information, please contact your local Sales Representative.