



HESTORE.HU

elektronikai alkatrész áruház

EN: This Datasheet is presented by the manufacturer.

Please visit our website for pricing and availability at www.hestore.hu.

PDA54-11EWA/SRWA/YWA/GWA
 PDC54-11EWA/SRWA/YWA/GWA
 PDA54-12EWA/SRWA/YWA/GWA
 PDC54-12EWA/SRWA/YWA/GWA

Features

- 0.54 INCH CHARACTER HEIGHT.
- LOW CURRENT OPERATION.
- HIGH CONTRAST AND LIGHT OUTPUT.
- COMMON ANODE AVAILABLE.
- EASY MOUNTING ON P.C. BOARDS OR SOCKETS.
- CATEGORIZED FOR LUMINOUS INTENSITY.
- MECHANICALLY RUGGED.
- STANDARD: GRAY FACE, WHITE SEGMENT.

Description

The High Efficiency Red source color devices are made with Gallium Arsenide Phosphide on Gallium Phosphide Orange Light Emitting Diode.

The Super Bright Red source color devices are made with Gallium Aluminum Arsenide Red Light Emitting Diode. The Yellow source color devices are made with Gallium Arsenide Phosphide on Gallium Phosphide Yellow Light Emitting Diode.

The Green source color devices are made with Gallium Phosphide Green Light Emitting Diode.

Package Dimensions & Internal Circuit Diagram

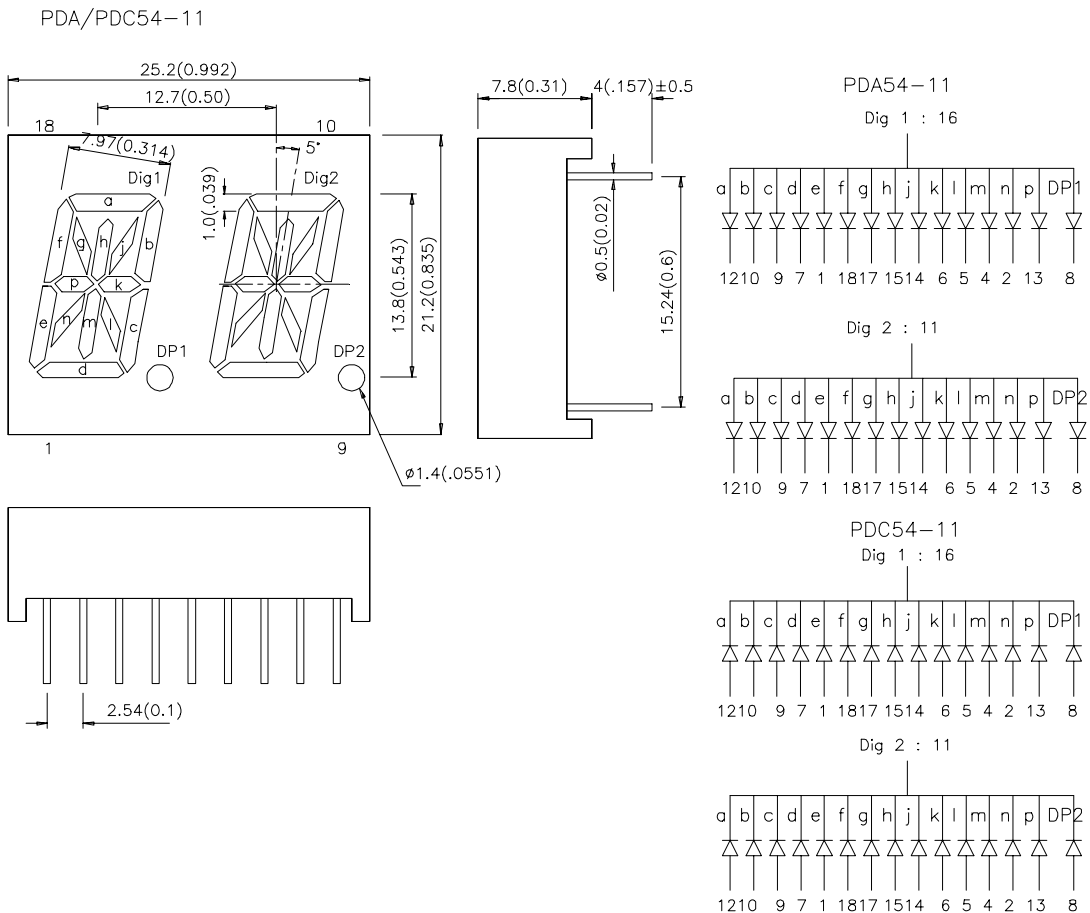

Package Dimensions & Internal Circuit Diagram

PDA/PDC54-12

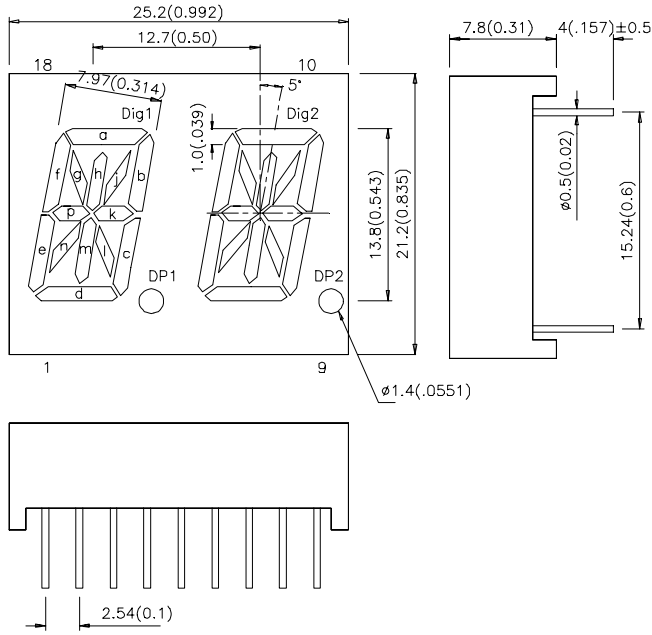

PDC54-12

Fig. 1

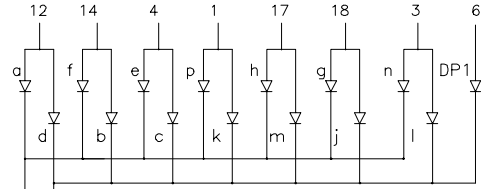
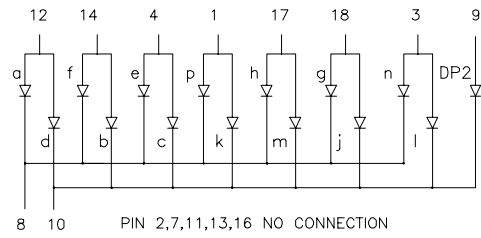

Fig. 2



PDA54-12

Fig. 1

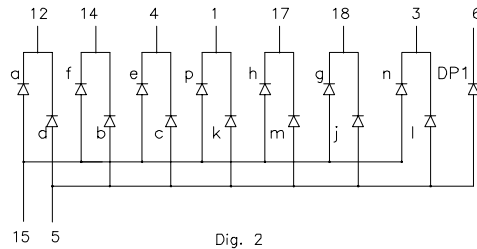
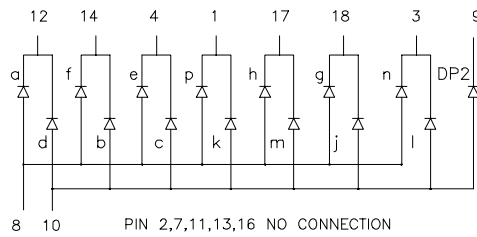

Fig. 2



Notes:

1. All dimensions are in millimeters (inches), Tolerance is $\pm 0.25(0.01)$ unless otherwise noted.
2. Specifications are subject to change without notice.

Selection Guide

Part No.	Dice	Lens Type	Iv (ucd) @ 10 mA		Description
			Min.	Typ.	
PDA54-11EWA	HIGH EFFICIENCY RED (GaAsP/GaP)	WHITE DIFFUSED	1900	4700	Common Anode, Rt. Hand Decimal
PDA54-12EWA					Common Cathode, Rt. Hand Decimal
PDC54-11EWA					
PDC54-12EWA					
PDA54-11SRWA	SUPER BRIGHT RED (GaAlAs)	WHITE DIFFUSED	8000	18000	Common Anode, Rt. Hand Decimal
PDA54-12SRWA					Common Cathode, Rt. Hand Decimal
PDC54-11SRWA					
PDC54-12SRWA					
PDA54-11YWA	YELLOW (GaAsP/GaP)	WHITE DIFFUSED	1200	3000	Common Anode, Rt. Hand Decimal
PDA54-12YWA					Common Cathode, Rt. Hand Decimal
PDC54-11YWA					
PDC54-12YWA					
PDA54-11GWA	GREEN (GaP)	WHITE DIFFUSED	3000	8000	Common Anode, Rt. Hand Decimal
PDA54-12GWA					Common Cathode, Rt. Hand Decimal
PDC54-11GWA					
PDC54-12GWA					

Electrical / Optical Characteristics at T_A=25°C

Symbol	Parameter	Device	Typ.	Max.	Units	Test Conditions
λ_{peak}	Peak Wavelength	High Efficiency Red Super Bright Red Yellow Green	627 660 590 565		nm	I _F =20mA
λ_D	Dominant Wavelength	High Efficiency Red Super Bright Red Yellow Green	625 640 588 568		nm	I _F =20mA
$\Delta\lambda_{1/2}$	Spectral Line Half-width	High Efficiency Red Super Bright Red Yellow Green	45 20 35 30		nm	I _F =20mA
C	Capacitance	High Efficiency Red Super Bright Red Yellow Green	15 45 20 15		pF	V _F =0V;f=1MHz
V _F	Forward Voltage	High Efficiency Red Super Bright Red Yellow Green	2.0 1.85 2.1 2.2	2.5 2.5 2.5 2.5	V	I _F =20mA
I _R	Reverse Current	All		10	uA	V _R = 5V

Absolute Maximum Ratings at $T_A=25^\circ\text{C}$

Parameter	High Efficiency Red	Super Bright Red	Yellow	Green	Units
Power dissipation	105	100	105	105	mW
DC Forward Current	30	30	30	25	mA
Peak Forward Current [1]	160	155	140	140	mA
Reverse Voltage	5	5	5	5	V
Operating/Storage Temperature	-40°C To +85°C				
Lead Solder Temperature [2]	260°C For 5 Seconds				

Notes:

- 1/10 Duty Cycle, 0.1ms Pulse Width.
- 2mm below package base.

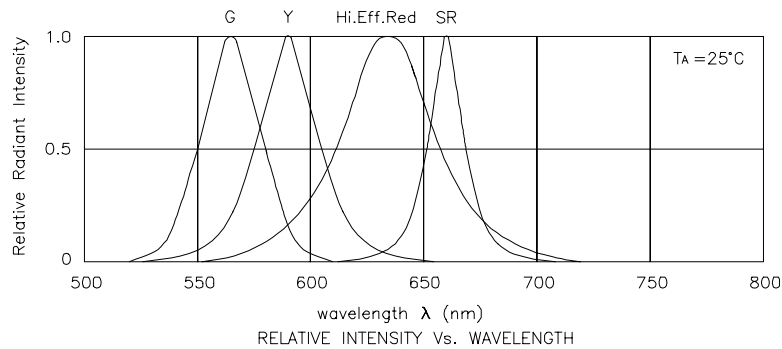

High Efficiency Red

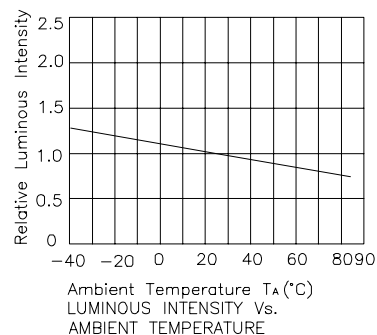
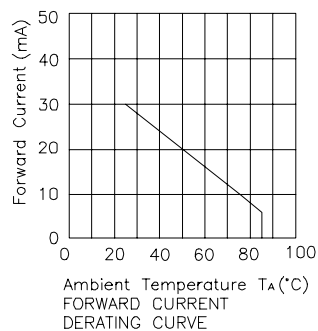
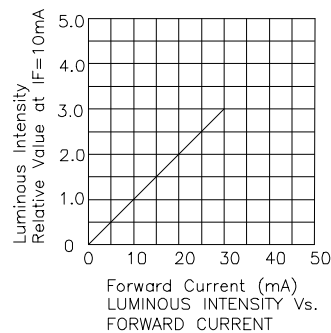
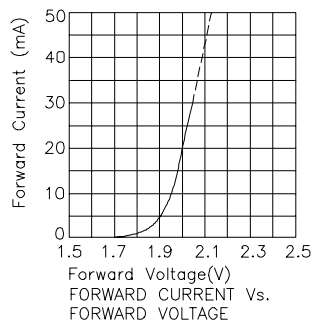

Super Bright Red

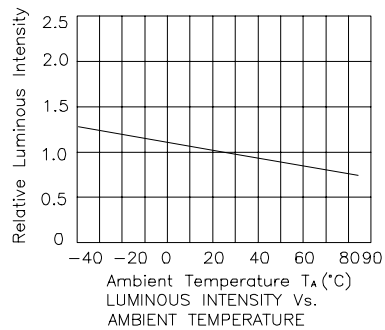
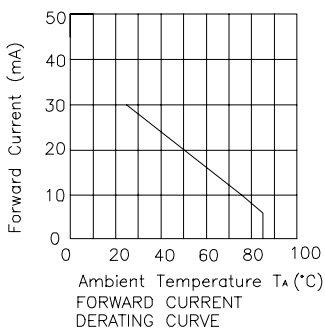
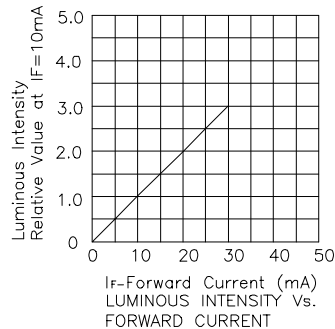
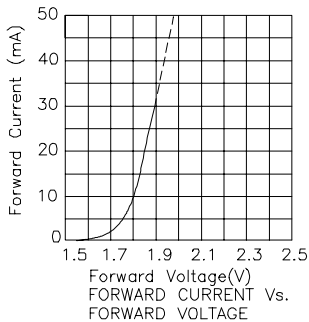

Yellow

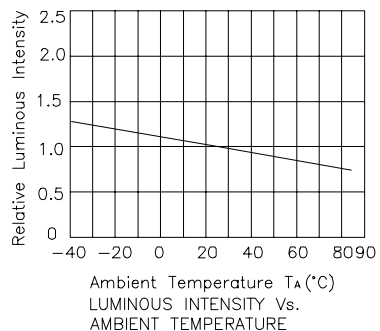
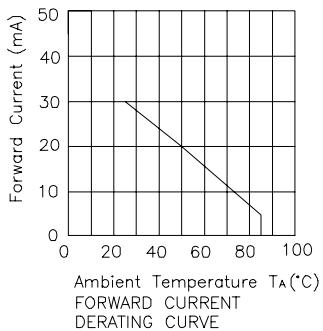
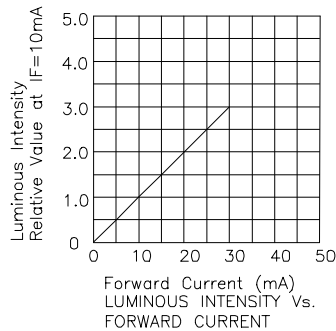
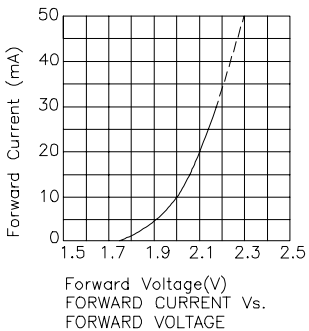

Green

