



HESTORE.HU

elektronikai alkatrész áruház

EN: This Datasheet is presented by the manufacturer.

Please visit our website for pricing and availability at www.hestore.hu.

NE5532

Dual Operational Amplifier

Features

- Internal Frequency Compensation
- Slew Rate: $8V/\mu s$
- Input Noise Voltage: $8nV/\sqrt{Hz}$ ($f_o = 30Hz$)
- Full Power Bandwidth: 140KHz

Description

The NE5532 is an internally compensated dual low noise OP-AMP. The high small signal and power bandwidth provides superior performance in high quality AMP, all control circuits, and telephone applications.

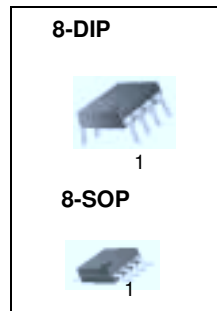

Internal Block Diagram

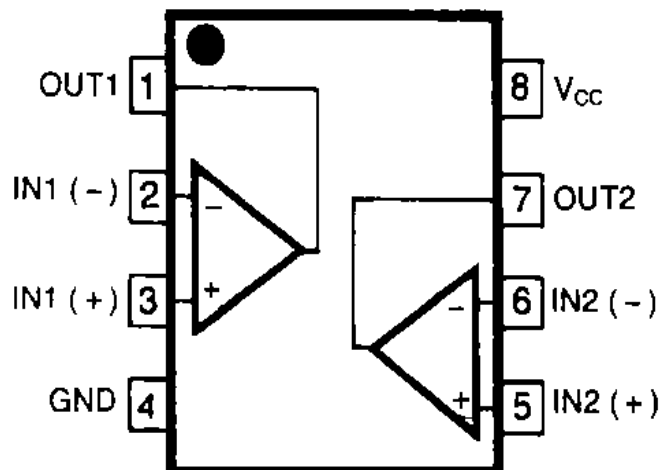

Absolute Maximum Ratings

Parameter	Symbol	NE5532	Unit
Power Supply Voltage	V _{CC}	±22	V
Differential Input Voltage	V _(DIFF)	±13	V
Input Voltage	V _I	Supply Voltage	V
Power Dissipation, T _A = 25°C 8-DIP 8-SOP	P _D	1100 500	mW
Operating Temperature Range	TOPR	0 ~ + 70	°C

Thermal Data

Parameter	Symbol	Value	Unit
Thermal Resistance Junction-Ambient Max. 8-DIP 8-SOP	R _{θja}	110 250	°C/W

Electrical Characteristics

(V_{CC}=15V, V_{EE}= - 15V, T_A = 25°C)

Parameter	Symbol	Conditions	Min.	Typ.	Max.	Unit
Input Offset Voltage	V _{IO}	-	-	0.5	4.0	mV
Input Offset Current	I _{IO}	-	-	10	150	nA
Input Bias Current	I _{BIAS}	-	-	200	800	nA
Supply Current	I _{CC}	-	-	6.0	16	mA
Input Voltage Range	V _{I(R)}	-	±12	±13	-	V
Common Mode Rejection Range	CMRR	T _A = 25 °C	70	100	-	dB
Power Supply Rejection Ratio	PSRR	T _A = 25 °C	80	100	-	dB
Output Voltage Swing	V _{O(P-P)}	R _L ≥ 600Ω	±12	±13	-	V
Input Resistance	R _I	T _A = 25 °C	30	300	-	KΩ
Short Circuit Current	I _{SC}	-	-	38	-	mA
Overshoot	OS	R _L =600Ω, C _L =100pF	-	10	20	%
Voltage Gain	G _V	f = 10KHz	2	2.2	-	V/mV
Gain Bandwidth Product	GBW	C _L =100pF, R _L = 600Ω	8	10	-	MHz
Slew Rate	SR	R _L =1K, C _L =100pF, R _L =600Ω	6	8.0	-	V/μs
Input Noise Voltage	e _N	f _O = 30Hz f _O = 1KHz	-	8.0 5.0	-	nV/√Hz

Typical Performance Characteristics

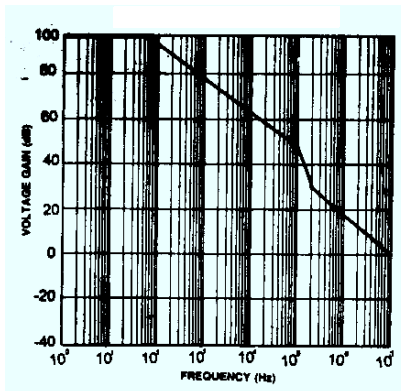

Figure 1. Open Loop Frequency Response

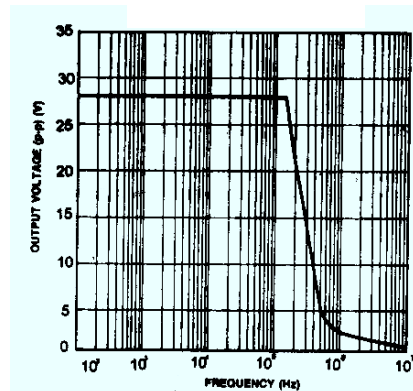

Figure 2. Large Signal Frequency Response

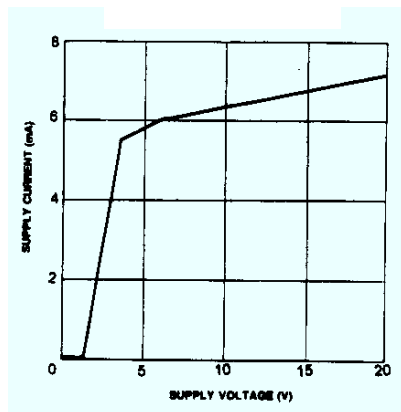

Figure 3. Supply Current vs Supply Voltage

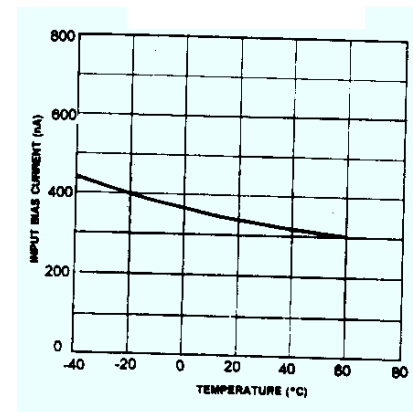

Figure 4. Input Bias Current vs Temperature

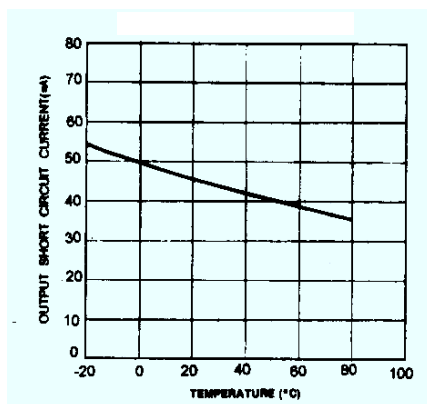

Figure 5. Output Circuit Current vs Temperature

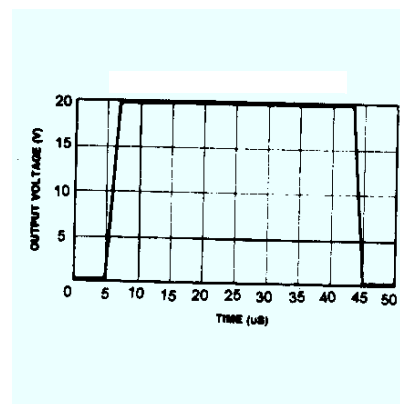

Figure 6. Slew Rate

Mechanical Dimensions

Package

Dimensions in millimeters

8-DIP

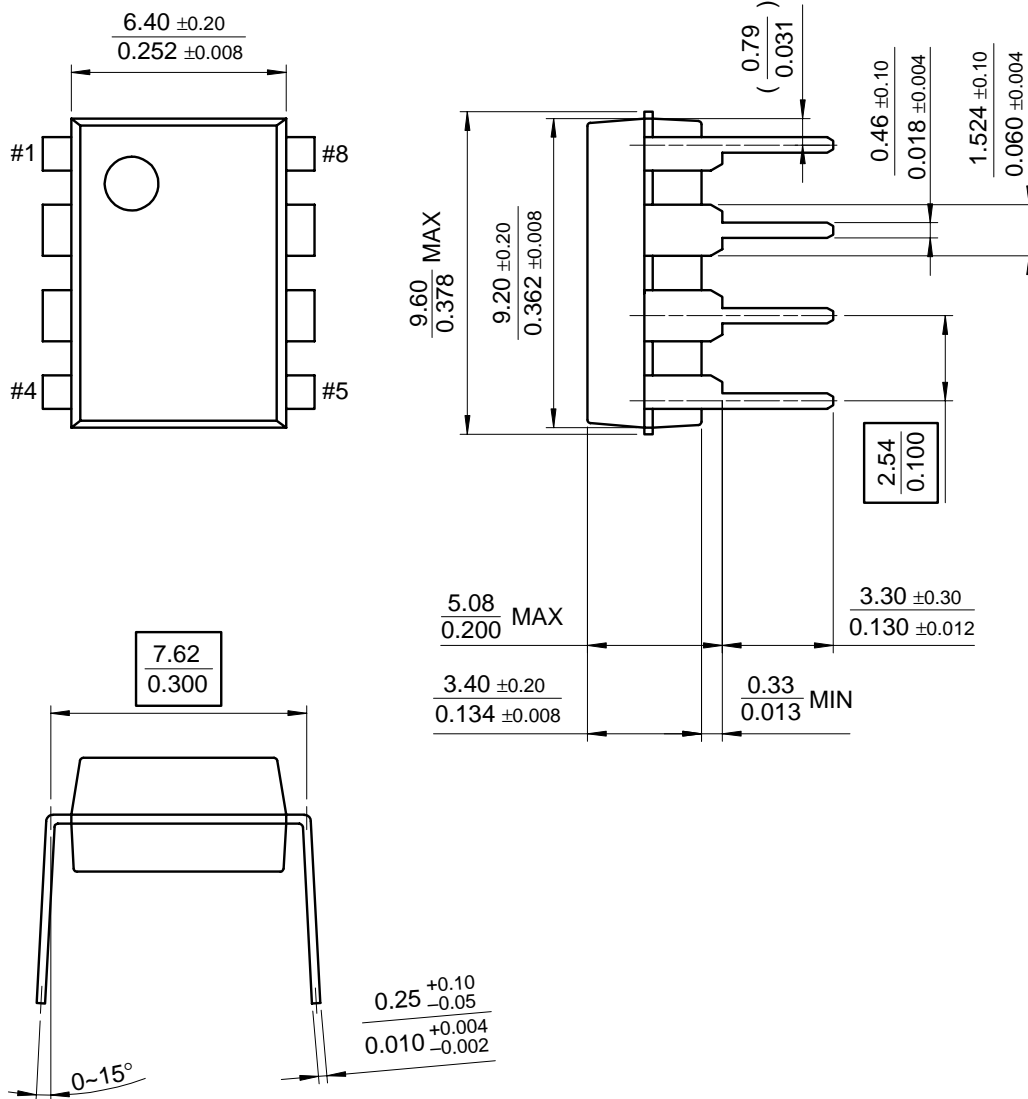

Mechanical Dimensions (Continued)

Package

Dimensions in millimeters

8-SOP

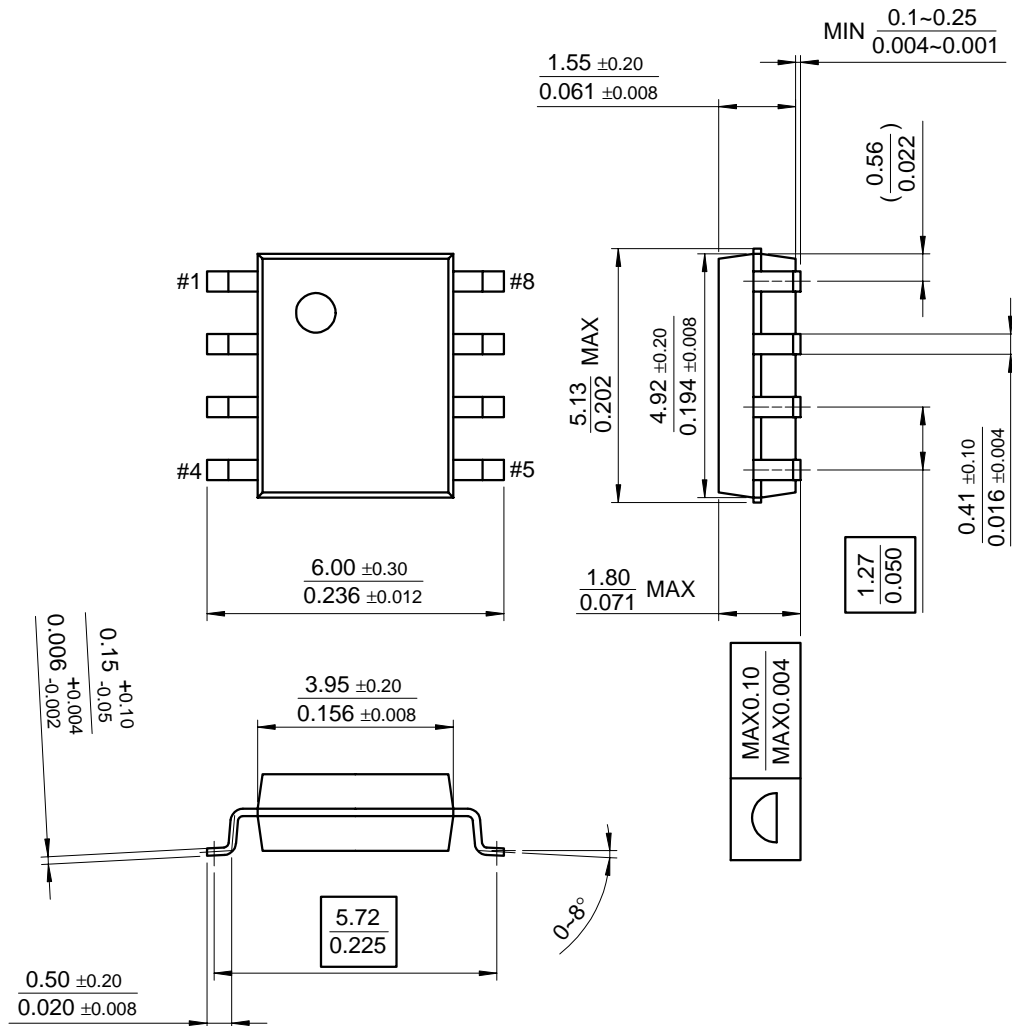

Ordering Information

Product Number	Package	Operating Temperature
NE5532N	8-DIP	0 ~ +70°C
NE5532D	8-SOP	

DISCLAIMER

FAIRCHILD SEMICONDUCTOR RESERVES THE RIGHT TO MAKE CHANGES WITHOUT FURTHER NOTICE TO ANY PRODUCTS HEREIN TO IMPROVE RELIABILITY, FUNCTION OR DESIGN. FAIRCHILD DOES NOT ASSUME ANY LIABILITY ARISING OUT OF THE APPLICATION OR USE OF ANY PRODUCT OR CIRCUIT DESCRIBED HEREIN; NEITHER DOES IT CONVEY ANY LICENSE UNDER ITS PATENT RIGHTS, NOR THE RIGHTS OF OTHERS.

LIFE SUPPORT POLICY

FAIRCHILD'S PRODUCTS ARE NOT AUTHORIZED FOR USE AS CRITICAL COMPONENTS IN LIFE SUPPORT DEVICES OR SYSTEMS WITHOUT THE EXPRESS WRITTEN APPROVAL OF THE PRESIDENT OF FAIRCHILD SEMICONDUCTOR CORPORATION. As used herein:

1. Life support devices or systems are devices or systems which, (a) are intended for surgical implant into the body, or (b) support or sustain life, and (c) whose failure to perform when properly used in accordance with instructions for use provided in the labeling, can be reasonably expected to result in a significant injury of the user.
2. A critical component in any component of a life support device or system whose failure to perform can be reasonably expected to cause the failure of the life support device or system, or to affect its safety or effectiveness.