



**HESTORE.HU**

elektronikai alkatrész áruház

**EN:** This Datasheet is presented by the manufacturer.

Please visit our website for pricing and availability at [www.hestore.hu](http://www.hestore.hu).

# BASICR4(EN)



Wi-Fi Smart Switch

User Manual V1.0

## Introduction

A Wi-Fi smart switch integrating APP remote control, voice control, timer and other functions. You can control your home appliances anytime, anywhere, and also create a variety of smart scenes to facilitate your life.



Remote Control



Voice Control



Timer Schedule



LAN Control

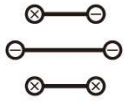

Power-on State



Smart Scene

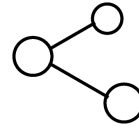

Share Device

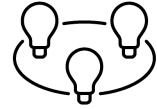

Create Group

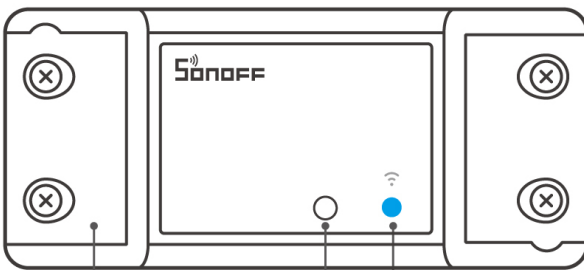

③

④

①

②

### ① Button

Single press: Changing the on/off state of relay contacts

Long press for 5s: Enter pairing mode

### ② Wi-Fi LED indicator (Blue)

- Flashes two short and one long: Device is in pairing mode.
- Keeps on: Online
- Flashes once: Offline
- Flashes twice: LAN
- Flashes three times: OTA
- Keep flashing: Overheat protection

### ③ Wiring ports

### ④ Protective cover

## Compatible Voice Assistants



# Specification

Model	BASICR4
MCU	ESP32-C3FN4
Input	100-240V ~ 50/60Hz Max 10A
Output	100-240V ~ 50/60Hz Max 10A
Max. power	2400W@240V
Wireless Connectivity	Wi-Fi IEEE 802.11b/g/n 2.4GHz
Net weight	45.8g
Product dimension	88x39x24mm
Color	White
Casing material	PC V0
Applicable place	Indoor
Working temperature	-10°C~40°C
Working humidity	10%~95% RH, non-condensing
Certification	ISED/FCC/RoHS/ETL/CE/SRRC
Executive standard	EN IEC 60669-2-1, UL 60730-1, CSA E 60730-1

## Installation

### 1. Power off

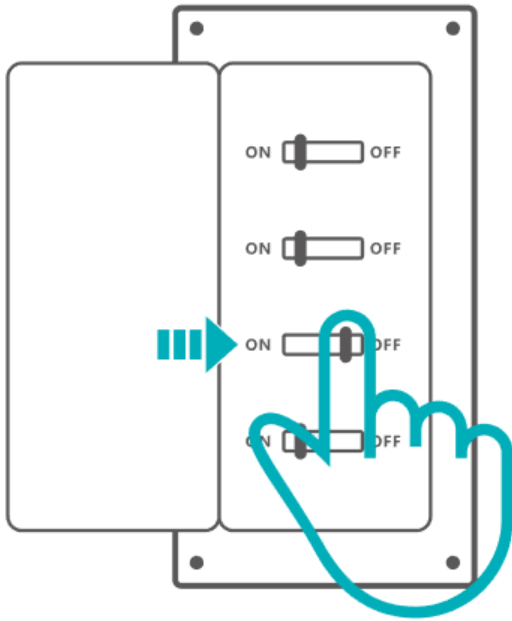

*\*Please install and maintain the device by a professional electrician. To avoid electric shock hazard, do not operate any connection or contact the terminal connector while the device is powered on!*

## 2. Wiring instruction

To ensure the safety of your electrical installation, it's essential either a Miniature Circuit Breaker (MCB) or a Residual Current Operated Circuit Breaker (RCBO) with an electrical rating of 10A has been installed before the BASICR4.

Wiring: 16–18AWG SOL/STR copper conductor only, Tightening torque: 3.5 lb–in

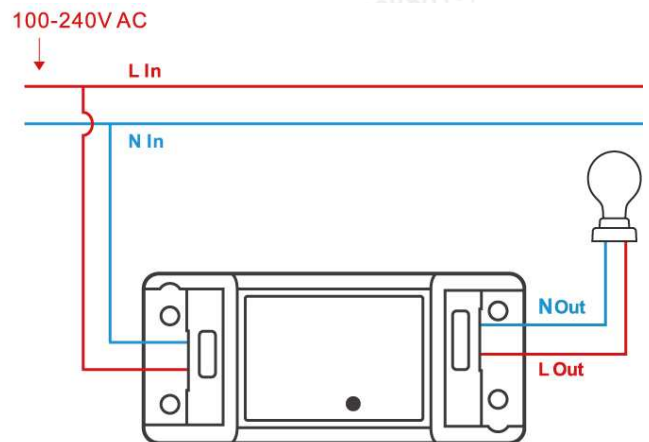
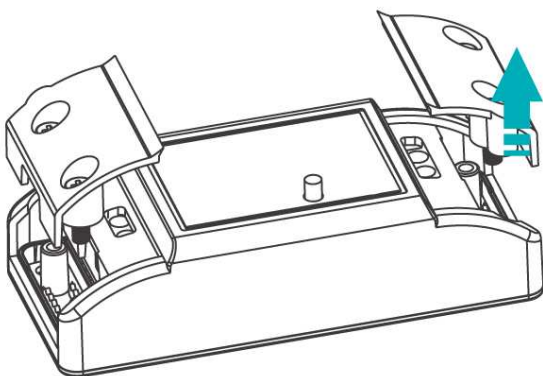

- Make sure all wires are connected correctly.

### 3. Power on

After powering on, the device will enter the Pairing Mode defaulted during the first use, and the LED indicator flashes in a cycle of two short and one long.

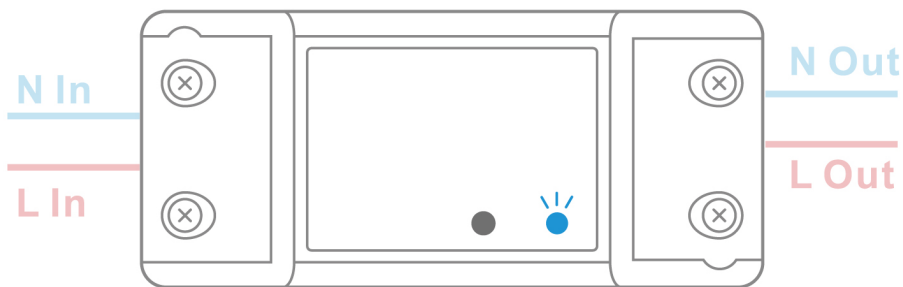
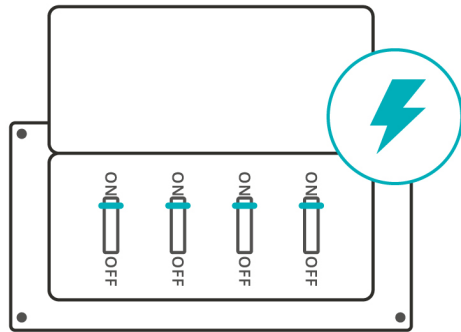

*\*The device will exit the Pairing Mode if it is not paired within 10mins. If you want to enter this mode again, please long press the button for 5s until the LED indicator flashes in a cycle of two short and one long and then release.*

## Add device

### 1. Download the eWeLink App

Please download the "eWeLink" App from [Google Play Store](#) or [Apple App Store](#).

### 2.Add device

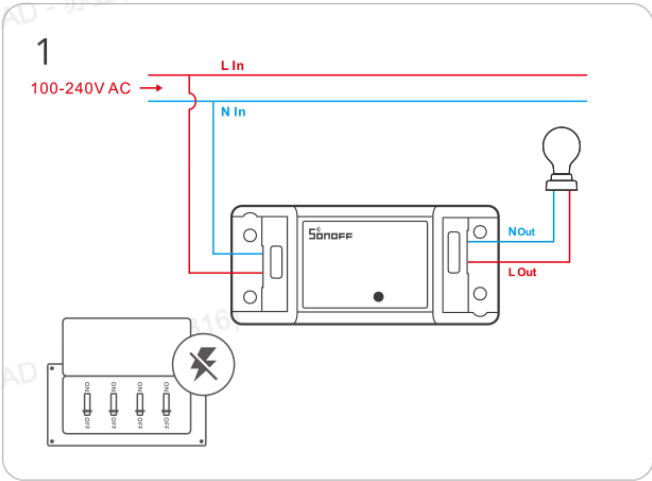

Please follow the wiring instructions to connect the wires (ensure power is disconnected in advance and consult an electrician if needed)

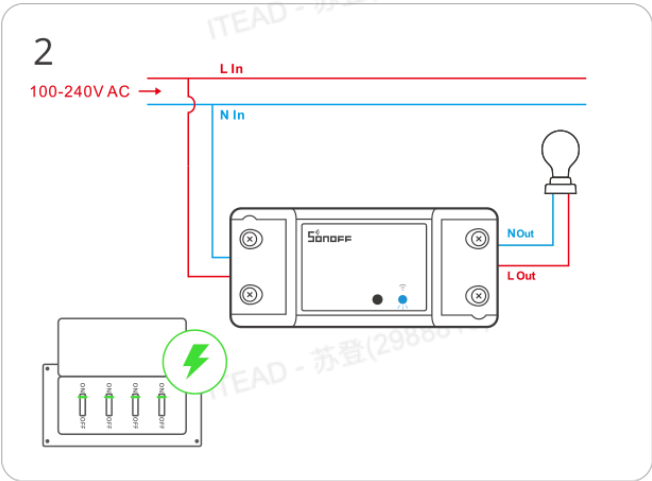

Power on the device

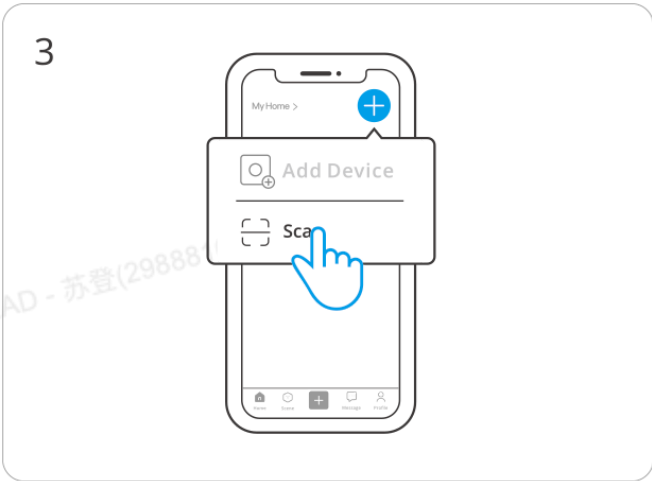

Enter "Scan"

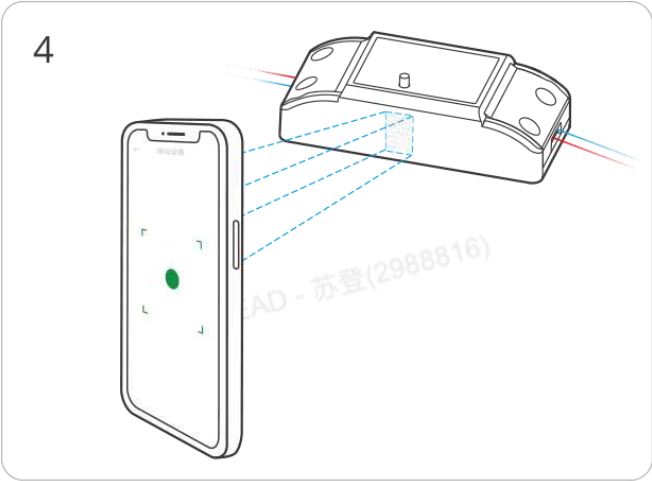

Scan the BASICR4 QR code on the device body



Select "Add Device"

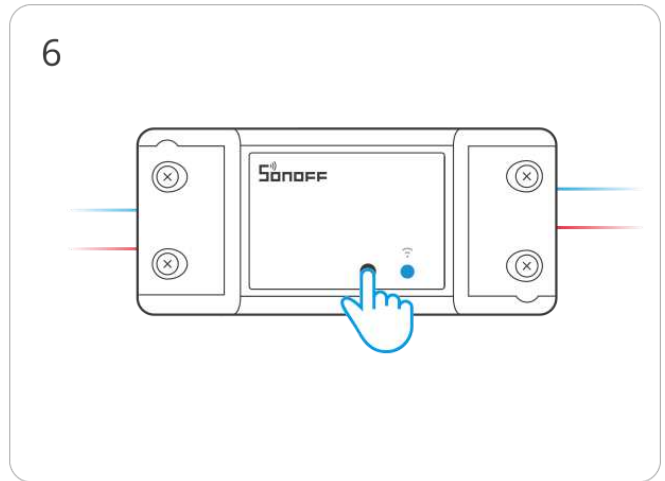

Long press the button for 5 seconds

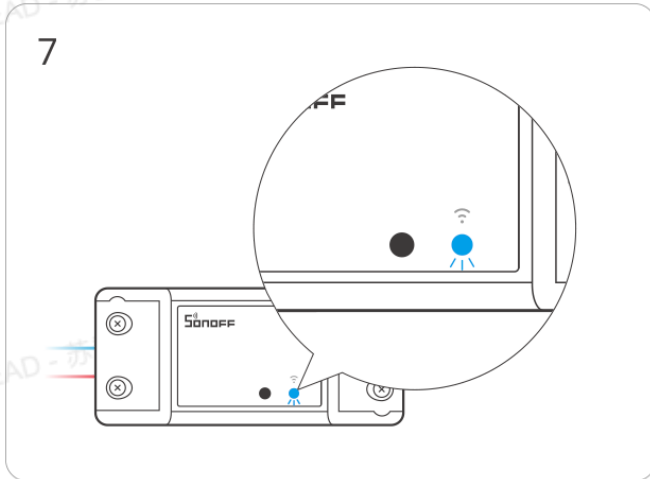

Check Wi-Fi LED indicator flashing status  
(Two short and one long)



Search for the device and start connecting



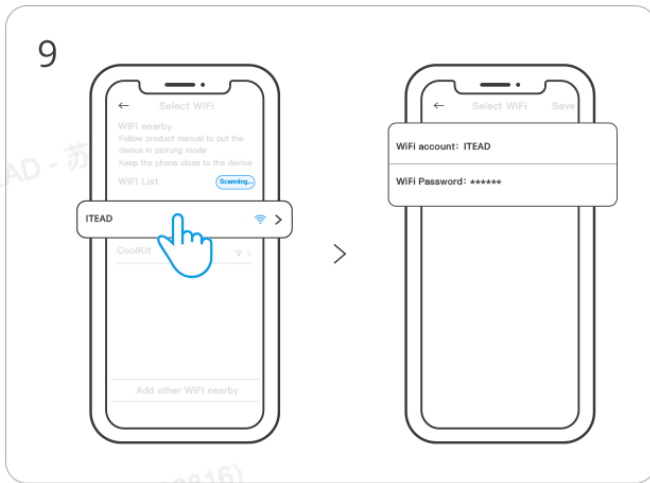

Select the "Wi-Fi" network and enter the password.

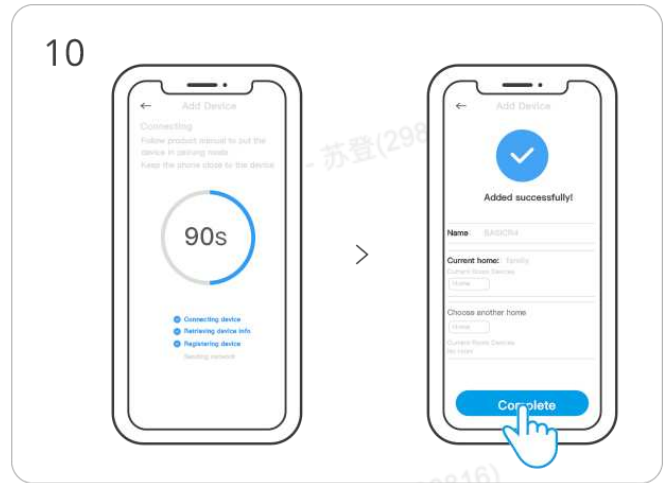

Device "Added completely".

## Installation and use

### 1. Lay flat before use

### 2. Use of Fixing Screws

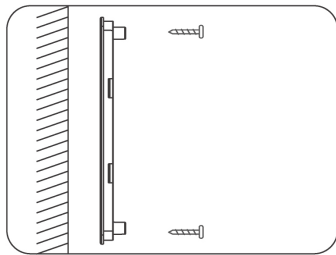

① Screw the lower cover to the wall

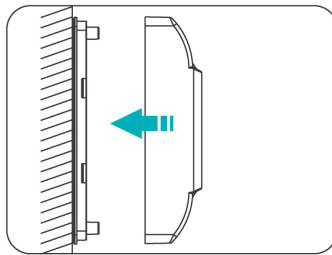

② Close the upper cover

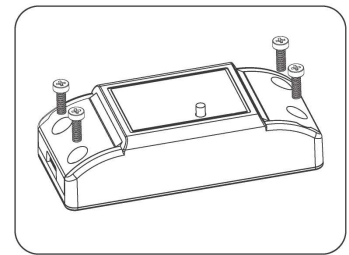

③ Secure the protective cover with screws

## Device function

### 1. Magic Switch Mode

After short-circuiting the L1 and L2 of the switch terminals through the wires, the device can still be online and can be controlled through the APP after the users flip the wall switch to turn off/on the light.

- Add a wire to connect L1 to L2 on the wall switch following the manual, and the device will stay online even when you switch it off via the wall switch after “Magic Switch Mode” enabled.
- The “Power-on State” will automatically be set to OFF, to make the “Magic Switch Mode” functional when enabled.
- The “Magic Switch Mode” will automatically disable after your adjustment to the “Power-on State”.

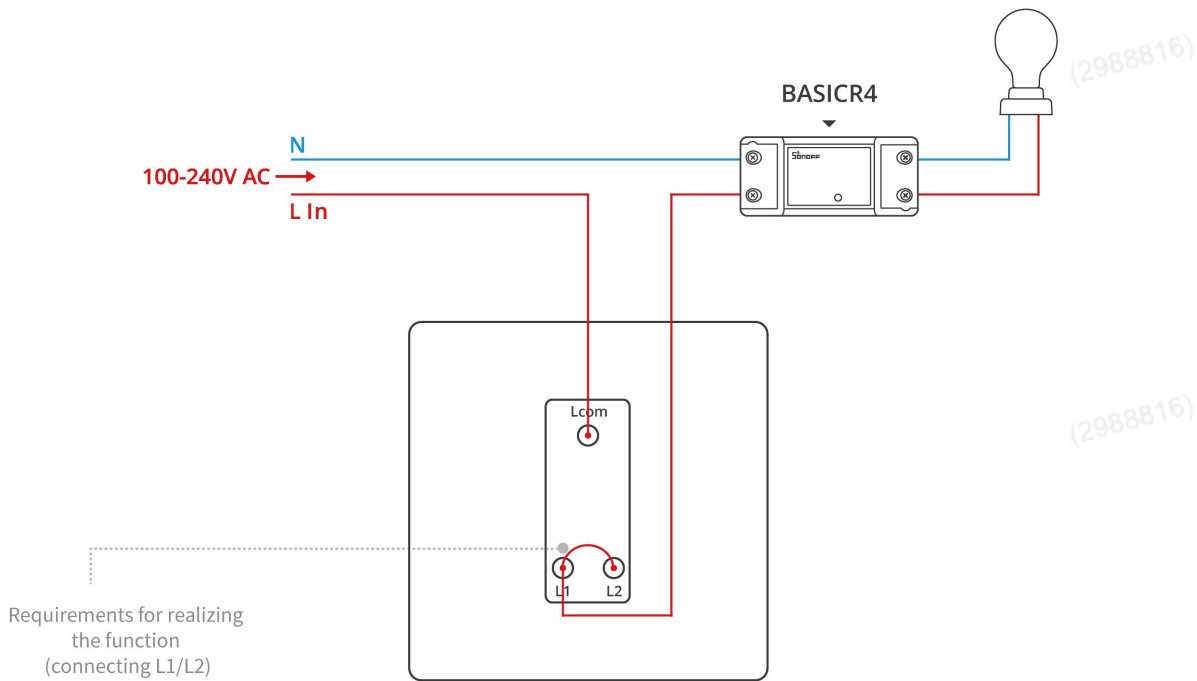

Note: Only compatible with mainstream brands of double pole rocker switches. The rear-end light needs to be compatible with mainstream brands of LED, energy-saving lamps, and incandescent lamps ranging from 3W to 100W.

\*This function also applies to dual-control lamps

## 2.Auxiliary overheating protection

With the product built-in temperature sensor, real-time maximum temperature of the entire product can be detected and speculated, which prevents the product from deformation, melting, fire or live devices exposing in case of over-temperature.

The device automatically cuts off the load when it gets too hot. To exit the overheating protection mode, simply press the button on the device after confirming that the load is functioning normally without any internal shorts, excessive power, or leaks.

*\*Please note that this function only serves as auxiliary protection and cannot be used in place of a circuit breaker.*

## Device Network Changing

Change the device's network by "Wi-Fi Settings" in the "Device Settings" page on the eWeLink App.

## Factory Reset

Reset the device to factory settings by "Delete device" in the eWeLink App.

## FAQ

### Fail to pair Wi-Fi devices with the eWeLink App

1. Make sure the device is in pairing mode.

The device will automatically exit the pairing mode if it is not paired within 10mins.

2. Please enable location service and allow access to location permission.

Before connecting Wi-Fi network, please enable the location service and allow access to the location permission. Location information permission is used to obtain Wi-Fi list

information, if you "disable" the location service, the device cannot be paired.

3. Make sure your Wi-Fi works on 2.4GHz band.

4. Make sure to enter the Wi-Fi SSID and password correctly without special characters.

Incorrect password is a common cause of pairing failure.

5. To ensure good signal transmission while pairing, please place the device close to the router.

### **The LED indicator flashes twice on repeated means the server fails to connect.**

1. Make sure the networking is normal. Check the internet works well by connecting your phone or PC. If fail to connect, please check the availability of the Internet connection.

2. Please check the maximum number of devices that can be connected to your router. If your router has a low capacity and the number of devices connected to it exceeds the maximum, remove some devices or use a higher-capacity router.

If the above methods cannot help to solve the problem, please submit your problem to "Help & Feedback" on the eWeLink App.

### **Wi-Fi devices are "offline"**

1. Devices fail to connect to the router.

2. Entered the wrong Wi-Fi SSID and password.

3. Wi-Fi SSID and password contain special characters, for example, our system can't recognize Hebrew and Arabic characters, which causes Wi-Fi connections to fail.

4. Low capacity of the router.

5. Wi-Fi signal is weak. The router and the devices are too far apart, or there is an obstacle between the router and the device, which prevents the signal from being transmitted.

---

## **FCC Warning**

This device complies with part 15 of the FCC Rules. Operation is subject to the following two conditions:

(1) This device may not cause harmful interference, and

(2) This device must accept any interference received, including interference that may cause undesired operation.

2. Changes or modifications not expressly approved by the party responsible for compliance could void the user's authority to operate the equipment.

Note: This equipment has been tested and found to comply with the limits for a Class B digital device, pursuant to part 15 of the FCC Rules. These limits are designed to provide reasonable protection against harmful interference in a residential installation. This equipment generates, uses and can radiate radio frequency energy and, if not installed and used in accordance with the instructions, may cause harmful interference to radio communications. However, there is no guarantee that interference will not occur in a particular installation. If this equipment does cause harmful interference to radio or television reception, which can be determined by turning the equipment off and on, the user is encouraged to try to correct the interference by one or more of the following measures:

—Reorient or relocate the receiving antenna.

—Increase the separation between the equipment and receiver.

—Connect the equipment into an outlet on a circuit different from that to which the receiver is connected.

—Consult the dealer or an experienced radio/TV technician for help.

FCC Radiation Exposure Statement:

This equipment complies with FCC radiation exposure limits set forth for an uncontrolled environment. This equipment should be installed and operated with minimum distance of 20 cm between the radiator and your body. This transmitter must not be co-located or operating in conjunction with any other antenna or transmitter.

---

ISED Notice

This device contains licence-exempt transmitter(s)/receiver(s) that comply with Innovation, Science and Economic Development Canada's licence-exempt RSS(s).

Operation is subject to the following two conditions:

(1) This device may not cause interference.

(2) This device must accept any interference, including interference that may cause undesired operation of the device.

This Class B digital apparatus complies with Canadian ICES-003.

This device complies with RSS-247 of Industry Canada.

Operation is subject to the condition that this device does not cause harmful interference.

L'émetteur/récepteur exempt de licence contenu dans le présent appareil est conforme aux CNR d'Innovation, Sciences et Développement économique Canada applicables aux appareils radio

exempts de licence. L'exploitation est autorisée aux deux conditions suivantes :

(1) L'appareil ne doit pas produire de brouillage;

(2) L'appareil doit accepter tout brouillage radioélectrique subi, même si le brouillage est susceptible d'en compromettre le fonctionnement.

Cet appareil numérique de la Classe B conforme à la norme NMB-003 du Canada.

Cet appareil est conforme à la norme RSS-247 d'Industrie Canada. Le fonctionnement est soumis à la condition que cet appareil ne provoque pas d'interférences nuisibles.

ISED Radiation Exposure Statement

This equipment complies with ISED radiation exposure limits set forth for an uncontrolled environment.

This equipment should be installed and operated with minimum distance of 20 cm between the radiator and your body.

This transmitter must not be co-located or operating in conjunction with any other antenna or transmitter.

Cet équipement est conforme aux limites d'exposition aux rayonnements de la ISED établies pour un environnement non contrôlé.

Cet équipement doit être installé et fonctionner à au moins 20cm de distance d'un radiateur ou de votre corps.

Cet émetteur ne doit pas être co-localisé ou fonctionner en conjonction avec une autre antenne ou un autre émetteur.

---

## SAR Warning

Under normal use of condition, this equipment should be kept a separation distance of at least 20cm between the antenna and the body of the user.

Dans des conditions normales d'utilisation, cet équipement doit être maintenu à une distance d'au moins 20 cm entre l'antenne et le corps de l'utilisateur.

---

## WEEE Warning

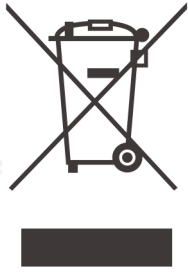

WEEE Disposal and Recycling Information All products bearing this symbol are waste electrical and electronic equipment (WEEE as in directive 2012/19/EU) which should not be mixed with unsorted household waste. Instead, you should protect human health and the environment by handing over your waste equipment to a designated collection point for the recycling of waste electrical and electronic equipment, appointed by the government or local authorities. Correct disposal and recycling will help prevent potential negative consequences to the environment and human health. Please contact the installer or local authorities for more information about the location as well as terms and conditions of such collection points.

---

## EU Declaration of Conformity

Hereby, Shenzhen Sonoff Technologies Co., Ltd. declares that the radio equipment type BASICR4 is in compliance with Directive 2014/53/EU. The full text of the EU declaration of conformity is available at the following internet address:

<https://sonoff.tech/usermanuals>

---

## EU Operating Frequency Range:

Wi-Fi: 802.11 b/g/n20 2412–2472 MHz ;

802.11 n40: 2422–2462 MHz ;

BLE: 2402–2480 MHz

---

## EU Output Power:

Wi-Fi 2.4G ≤ 20dBm ; BLE ≤ 13dBm

---

Scatola	Manuale
PAP 21	PAP 22
Carta	Carta
RACCOLTA DIFFERENZIATA	
<p>Verifica le disposizioni del tuo Comune.</p> <p>Separa le componenti e conferiscile in modo corretto.</p>	

# SONOFF

**Manufacturer: Shenzhen Sonoff Technologies Co., Ltd.**

Address: 3F & 6F, Bldg A, No. 663, Bulong Rd, Shenzhen, Guangdong, China

ZIP code: 518000

Service email: support@itead.cc

Website: sonoff.tech

Made in China

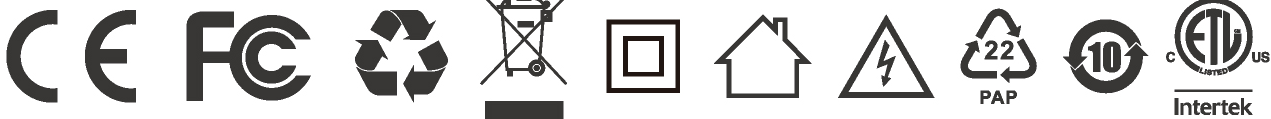

FR

Cet appareil se recycle

À DÉPOSER  
EN MAGASIN

OU

À DÉPOSER  
EN DÉCHÈTERIE

Points de collecte sur [www.quefairedemesdechets.fr](http://www.quefairedemesdechets.fr)  
Privilégiez la réparation ou le don de votre appareil !