



**HESTORE.HU**

elektronikai alkatrész áruház

**EN:** This Datasheet is presented by the manufacturer.

Please visit our website for pricing and availability at [www.hestore.hu](http://www.hestore.hu).

# SDM3055 Series

## Digital Multimeter

User Manual

EN03B



SIGLENT TECHNOLOGIES CO.,LTD



# Contents

<b>Copyright and Statement</b> .....	<b>1</b>
<b>General Safety Summary</b> .....	<b>2</b>
<b>Safety Terms and Symbols</b> .....	<b>6</b>
<b>Daily Maintenance and Cleaning</b> .....	<b>7</b>
<b>Introduction of SDM3055</b> .....	<b>8</b>
<b>Abstract</b> .....	<b>9</b>
<b>Chapter 1 Quick Start</b> .....	<b>10</b>
General Inspection .....	11
To adjust the Handle .....	12
Front Panel.....	13
Back Panel .....	14
Power On .....	15
User Interface.....	16
Scan Card .....	17
<b>Chapter 2 Function and Operation</b> .....	<b>20</b>
To Select Measurement Range .....	21
To Select Measurement Speed .....	23
Basic Measurement Functions.....	24
To Measure DC Voltage .....	25
To Measure DC Current .....	27
To Measure AC Voltage .....	29
To Measure AC Current.....	31
To Measure 2-Wire/4-Wire Resistance .....	33
To Measure Capacitance.....	37
To Measure Frequency or Period.....	39
To Test Continuity.....	43
To Test Diode .....	45
To Measure Temperature .....	47

Measurement Parameters .....	51
AC Filter .....	51
DC Input Impedance .....	51
Short-circuit Resistance .....	52
Dual-display Function.....	53
Utility Function.....	56
Store and Recall.....	56
Manage File .....	58
I/O Configuration.....	60
Board Test.....	61
Firmware Update.....	64
System Setup.....	64
Acquire .....	67
Auto Trigger .....	67
Single Trigger.....	68
External Trigger.....	69
Help System .....	70
Math Function.....	72
Statistics.....	73
Limits.....	74
dBm.....	76
dB.....	77
Relative Value .....	78
Display Mode.....	79
Trigger .....	83
Hold Measurement Function.....	84
<b>Chapter 3      Application Examples .....</b>	<b>85</b>
Example 1: Reading Statistic Functions .....	86
Example 2: To Eliminate Leads Impedance .....	87

---

Example 3: dBm Measurement .....	89
Example 4: dB Measurement .....	90
Example 5: Limits Test .....	92
Example 6: Thermocouple setting and measurement .....	94
Example 7: To Use Hold Measurement Function .....	96
Example 8: To Use Application Software EasySDM .....	97
<b>Chapter 4 Measurement Tutorial .....</b>	<b>98</b>
True RMS AC Measurement.....	98
Crest Factor Errors (non-sinusoidal inputs) .....	99
Loading Errors (AC Voltage) .....	100
Application of the Analog Filter .....	101
<b>Chapter 5 General Troubleshooting .....</b>	<b>103</b>
<b>Chapter 6 Appendix .....</b>	<b>104</b>
Appendix A: Accessories .....	104
Appendix B: Warranty summary .....	105
Appendix C: Daily Maintenance and Cleaning.....	106
Appendix D: Contact SIGLENT .....	107



## Copyright and Statement

### Copyright

**SIGLENT TECHNOLOGIES CO., LTD.** All rights reserved.

### Trademark Information

**SIGLENT** is registered trademark of **SIGLENT TECHNOLOGIES CO., LTD.**

### Statement

- **SIGLENT** products are protected by patent laws in and outside of the P.R.China.
- **SIGLENT** reserves the rights to change the specification and price.
- Information in this publication replaces all previous corresponding published material.
- Contents in this manual are not allowed to be copied, extracted or translated in any form or by any means without **SIGLENT's** permission.



## General Safety Summary

Read the following safety precautions carefully to avoid any personal injuries or damages to the instrument and any products connected to it. To avoid potential hazards, please use the instrument as specified.

### **Use proper power line.**

It's only allowed to use the special power line which is approved by local state.

### **Ground the instrument.**

The instrument is grounded through the protective terra conductor of the power line. The ground conductor must be connected to the earth to avoid electric shock. Make sure the instrument is grounded correctly before connecting its input or output terminals.

### **Connect the signal wire correctly**

The potential of the signal wire is equal to the earth, so do not connect the signal wire to a high voltage.

### **Observe all terminal ratings**

Please observe all ratings and sign instructions on the instrument to avoid fire or electric shock. Before connecting the instrument, please read the manual carefully to gain more information about the ratings.

### **Do not operate with suspected failures**

If you suspect that the product is damaged, please contact **SIGLENT's** qualified service personnel to inspect it. Any repair and adjustment to the product or replacing a component should be done by qualified personnel only.

### **Avoid circuit or wire exposure**

Don't touch exposed contacts or components when the power is on.

### **Don't operate without covers.**

Don't operate the instrument with covers or panels removed.

### **Use proper fuse.**

It's only allowed to use the specified fuse for the instrument.

### **Use proper over-voltage protection.**

Make sure there is no over-voltage (like voltage caused by thunder and lightning) reaching to the instrument, otherwise the operator may suffer an electric shock.

**Antistatic protection.**

Static electricity will cause damages to the instrument, so test in antistatic areas as far as possible. Ground its inner and outer conductors to release the static electricity temporarily before connecting the cable to the instrument.

**Keep good ventilation.**

Improper ventilation will cause the rise of the instrument's temperature. Keep good ventilation and check the vent and fan regularly when using it.

**Keep the surface of the instrument clean and dry.**

**Do not operate in wet or damp conditions.**

**Do not operate in flammable or explosive environment.**

**The disturbance test of all the models meets the limit values of A in the standard of EN 61326-1:2021.**

## Input terminal protection limitation

Protection limitation is defined for the input terminal:

1. Main input (HI and LO) terminal

HI and LO terminals are used for Voltage, Resistance, Capacitance, Continuity, Frequency and Diode measurement. Two protection limitations are defined:

- **HI-LO protection limitation:** 1000VDC or 750AVC. It's the maximum measurable voltage. The limitation can be expressed as 1000Vpk.
- **LO-ground protection limitation:** LO terminal can "float" 500Vpk relative to the ground safely. The maximum protection limitation of HI terminal relative to the ground is 1000Vpk. Therefore, the sum of the "float" voltage and the measured voltage can't exceed 1000Vpk.

2. Sampling (HI sense and LO sense) terminal

HI sense and LO sense are used for 4-wire Resistance measurement. Two protection limitations are defined:

- HI sense-LO sense protection limitation: 2000Vpk.
- LO sense-LO sense protection limitation: 2Vpk.

3. Current input (I) terminal

I and LO terminals are used for current measurement. The maximum current which go through the I terminal is limited to 10A by the fuse on the back panel.

### NOTE:

Voltage on the current input terminal corresponds to voltage on LO terminal. To keep good protection, only use the fuse of specified type and level to replace this fuse.

## IEC Measurement Category II Over-voltage Protection

SDM3055 Digital Multimeter provides over-voltage protection for line-voltage mains connections meeting both of the following conditions to avoid the danger of electric shock:

- The HI and LO input terminals are connected to the mains under Measurement Category II conditions as following.
- The maximum line voltage of the mains is 600VAC.

**WARNING:**

IEC Measurement Category II includes electrical devices connected to mains at an outlet on a branch circuit, such as most small appliances, test equipments, and other devices that plug into a branch outlet or socket.

**SDM3055** is capable of making measurements with the **HI** and **LO** inputs connected to mains in such devices (up to 600VAC) or the branch outlet itself. However, the **HI** and **LO** terminals of **SDM3055** can't be connected to mains in permanently installed electrical devices such as the main circuit-breaker panels, sub-panel disconnected boxes and permanently wired motors. Such devices and circuits are prone to exceed the protection limits of **SDM3055**.

**NOTE:**

Voltages above 600VAC only can be measured in circuits that are isolated from mains. However, there may be transient over-voltage in circuits that are isolated from mains. **SDM3055** is able to withstand occasional transient over-voltage up to 2500Vpk. Please don't use this instrument to measure circuits that transient over-voltage may exceed this level.

## Safety Terms and Symbols

Terms in this manual. Terms may appear in this manual.



**WARNING:**

Warning statements indicate the conditions and behaviors that could result in injury or loss of life.



**CAUTION:**

Caution statements indicate the conditions and behaviors that could result in damage to this product or other



**CAT I (1000V):**

IEC Measurement Category I. The highest measurable voltage is 1000Vpk in the HI-LO terminal



**CAT II (600V):**

IEC Measurement Category II. Inputs may be connected to mains (up to 600VAC) under Category II overvoltage

Terms used on the instrument. Terms may appear on the instrument:

- DANGER** Indicates an injury or hazard that may immediately happen.
- WARNING** Indicates an injury or hazard that may not immediately happen.
- CAUTION** Indicates that a potential damage to the instrument or other property might occur.

Symbols used on the instrument. Symbols may appear on the instrument.



Hazardous  
Voltage



Protective  
Earth Ground



Warning



Test  
Ground



Chassis  
Ground

## Daily Maintenance and Cleaning

### Maintenance

When storing or placing the instrument, please avoid the liquid crystal display from direct sunlight for a long time.

#### NOTE:

To avoid damages to the instrument or probe, please don't place them in mist, liquid or solvent.

### Cleaning

Please often clean the instrument or probe according to the use of them.

- Wipe the external ash of the instrument and probe by a soft rag. Be careful not to scratch the transparent plastic protective screen when cleaning the liquid crystal screen.
- Use a soft rag that has been soaked by water to clean the instrument after cutting off the power. Or use 75% isopropyl alcohol of water solvent to get a more thorough cleaning.

#### NOTE:

- To prevent the surface of the instrument or probe from damages, please don't use any corrosive or chemical cleaning reagents.
- Please make sure the instrument is already dry before restarting it to avoid short circuits or personal injuries caused by water.

## Introduction of SDM3055

**SDM3055** is a 5½ dual-display instrument, especially fitting to the needs of high-precision, multifunction, and automation measurements. It realized a combination of basic measurement functions, multiple math functions, and display functions, etc.

**SDM3055** holds a 4.3-inch color TFT-LCD display screen with 480\*272 high resolutions. Its clear keyboard layout and operation hints make it easier and agility to use. Besides, it supports multi-interface such as USB Device & Host, LAN and USB-GPIB (optional), which can meet users' demand furthest.

### Main Features:

- 4.3-inch color TFT-LCD display screen with 480\*272 high resolutions
- Real 5½ digits readings resolution
- Up to 150rdgs/S measurement speed
- True-RMS AC Voltage and AC Current measurements
- 1 Gb Nand Flash size, mass storage configuration files and data files
- Built-in cold terminal compensation for thermocouple
- Support standard SCPI and control software on PC, compatible with commands of main stream multimeters
- Supports dual-display function, Chinese and English menu
- Built-in help system, convenient to acquire information
- Support USB Device, USB Host, LAN, and USB-GPIB interfaces
- Configuration and measured data can be imported or exported via VXI 11, USBTMC and USB flash drive, which is convenient for users to modify, view and backup

## Abstract

The manual mainly introduces corresponding information of operating the **SDM3055** Digital Multimeter. It contains these chapters:

### **Chapter 1 Quick Start**

Guide you to prepare the **SDM3055** Digital Multimeter and know about the Front/Back panel and user interface.

### **Chapter 2 Function and Operation**

Introduce the functions and operations of **SDM3055** in details.

### **Chapter 3 Application Examples**

Introduce you how to use strong measurement functions of this instrument easily through some examples.

### **Chapter 4 Measurement Tutorial**

Guide you to eliminate the errors that may appear during your measurement and obtain accurate result.

### **Chapter 5 General Troubleshooting**

Provide you some general troubleshooting.

### **Chapter 6 Appendix**

Provide you information about accessories, warranties, troubleshooting, services and supports.



## Chapter 1 Quick Start

This chapter guides users to quickly get familiar with the front and rear panels, user interface and measurement connections of the multimeter.

This chapter contains the following topics:

- General Inspection
- To adjust the Handle
- Front Panel
- Back Panel
- Power On
- User Interface
- Scan Card

## General Inspection

1. Inspect the shipping container.

Please keep the damaged container or cushioning material until the contents of the shipment have been checked for completeness and the instrument has passed both electrical and mechanical tests.

Damages of the instrument caused by the shipment will be compensated by the shipper or carrier.

**SIGLENT** will not be responsible for the free repair or replacement.

2. Inspect the instrument.

If there exit any mechanical damages or lacking of components, or the instrument fails the electrical and mechanical test, please contact your **SIGLENT** sales.

3. Check the accessories.

Check the accessories according to the packing list carefully. If there exit any accessories damaged or missing, please contact your **SIGLENT** sales.

## To adjust the Handle

Adjust the handle position of **SDM3055** properly to place the instrument stably so that users can manipulate and observe the display better. Please grip the handle by the two sides and pull it outward. Then rotate the handle to the appropriate position. Please operate as the following diagram.

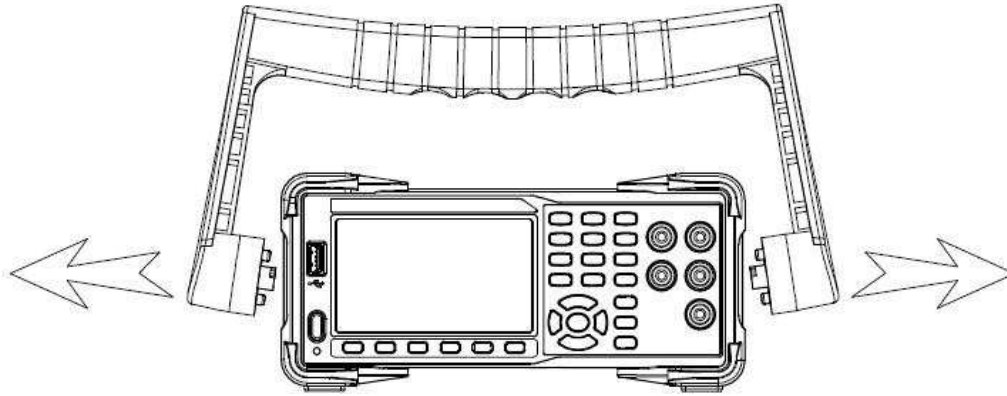

Diagram 1-1 Handle adjustment

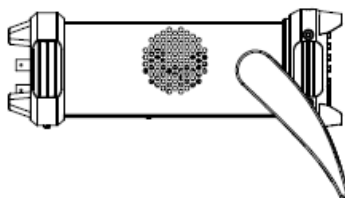
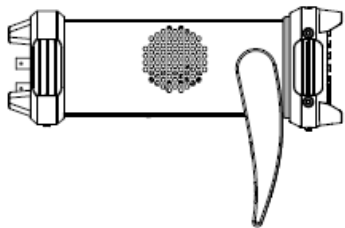
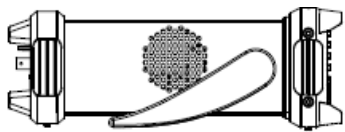

Diagram 1-2 Horizontal Position

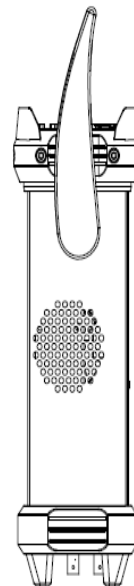

Diagram 1-3 Carrying Position

## Front Panel

SDM3055 Digital Multimeter provides users with brief and clear front panel. These control buttons are group by logic and users only need choose corresponding buttons to carry out basic operations, as shown in Diagram 1-4.



Diagram 1-4 Front Panel Overview

- |  |  |
|--|--|
| <b>A</b> LCD Display                     | <b>F</b> Auxiliary Measurement Function Keys |
| <b>B</b> USB Host                        | <b>G</b> Enable Trig Keys                    |
| <b>C</b> Power Key                       | <b>H</b> Direction Keys                      |
| <b>D</b> Menu Keys                       | <b>I</b> Signal Input Port                   |
| <b>E</b> Basic Measurement Function Keys |  |

## Back Panel

SDM3055 Digital Multimeter's Back Panel provides users with abundant interfaces, including USB Device, USB Host, LAN and GPIB (Only for SDM3055A), as shown in the following diagram.

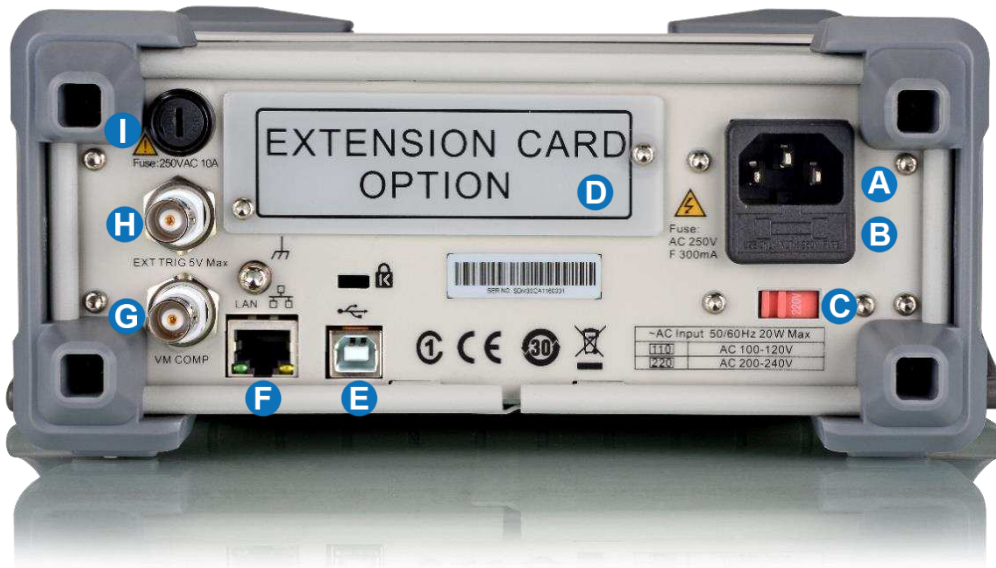

Diagram 1-5 Back Panel Overview

- |                                    |                             |
|------------------------------------|-----------------------------|
| <b>A</b> Power Socket              | <b>F</b> 10/100 Ethernet    |
| <b>B</b> Power Fuse                | <b>G</b> VMC Output         |
| <b>C</b> AC Voltage Selector       | <b>H</b> Ext Trig           |
| <b>D</b> Inspection card interface | <b>I</b> Current Input Fuse |
| <b>E</b> USB Device (USBTMC)       |                             |

## Power On

Please power on the instrument as the following steps:

1. Adjust AC Voltage Selector to 110 (100~120V, 45~440Hz, AC) or 220 (200~240V, 50/60Hz, AC) in accordance with power standards in your country;
2. Connect the instrument to AC supply via power cord supplied by **SIGLENT**;
3. The power indicator light on the front panel will glitter slowly;
4. Press the power key on the front panel, the instrument will be started a few seconds later.

## User Interface

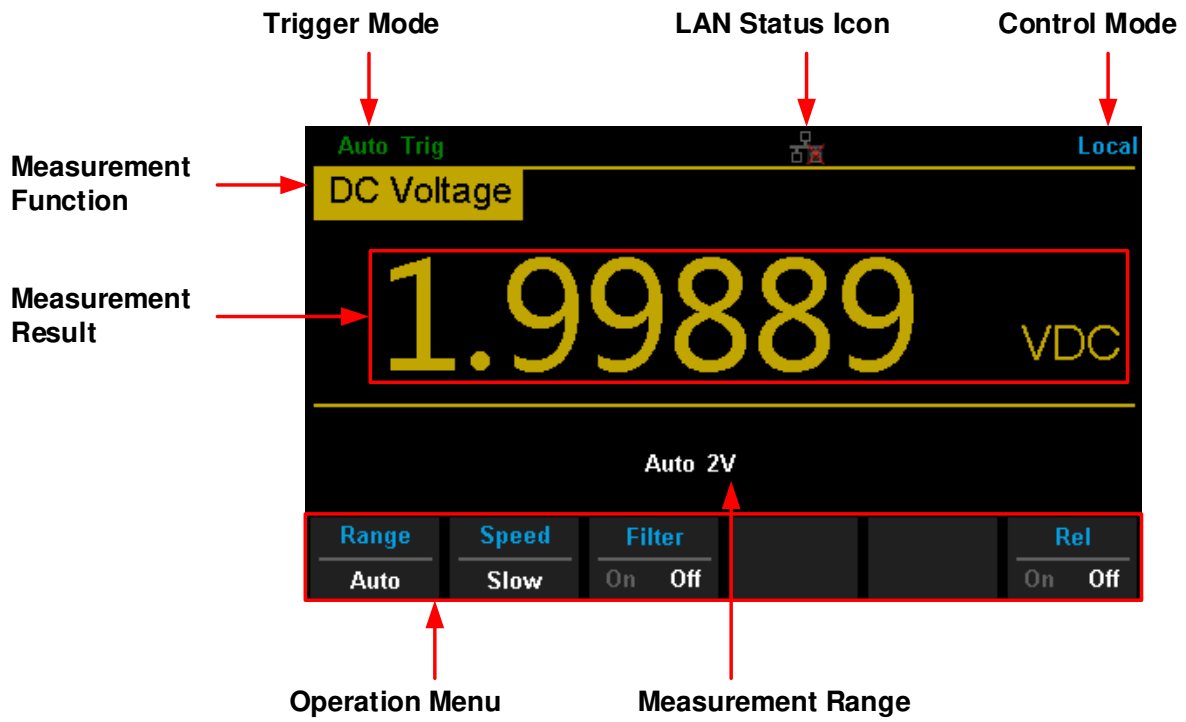

Diagram 1-6 Single Display Interface

## Scan Card

SDM3065x-sc in this multimeter supports 16 channel external patrol card and multi-point multi signal test.

Table 1-1 Scan Card SC1016 measurement and test line connection.

Items	No. of wires	Number of channels
DCV, ACV <sup>[1]</sup>	2 wires (H,L)	12 pairs (CH1~CH12) (125VAC,110VDC)
DCI, ACI <sup>[2]</sup>	2 wires (H,L)	4 pairs (CH13~CH16) (2A range only)
2-Wire R,etc. <sup>[3]</sup>	2 wires (H,L)	12 pairs (CH1~CH12)
4-Wire R	4 wires (Input H, L + Sense H,L)	6 pairs (CH1 [input] &CH9 [sense] , 2&8 , ....6&12)

### Notes:

<sup>[1]</sup> In 200V gear, the input signal is limited to 125VAC and 110VDC.

<sup>[2]</sup> Only the current below 2.2A is measured, and the error is: accuracy  $\pm 3\%$  (reading) + 0.02% (range)

<sup>[3]</sup> There are capacitance, diode, continuity, frequency/period, temperature (thermocouple), temperature 2-W RTD. The No. of wires and the Number of channels are the same with 2-W resistance.

### Operation Steps:

#### 1. Scanner Installtion

- ① Turn off the power and pull out the power cord.
- ② Unscrew the two screws and take out the cover plate of the slot.

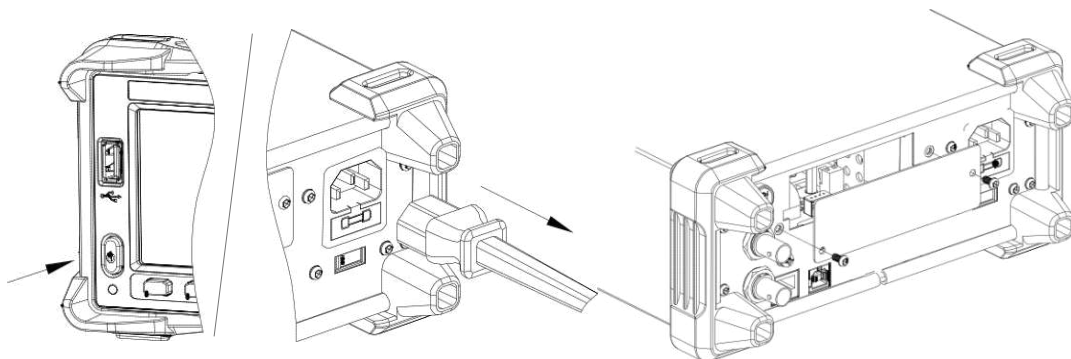

- ③ Press the connector button with your finger, and then insert the connecting line.



- ④ Lead out the connecting line from the opening of the cover plate as shown in the figure, and then fix the connecting line on the cable fixing base.

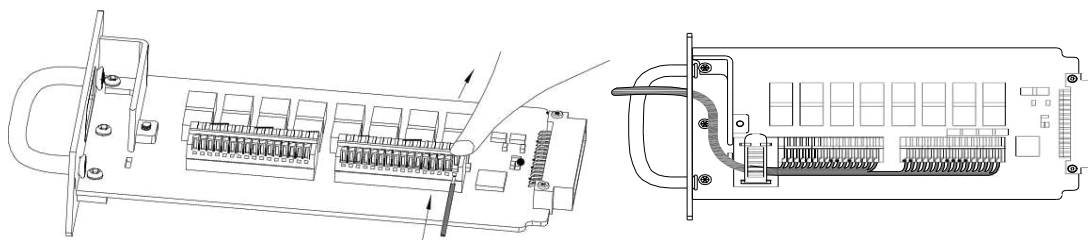

- ⑤ Insert the scan card SC1016 into the body along the guide rail, and lock the two screws again.
- ⑥ Plug in the power cord and turn it on.

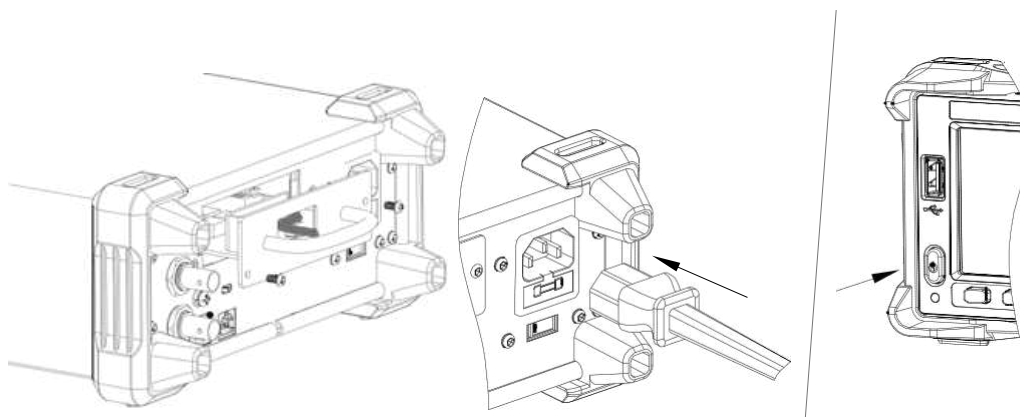

## 2. Measurement connection method

- 1) 2-wire measurement mode [1] (voltage, current, 2-W resistance, capacitance, frequency/period, continuity, diode, temperature)

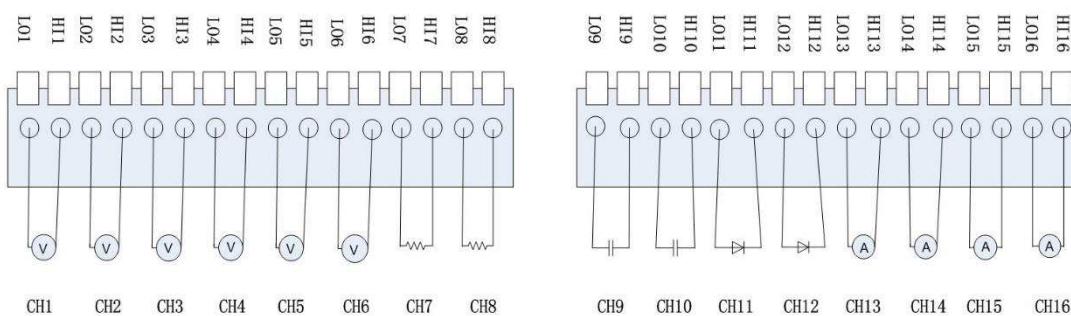

**Notes:**

[1] Each channel of CH1-CH12 can be used for switching measurement of voltage, 2-W resistance, capacitance, frequency, continuity, diode, temperature, etc. CH13-CH16 channels are fixed for current measurement below 2.2A.

## 2) 4-wire measurement mode

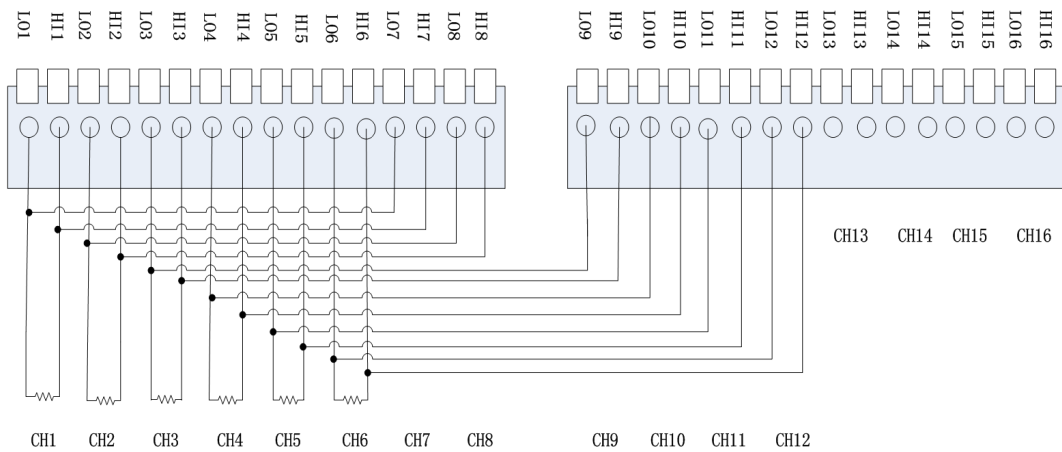

## Chapter 2      Function and Operation

- To Measure DC Voltage / Current
- To Measure AC Voltage / Current
- To Measure 2-Wire / 4-Wire Resistance
- To Measure Frequency / Capacitance
- To Test Continuity / Diode
- To Measure Temperature / Optional Multiple Scan Card
- To use Dual-display Function or Set Up the Utility
- Acquire Function or Help System
- Math Function or Display Function
- Run / Stop
- Single Trigger / Hold Measurement Function
- To Switch Functions or Return to Local Menu
- To Select Measurement Range

## To Select Measurement Range

The Multimeter has two kinds of modes of selecting measurement range: “Auto” and “Manual”. It can select appropriate range according to the signals input in Auto mode, which is very convenient for users. While in Manual mode, you can obtain higher reading precision. Range selection keys are on the right side of the front panel as the following diagram.

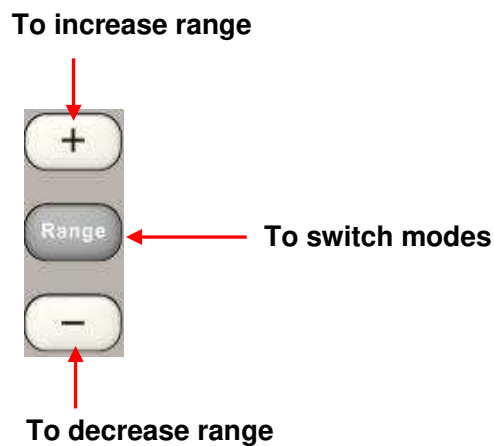

Diagram 2-1 Range Selection Keys

### Method 1: By Function keys on the Front Panel

Auto Range: Press **Range** to switch between Auto Range and Manual Range.

Manual Range: Press **+** to increase range and press **-** to decrease range.

### Method 2: By softkeys on the measurement main interface as Diagram 2-2.

Auto Range: Press [Auto] to choose Auto Range, meanwhile Manual Range is forbidden.

Manual Range: Press [200mV] , [2V] , [20V] , [200V] or [1000V] to choose required range manually.

Auto Range is forbidden at this moment.

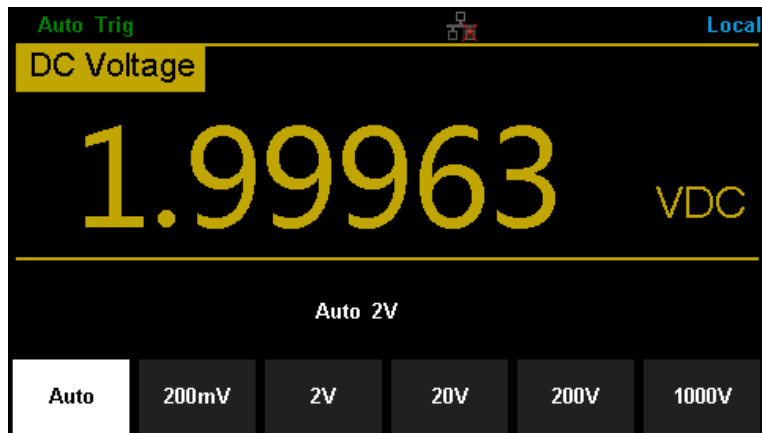

Diagram 2-2 Range selection menus

**Explanations:**

1. When the input signal is beyond the current scope of the measurement range, the Multimeter will show “overload”.
2. Range option will turn back to default setting “Auto” after restarting and remote reset.
3. Users are suggested to select “Auto” range so as to protect the instrument against damage and get exact data as much as possible when it’s hard to predict the range of measurement.
4. For Dual-display Function, the measurement ranges of Main display and vice display are similar and can’t be changed independently
5. The range is fixed during testing the Continuity and Diode. The range of continuity is selected as 2k $\Omega$ , while the Diode is 2V.
6. Auto Range is not suitable for measuring current up to 10A. If the signal is used to I Terminal, users need to choose range manually.

## To Select Measurement Speed

The instrument provides three types of measurement rate: 5 reading/s, 50 reading/s and 150 reading/s. 5 reading/s belongs to “Slow” rate; 50 reading/s belongs to “Middle” rate; 150 reading/s belongs to “Fast” rate.

Measurement speed can be controlled by softkey menu. Press [Speed] and then press [Slow], [Middle] or [Fast] to choose measurement speed.

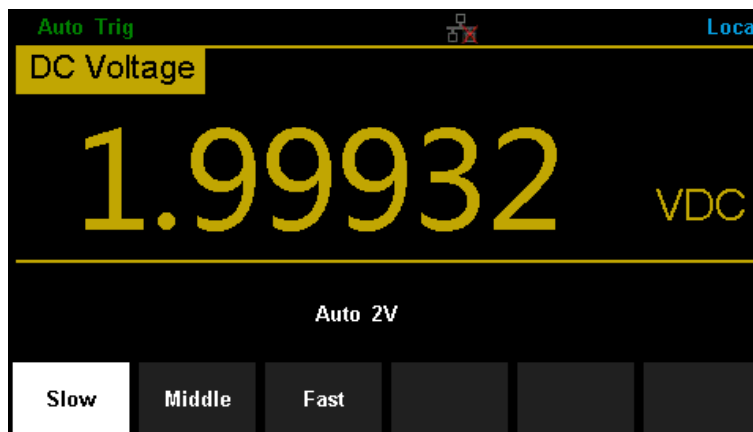

Diagram 2-3 Range selection menu

### Explanations:

1. Three reading rates are available for DCV, ACV, DCI, ACI and 2-Wire/4-Wire Resistance: “Slow”, “Middle” and “Fast”.
2. There is a linkage for both reading resolution and reading (measurement) rate.
3. 5 reading/s belongs to 5.5 digit resolution.
4. Both 20 reading/s and 123 reading/s belong to 4.5 digit resolution.
5. The reading resolution of Temperature is fixed at 5.5 digit and “Slow” respectively.
6. The reading resolutions and measurement rates of both Diode and Continuity are fixed at 4.5 digit and “Fast” respectively.
7. The reading resolution and measurement rate of the Frequency function are fixed 5.5 digit and “Slow” respectively.
8. The reading resolution and measurement rate of the Capacitance function are fixed at 5.5 digit and “Slow” respectively.

## Basic Measurement Functions

SDM3055 Digital Multimeters have following basic functions:

- To Measure DC Voltage
- To Measure DC Current
- To Measure AC Voltage
- To Measure AC Current
- To Measure 2-Wire/4-Wire Resistance
- To Measure Capacitance
- To Measure Frequency or Period
- To Test Continuity
- To Test Diode
- To Measure Temperature

## To Measure DC Voltage

The Multimeter enables to measure DC Voltage up to 1000V. The method to connect and measure DC Voltage will be introduced in details as the following steps.

**(NOTE:** DC Voltage is always the selected function when the Multimeter is turned on)

Operating Steps:

1. Press **DCV** on the front panel to enter the DC Voltage measurement interface, as shown in Diagram 2- 4.

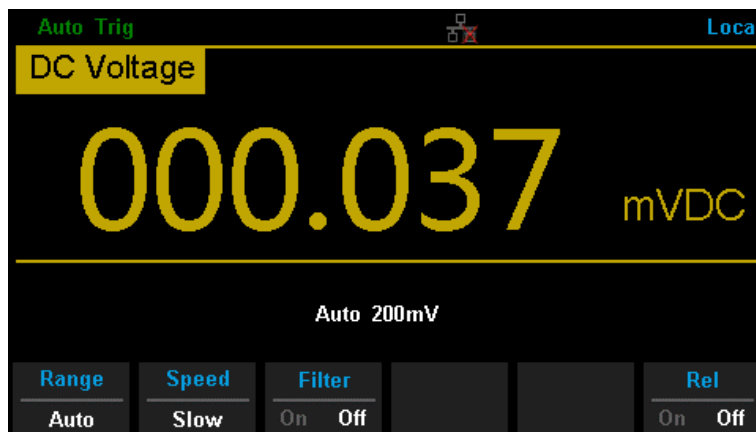

Diagram 2-4 DC Voltage Measurement Interface

2. Connect the red lead to terminal Input-HI and black lead to terminal Input-LO as the following diagram.

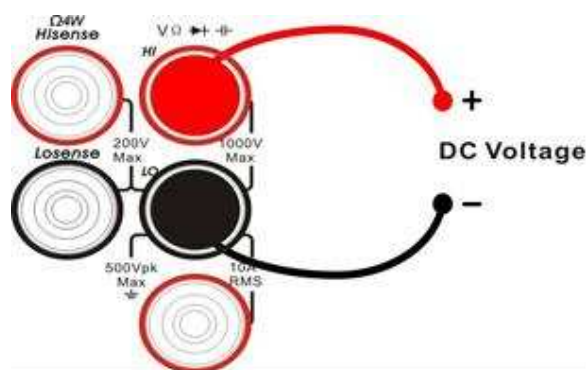

Diagram 2-5 Sketch Map for Measuring DC Voltage

3. Choose a proper voltage range according to the measured circuit.



Table 2-1 Measurement Characteristics of DC Voltage

<b>Ranges*</b>	200mV , 2V , 20V , 200V , 1000V
<b>Input Protection</b>	1000V on all ranges (HI terminal)
<b>Configurable</b>	Range, DC input impedance, Rel

**NOTE\*:**

- All the ranges enable to obtain 20% value higher than original except 1000V. Besides, both Manual and Auto are available for setting every range.
  - When inputting range is higher than 1000V at 1000V Level, “overload” will be shown on the screen.
  - 1000V input protection exists in every range.
4. Set the DC input impedance (Only for Manual 200mV and 2V ranges).  
Press [Input Z] to set the DC resistance as “10M” (default value) or “>10G”. Users can execute DC voltage measurement directly without modifying this parameter which has been setup before leaving factory.
  5. Set AC Filter function.  
Press [Filter] to open or close the AC Filter.  
(**NOTE:** Only DC Voltage and DC Current have this function.)
  6. Set relative value (Optional operation).  
Press [Rel] to open or close Relative math function. When it is opened, the reading displayed is a relative value which comes from the result of actual measurement value subtracts the value that has been set. (Please refer to “Math Functions” in Chapter 2 to know about the details.)
  7. Read measurement result.  
Select required measurement rate (reading rate) by pressing [Speed] and read the measurement result.
  8. View history data.  
There are four types of way to view historical data: “Number”, “Bar Meter” “Trend Chart” and “Histogram”.

## To Measure DC Current

The Multimeter enables to measure DC Current up to 10A. The method to connect and measure DC Current will be introduced in details as the following steps.

Operating Steps:

1. Press **Shift** and **DCV** on the front panel to enter the DC Current measurement interface, as shown in Diagram 2- 6.

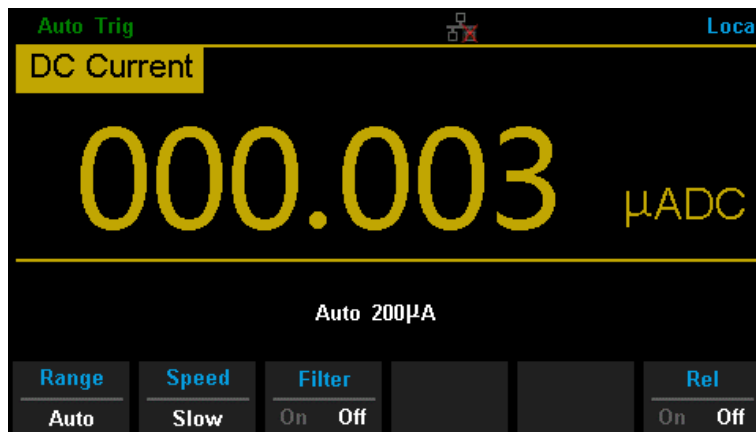

Diagram 2-6 DC Current Measurement Interface

2. Connect the red lead to terminal Input-I and black lead to terminal Input-LO as the following diagram.

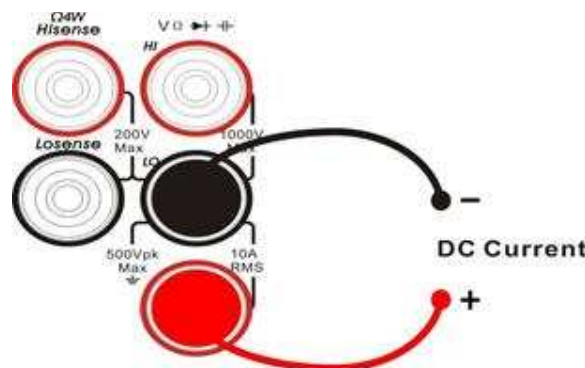

Diagram 2-7 Sketch Map for Measuring DC Current

3. Choose a proper current range according to the measured circuit.

Table 2-2 Measurement Characteristics of DC Current

<b>Ranges*</b>	200 $\mu$ A , 2mA , 20mA , 200mA , 2A , 10A
<b>Input Protection</b>	10A(back panel), 12A(inside the instrument)
<b>Configurable</b>	Range, Rel

**NOTE\*:**

All the ranges enable to obtain 20% value higher than original except 10A. Besides, both Manual and Auto are available for setting every range.

## 4. Set AC Filter function.

Press [Filter] to open or close the AC Filter.

## 5. Set relative value (Optional operation).

Press [Rel] to open or close Relative math function. When it is opened, the reading displayed is a relative value which comes from the result of actual measurement value subtracts the value that has been set. (Please refer to “Math Functions” in Chapter 2 to know about the details.)

## 6. Read measurement result.

Select required measurement rate (reading rate) by pressing [Speed] and read the measurement result.

## 7. View history data.

There are four types of way to view historical data: “Number”, “Bar Meter” “Trend Chart” and “Histogram”.

## To Measure AC Voltage

The Multimeter enables to measure AC Voltage up to 750V. The method to connect and measure DC Voltage will be introduced in details as the following steps.

Operating Steps:

1. Press **ACV** on the front panel to enter the AC Voltage measurement interface, as shown in Diagram 2- 8.

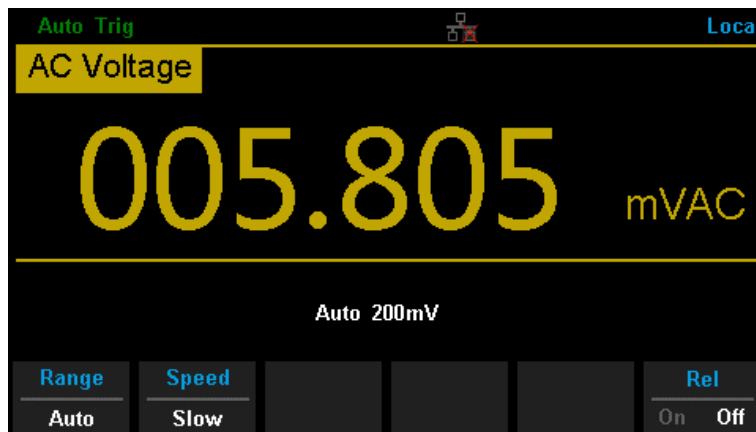

Diagram 2-8 AC Voltage Measurement Interface

2. Connect the red lead to terminal Input-HI and black lead to terminal Input-LO as the following diagram.

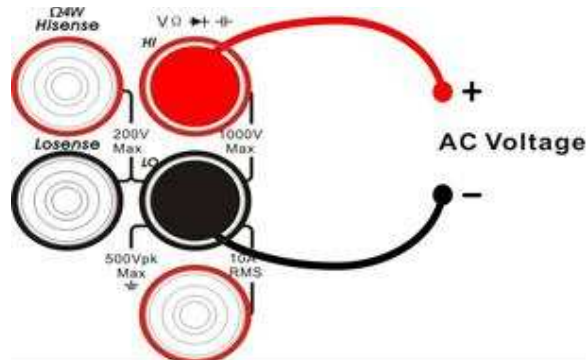

Diagram 2-9 Sketch Map for Measuring AC Voltage

3. Choose a proper voltage range according to the measured circuit.

Table 2-3 Measurement Characteristics of AC Voltage

<b>Ranges*</b>	200mV , 2V , 20V , 200V ,750V
<b>Input Protection</b>	750Vrms on all ranges (HI terminal)
<b>Configurable</b>	Range, Rel

**NOTE\*:**

- All the ranges enable to obtain 20% value higher than original except 750V. Besides, both Manual and Auto are available for setting every range.
- When inputting range is higher than 750V at 750V Level, “overload” will be shown on the screen. 750V input protection exists in every range.

## 4. Set relative value (Optional operation).

Press [Rel] to open or close Relative math function. When it is opened, the reading displayed is a relative value which comes from the result of actual measurement value subtracts the value that has been set. (Please refer to “Math Functions” in Chapter 2 to know about the details.)

## 5. Read measurement result.

Select required measurement rate (reading rate) by pressing [Speed] and read the measurement result. If you press **Dual** and then press **Shift** and **+** to get the frequency value measured from input AC signal.

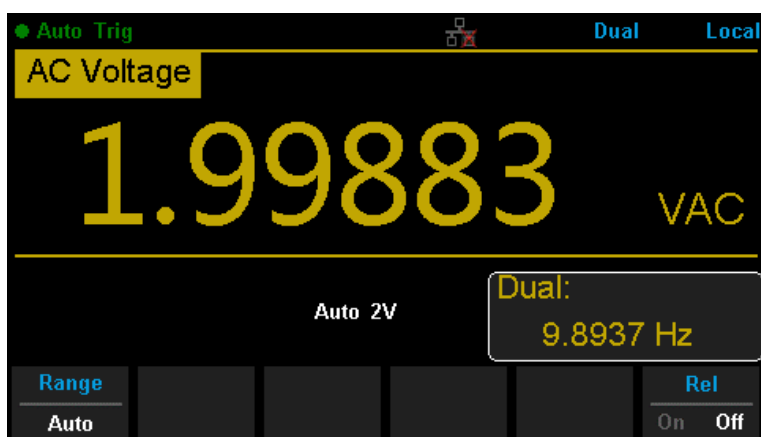

Diagram 2-10 Dual-display

## 6. View history data.

There are four types of way to view historical data: “Number”, “Bar Meter” “Trend Chart” and “Histogram”.

## To Measure AC Current

The Multimeter enables to measure AC Current up to 10A. The method to connect and measure AC Current will be introduced in details as the following steps.

Operating Steps:

1. Press **Shift** and **ACV** on the front panel to enter the AC Current measurement interface, as shown in Diagram 2-11.

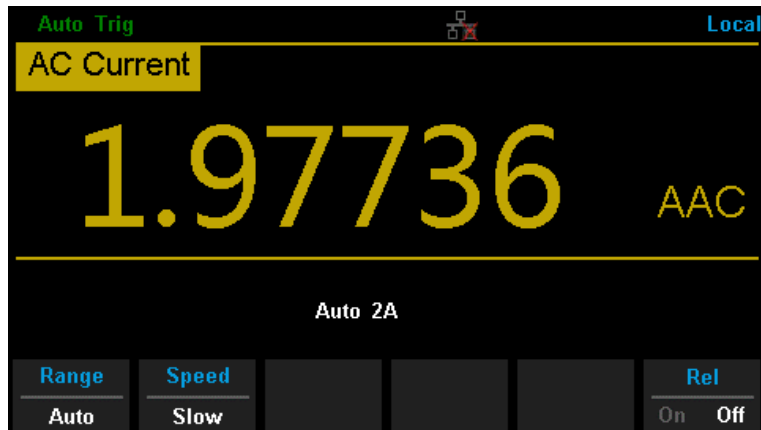

Diagram 2-11 AC Voltage Measurement Interface

2. Connect the red lead to terminal Input-I and black lead to terminal Input-LO as the following diagram.

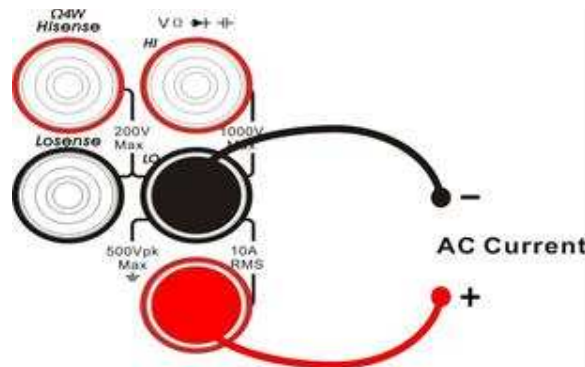

Diagram 2-12 Sketch Map for Measuring AC Current

3. Choose a proper current range according to the measured circuit.

Table 2-4 Measurement Characteristics of AC Current

<b>Ranges*</b>	200 $\mu$ A , 2mA , 20mA , 200mA , 2A , 10A
<b>Input Protection</b>	10A(back panel), 250V(fuse), 12A(inside the instrument)
<b>Configurable</b>	Range, Rel

**NOTE\*:**

All the ranges enable to obtain 20% value higher than original except 10A. Besides, both Manual and Auto are available for setting every range.

4. Set relative value (Optional operation).  
Press [Rel] to open or close Relative math function. When it is opened, the reading displayed is a relative value which comes from the result of actual measurement value subtracts the value that has been set. (Please refer to “Math Functions” in Chapter 2 to know about the details.)
5. Read measurement result.  
Select required measurement rate (reading rate) by pressing [Speed] and read the measurement result.
6. View history data.  
There are four types of way to view historical data: “Number”, “Bar Meter” “Trend Chart” and “Histogram”.

## To Measure 2-Wire/4-Wire Resistance

The Multimeter enables to measure 2-Wire Resistance and 4-Wire Resistance. The method to connect and measure 2-Wire/4-Wire Resistance will be introduced in details separately.

### 2-Wire Resistance

Operating Steps:

1. Press  $\Omega 2W$  on the front panel to enter the 2-Wire Resistance measurement interface, as shown in Diagram 2- 13.

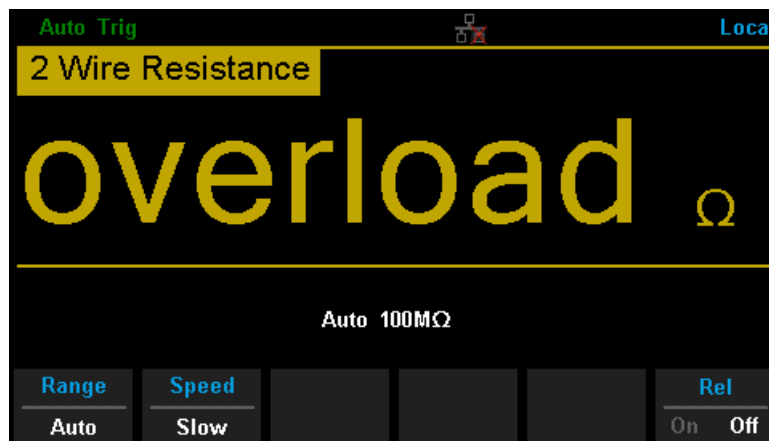

Diagram 2-13 2-Wire Resistance Measurement Interface

2. Connect the red lead to terminal Input-HI and black lead to terminal Input-LO as the following diagram.

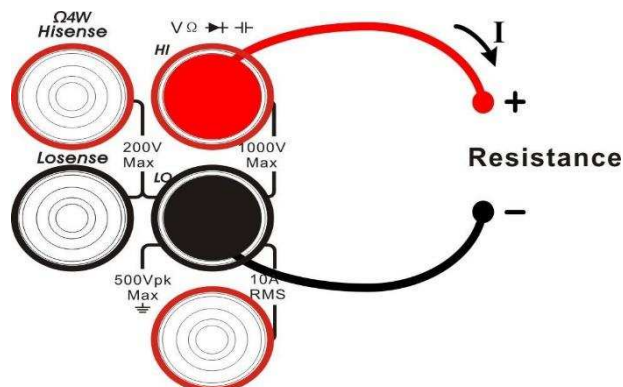

Diagram 2-14 Sketch Map for Measuring 2-Wire Resistance



- Choose a proper resistance range according to the scope.

Table 2-5 Measurement Characteristics of 2-Wire Resistance

<b>Ranges*</b>	200 $\mu$ A , 2mA , 20mA , 200mA , 2A , 10A
<b>Open-circuit Voltage</b>	<8V
<b>Input Protection</b>	1000V on every range (HI terminal)
<b>Configurable</b>	Range, Rel

**NOTE\*:**

All the ranges enable to obtain 20% value higher than original. Besides, both Manual and Auto are available for setting every range.

- Set relative value (Optional operation).  
Press [Rel] to open or close Relative math function. When it is opened, the reading displayed is a relative value which comes from the result of actual measurement value subtracts the value that has been set. (Please refer to “Math Functions” in Chapter 2 to know about the details.)
- Read measurement result.  
Select required measurement rate (reading rate) by pressing [Speed] and read the measurement result.
- View history data.  
There are four types of way to view historical data: “Number”, “Bar Meter” “Trend Chart” and “Histogram”.

**NOTE:**

You are suggested to make use of Relative function when measuring small resistance to reduce or escape impedance error from Test leads.

## 4-Wire Resistance

Operating Steps:

1. Press **Shift** and  **$\Omega$ W** on the front panel to enter the 4-Wire Resistance measurement interface, as shown in Diagram 2- 14.



Diagram 2-15 4-Wire Resistance Measurement Interface

2. Connect the red lead to terminal Input-HI and black lead to terminal Input-LO as the following diagram.

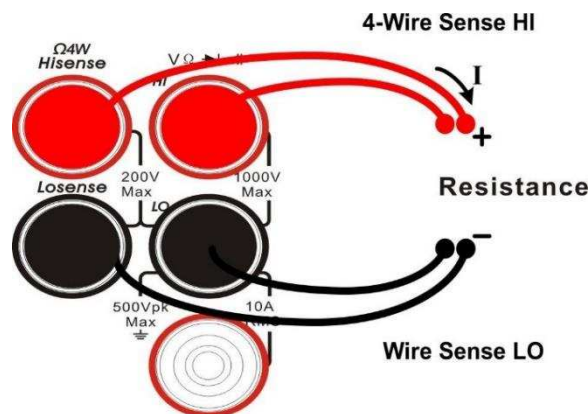

Diagram 2-16 Sketch Map for Measuring 4-Wire Resistance

3. Choose a proper resistance range according to the scope.

Table 2-6 Measurement Characteristics of 4-Wire Resistance

<b>Ranges*</b>	200Ω , 2kΩ , 20kΩ , 200kΩ , 2MΩ , 10MΩ , 100MΩ
<b>Open-circuit Voltage</b>	<8V
<b>Input Protection</b>	(1) 1000V on each range (HI terminal) (2) 200V on each range (HI Sense, LO Sense)
<b>Configurable Parameters</b>	Range, Rel

**NOTE\*:**

All the ranges enable to obtain 20% value higher than original. Besides, both Manual and Auto are available for setting every range.

4. Set relative value (Optional operation).  
Press [Rel] to open or close Relative math function. When it is open, the reading displayed is a relative value which comes from the result of actual measurement value subtracts the value that has been set. (Please refer to “Math Functions” in Chapter 2 to know about the details.)
5. Read measurement result.  
Select required measurement rate (reading rate) by pressing [Speed] and read the measurement result.
6. View history data.  
There are four types of way to view historical data: “Number”, “Bar Meter” “Trend Chart” and “Histogram”.

**NOTE:**

Please do not put the terminals of the resistance on the conductive plane or in your hand to avoid error. The bigger of the resistance, the more affection it will be brought.

## To Measure Capacitance

The Multimeter enables to measure Capacitance up to 1000 $\mu$ F. The method to connect and measure Capacitance will be introduced in details as the following steps.

### Operating Steps:

1. Press  on the front panel to enter the Capacitance measurement interface, as shown in Diagram 2- 17.

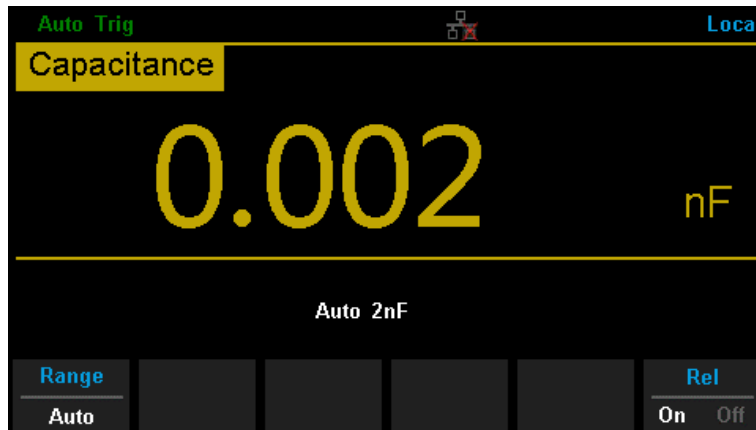

Diagram 2-17 Capacitance Measurement Interface

2. Connect the red lead to terminal Input-HI and black lead to terminal Input-LO as the following diagram.

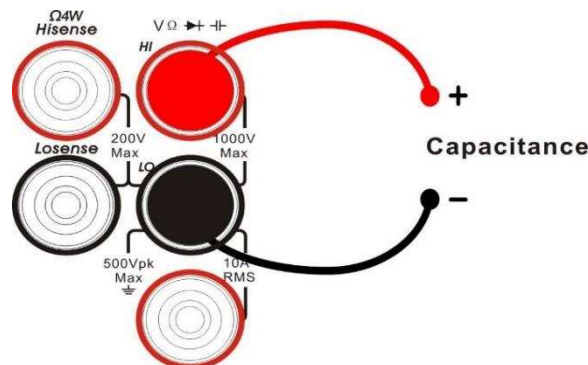

Diagram 2-18 Sketch Map for Measuring Capacitance

3. Choose a proper capacitance range according to the measured circuit.

Table 2-7 Measurement Characteristics of Capacitance

<b>Ranges*</b>	2nF , 20nF , 200nF , 2 $\mu$ F , 200 $\mu$ F , 200 $\mu$ F , 10000 $\mu$ F
<b>Input Protection</b>	1000V on all ranges (HI terminal)
<b>Configurable Parameters</b>	Range, Rel

**NOTE\*:**

All the ranges enable to obtain 20% value higher than original. Besides, both Manual and Auto are available for setting every range.

## 4. Set relative value (Optional operation).

Press [Rel] to open or close Relative math function. When it is opened, the reading displayed is a relative value which comes from the result of actual measurement value subtracts the value that has been set. (Please refer to “Math Functions” in Chapter 2 to know about the details.)

## 5. Read measurement result.

Capacitance measurement is fixed at “Slow” rate. Therefore, you can’t adjust the reading rate when reading the result.

## 6. View history data.

There are four types of way to view historical data: “Number”, “Bar Meter” “Trend Chart” and “Histogram”.

**NOTE:**

Before measuring the electrolytic capacitance, you should make the two legs of the electrolytic capacitance short circuit and let it be discharged.

## To Measure Frequency or Period

The Frequency or Period of a signal could be obtained by Dual-display Function during measuring its voltage or current or by the function button on the front panel. The method to connect and measure Frequency or Period will be introduced in details as the following steps.

### To Measure Frequency

Operating Steps:

1. Press **Shift** and **F<sub>Hz</sub>** on the front panel to enter the Frequency measurement interface. The lower right corner of the screen shows the unit of Frequency, as shown in Diagram 2- 19.

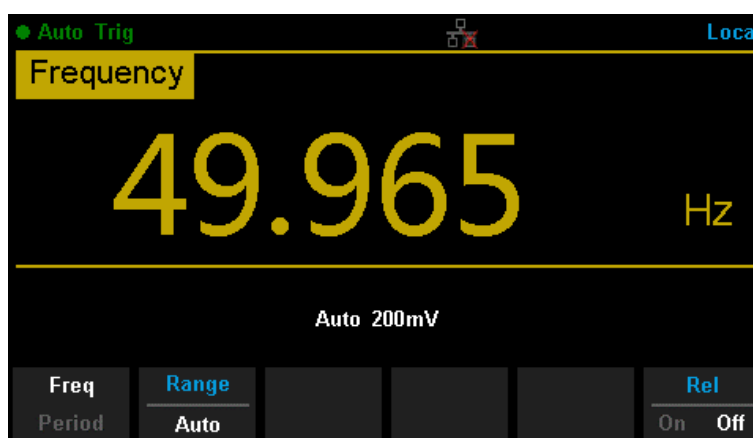

Diagram 2-19 Frequency Measurement Interface

2. Connect the red lead to terminal Input-HI and black lead to terminal Input-LO as the following diagram.

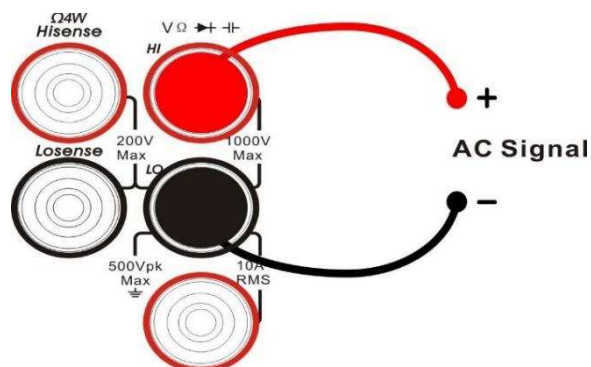

Diagram 2-20 Sketch Map for Measuring Frequency

3. Choose a proper voltage range according to the measured circuit.

Table 2-8 Measurement Characteristics of Frequency

<b>Ranges</b>	200mV, 2V, 20V, 200V, 750V
<b>Measurement Range</b>	20Hz ~ 1MHz
<b>Input Protection</b>	750Vrms on all ranges (HI terminal)
<b>Configurable</b>	Rel

4. Set relative value (Optional operation).

Press [Rel] to open or close Relative math function. When it is opened, the reading displayed is a relative value which comes from the result of actual measurement value subtracts the value that has been set. (Please refer to “Math Functions” in Chapter 2 to know about the details.)

5. Read measurement result.

Frequency measurement is fixed at “Slow” rate. Therefore, you can’t adjust the reading rate while reading the result.

6. View history data.

There are four types of way to view historical data: “Number”, “Bar Meter” “Trend Chart” and “Histogram”.

## To Measure Period

Operating Steps:

1. Press **Shift** and **Hz** on the front panel and select [Period] to enter the Period measurement interface. The lower right corner of the screen shows the unit of Period, as shown in Diagram 2-21.

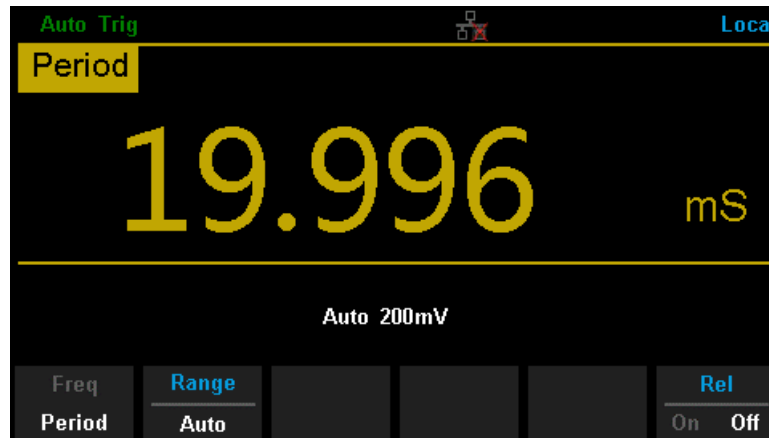

Diagram 2-21 Period Measurement Interface

2. Connect the red lead to terminal Input-HI and black lead to terminal Input-LO as the following diagram.

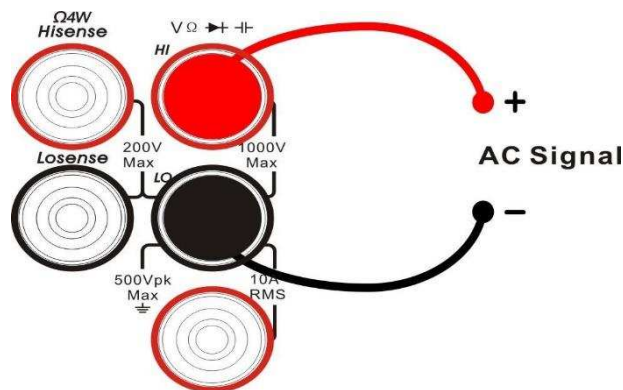

Diagram 2-22 Sketch Map for Measuring Period

3. Choose a proper voltage range according to the measured circuit.



Table 2-9 Measurement Characteristics of Period

<b>Ranges</b>	200mV, 2V, 20V, 200V, 750V
<b>Measurement Range</b>	20Hz ~ 1MHz
<b>Input Protection</b>	750Vrms on all ranges (HI terminal)
<b>Configurable</b>	Rel

4. Set relative value (Optional operation).

Press [Rel] to open or close Relative math function. When it is open, the reading displayed is a relative value which comes from the result of actual measurement value subtracts the value that has been set. (Please refer to “Math Functions” in Chapter 2 to know about the details.)

5. Read measurement result.

Period measurement is fixed at “Slow” rate. Therefore, you can’t adjust the reading rate while reading the result.

6. View history data.

There are four types of way to view historical data: “Number”, “Bar Meter” “Trend Chart” and “Histogram”.

## To Test Continuity

Continuity test uses double leads method to measure the resistance of the measured circuit via about 0.5mA current. When the measured resistance in circuit is lower than the selected one, it is considered being connected with instrument. The method to test Continuity will be introduced in details as the following steps.

Operating Steps:

1. Press **Cont** on the front panel to enter the Continuity test interface, as shown in Diagram 2- 23.

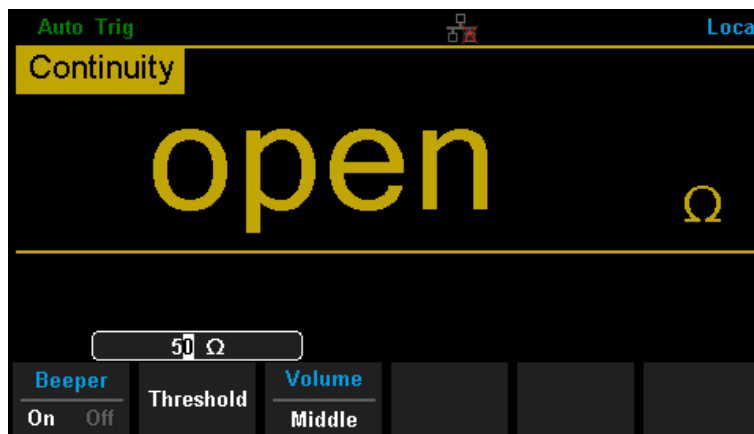

Diagram 2-23 Continuity Measurement Interface

2. Connect the red lead to terminal Input-HI and black lead to terminal Input-LO as the following diagram.

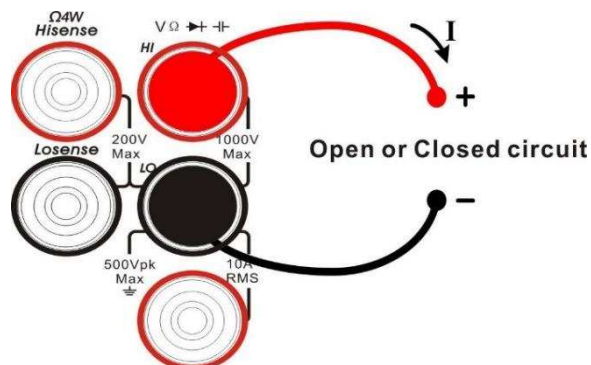

Diagram 2-24 Sketch Map for Testing Continuity

3. Set the Short-circuit resistance.

The default value is set as 50Ω before leaving factory. The value can be changed by using direction keys. You also can execute the Continuity measurement directly without modification.

Table 2-10 Measurement Characteristics of Continuity

<b>Test Current</b>	1mA
<b>Ranges*</b>	Fixed at 2kΩ
<b>Open-circuit Voltage</b>	<8V
<b>Input Protection</b>	1000V on all ranges (HI terminal)
<b>Beep Condition</b>	$0 \leq R_{\text{testing}} \leq \text{Short-circuit impedance}$ $1\Omega \leq \text{Short-circuit impedance} \leq 2\text{k}\Omega$

4. Set the Beeper function.

Press [Beeper] to turn on or off the Beeper. If the circuit is continuous, the instrument will beep once when the Beeper is turned on.

5. Search for the test point and read measurement result.

**NOTE:**

Before testing continuity, please cut off the power and discharge all the high-voltage containers to avoid damages to the Multimeter.

## To Test Diode

If input voltage is under +0.7V (about 1.4k $\Omega$ ), the Beeper will beep one time. If input voltage is under 50mV (about 100 $\Omega$ ) the Beeper will beep persistently. The method to test Diode will be introduced in details as the following steps.

Operating Steps:

1. Press **Shift** and **Cont** on the front panel to enter the Diode test interface, as shown in Diagram 2- 25.

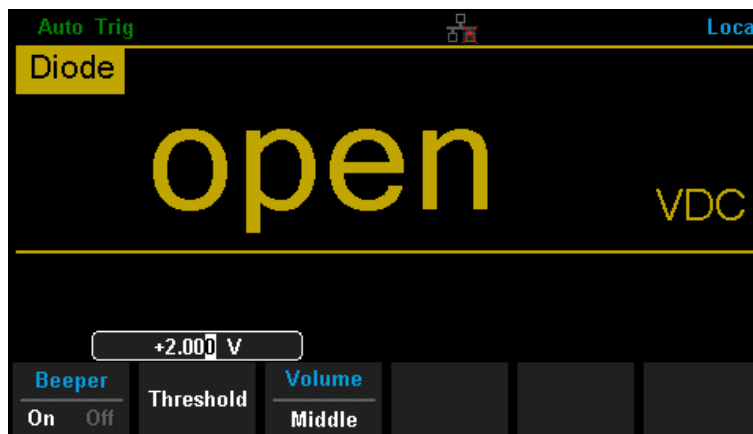

Diagram 2-25 Diode Test Interface

2. Connect red lead to both terminal Input-HI and anode of the Diode and black lead to both terminal Input-LO and cathode of the Diode as the following diagram.

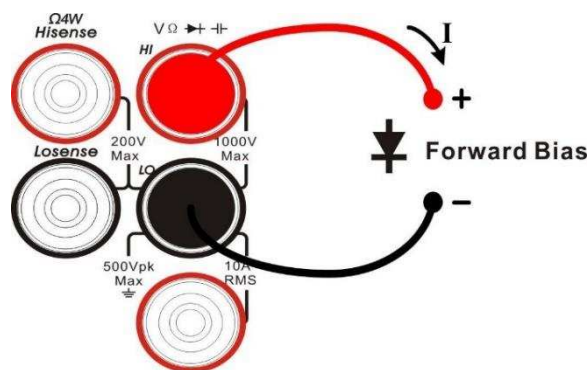

Diagram 2-26 Sketch Map for testing Diode

3. Set the Beeper function.  
Press [Beeper] to turn on or off the Beeper. If the circuit is continuous, the instrument will beep once when the Beeper is turned on.

Table 2-11 Characteristics of Checking Diodes

<b>Test Current</b>	1mA
<b>Ranges*</b>	Fixed at 2V
<b>Open-circuit Voltage</b>	<8V
<b>Input Protection</b>	1000V (HI terminal)
<b>Beep Condition</b>	$0.1V \leq V_{\text{measured}} \leq 2.0V$

4. Read measurement result.
5. Reverse the probes and measure the voltage in the diode once more. Evaluate the diode according to the following rules:
  - If the Multimeter shows “overload” when in reverse bias model, it indicates that the diode is normal.
  - If the Multimeter shows voltage about 0V and the instrument beeps persistently when in forward and reverse bias model, it indicates that the diode is short.
  - If the Multimeter shows “overload” when in forward and reverse model, it indicates that the diode is open.

**NOTE:**

Before testing diode, please cut off the power and discharge all the high-voltage containers to avoid damages to the Multimeter.

## To Measure Temperature

The Multimeter supports for two types of temperature sensor: TC and RTD. The method to connect and measure Temperature will be introduced in details as the following steps.

Operating Steps:

1. Press **Temp** on the front panel to enter the Temperature measurement interface, as shown in Diagram 2- 27.

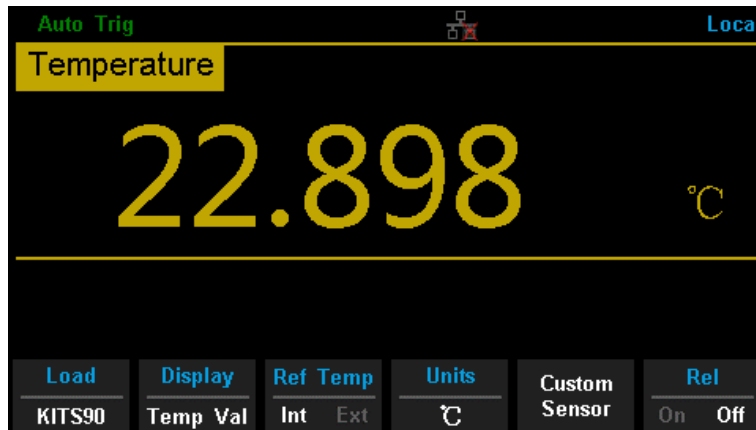

Diagram 2-27 Temperature Measurement Interface

2. Connect the red lead to terminal Input-HI and black lead to terminal Input-LO as the following diagram.

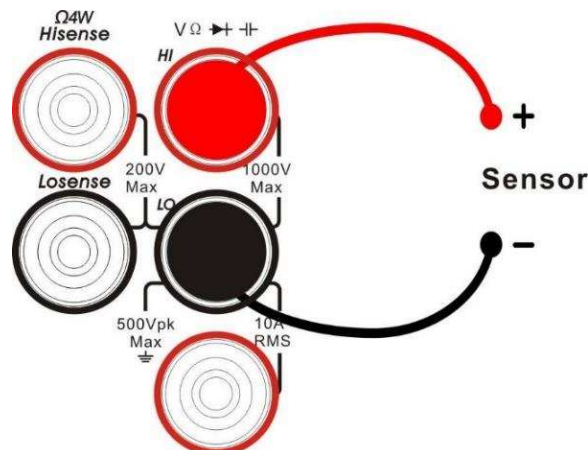

Diagram 2-28 Sketch Map for Measuring Temperature

3. Press [Load] and use direction keys to select the required file. Then press [Read] to recall an existing configuration file.

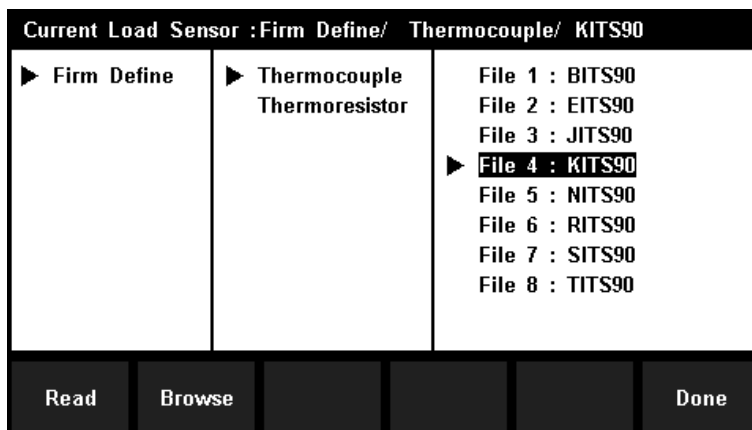

Diagram 2-29 Load a Configuration File

- Press [Browse] to view the configuration, as shown in the following diagram:

No	Measure Value	Temperature
1	-6.45800	-270.000
2	-6.44100	-260.000
3	-6.40400	-250.000
4	-6.34400	-240.000
5	-6.26200	-230.000
6	-6.15800	-220.000
7	-6.03500	-210.000

Diagram 2-30 Configuration of the Sensor

- Press [Display] to choose a display mode. The Multimeter supports three display modes: Temperature Value, Measured Value and All.

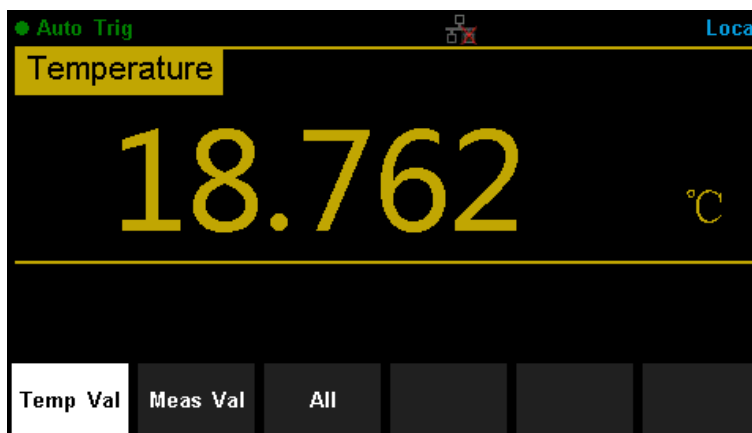

Diagram 2-31 Choose Display Mode of Temperature Measurement

Press [All], the measured value will be shown on the Vice display and the corresponding value will be shown on the Main display at the same time, which is convenient for users to observe temperature and voltage values.

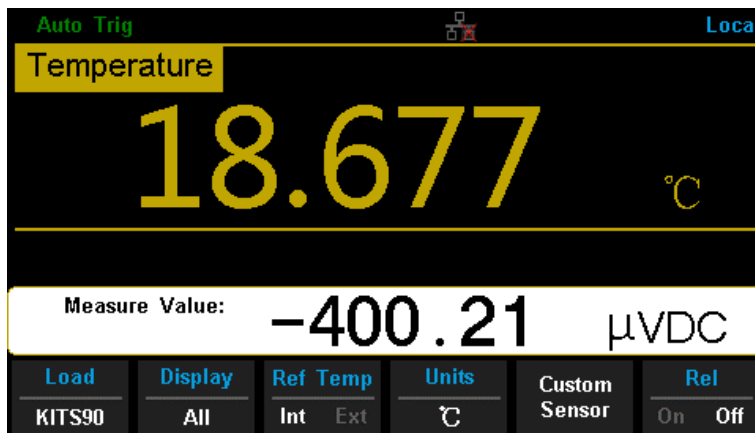

Diagram 2-32 Show Temperature And Voltage Values

6. Press [Units] to choose the unit of temperature. The Multimeter supports three units: °C, °F, K.

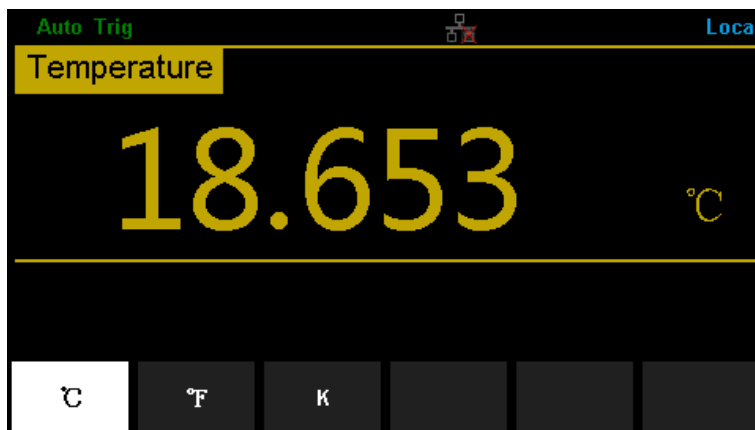

Diagram 2-33 Unit Selection Interface

7. Choose Cold Junction Compensation program (Optional operation).  
Press [Ref Temp] to select inter Cold Junction Compensation or external Cold Junction Compensation. Inter Cold Junction Compensation is default configuration, external Cold Junction Compensation need user set calibration equipment temperature during calibration.



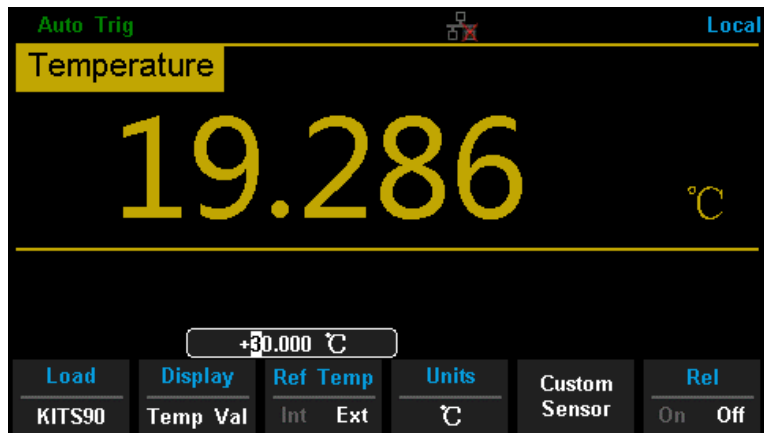

Diagram 2-34 Set external Cold Junction Compensation

8. Set relative value (Optional operation).

Press [Rel] to open or close Relative math function. When it is opened, the reading displayed is a relative value which comes from the result of actual measurement value subtracts the value that has been set.

(Please refer to “Math Functions” in Chapter 2 to know about the details.)

## Measurement Parameters

The parameters have been configured before the Multimeter leaving factory. Users can either measure directly or modify them to meet your own requirements.

### AC Filter

AC Filter is applicable for DC Voltage and DC Current measurement. When DC Voltage or DC Current function is selected, press [Filter] to open the filter, as shown in the following diagram. If AC component existing in inputted DC signal, it can be filtered by AC Filter so as to make the data more exactly.

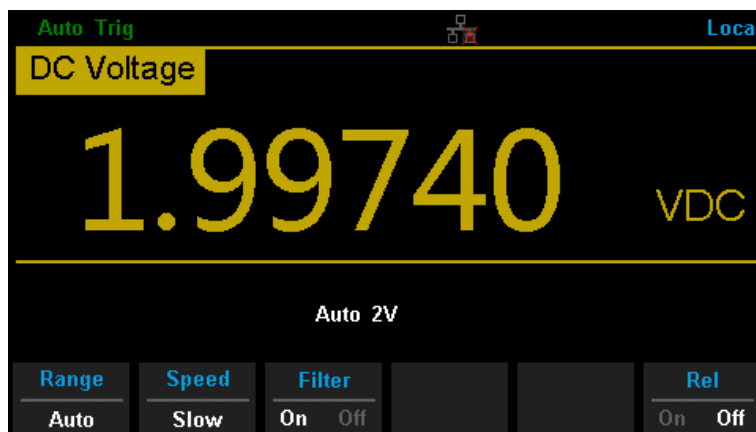

Diagram 2-35 Turn on or off AC Filter

### DC Input Impedance

DC input impedance is only applicable for DC voltage measurement. When DC Voltage function is selected, press [Range] and select [200mV] or [2V] to show the menu [Input Z], as the following diagram shows.

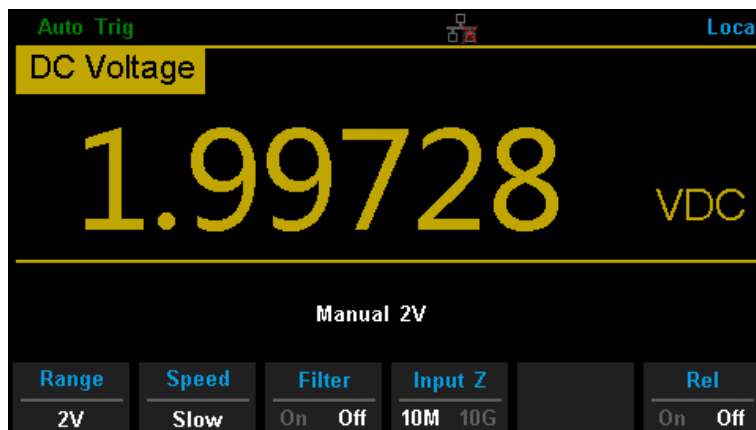

Diagram 2-36 Choose DC Input Impedance

The options of input impedance for DC voltage measurements are 10MΩ and 10GΩ. 10MΩ impedance is general for the Multimeter, but for 200mV and 2V manual ranges, 10GΩ should be

chosen for better result. The current selection will be saved in nonvolatile memory.

### DC input impedance selection:

- While the DC input impedance is selected as  $10M\Omega$ , the input impedance of all measurement range is  $10M\Omega$ ;
- While the DC input impedance is selected to  $10G\Omega$ , the input impedance for 200mV and 2V measurement range is  $10G\Omega$ ; for 20V, 200V and 1000V measurement range is kept at  $10M\Omega$ .
- The default value of DC input impedance is  $10M\Omega$ ; settings of DC input impedance are stored in the nonvolatile memory.

### Short-circuit Resistance

Set up the short-circuit resistance value in the short-circuit test menu. When the measured resistance is lower than the short-circuit resistance, the circuit is considered as connected, and the beeper sounds (if sound is turned on). The short-circuit resistance is only applicable to the continuity test.

Operating Steps:

1. When Continuity function is selected, press [Threshold] to enter interface as the following diagram.

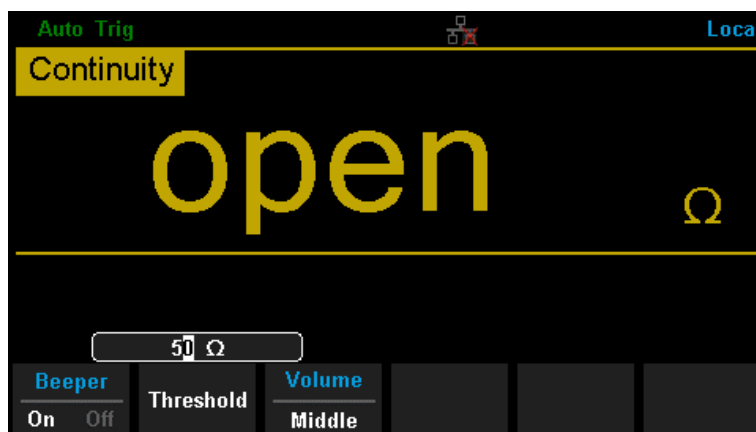

Diagram 2-37 Set Up the Short-circuit Resistance

2. Use direction keys to change the parameter values.  
Press left and right directional keys to choose different digits. Each press for the Left key, former number will be selected, vice versa. Press up and down keys to change the current digit value. Each press for the up key, value will be increased 1, vice versa.

### Short-circuit Resistance:

- The range of short-circuit resistance is  $0\Omega\sim 2000\Omega$ . The default value is  $50\Omega$ .
- The value of short-circuit resistance is stored in the nonvolatile memory and the resistance remains unchanged after the power is off.

## Dual-display Function

The Dual-display function is used to turn on two basic measurement functions, and observe the two measurement results at the same time, thus improve the test and measurement functions. For available combinations of Dual-display, refer to the following table.

Table 2-12 Available combination of Dual-display (letters in brackets correspond to Diagram 2-25 wiring example)



Correspond to Diagram 2-25 wiring example		Main Display Function								
		DCV	DCI	ACV	ACI	FREQ	PERIOD	2-Wire R	4-Wire R	Cap
Vice Display Function	DCV	(b)	(a) <sup>(1)</sup>	(b)	(a)					
	DCI	(a) <sup>(1)</sup>	(c)	(a) <sup>(1)</sup>	(c)					
	ACV	(b)	(a) <sup>(1)</sup>	(b)	(a)	(b)	(b)			
	ACI	(a)	(c)	(a)	(c)	(a)	(a)			
	FREQ			(b)	(a)	(b)				
	PERIOD			(b)	(a)		(b)			
	2-Wire R							(b) <sup>(2)</sup>		
	4-Wire R								(d)	
	Cap									(b) <sup>(3)</sup>

### Remarks:

- (1) Because connection (a) reverses the polarity of current line, DCI measurement shows its negative value.
- (2) At this time, connection (b) is not connected to power source, and "load" is the measured resistance.
- (3) In this case, connection (b) is not connected to power source, and "load" is the measured capacitance.

### Operating Steps:

#### 1. Enable the Dual-display function

First press a function key on the front panel to open the main display function, and then press , the upper right corner will show "Dual". By this time, press another function key to open the vice display function to complete the activation. When enabled, press  to switch the Main / Vice Display Function. If you need to exit dual function, just press the front panel to enter any function.

Take the Main Display DCV and the Vice Display DCI as an example, press **DCV** , **Dual** , **Shift** , and **DCV** .

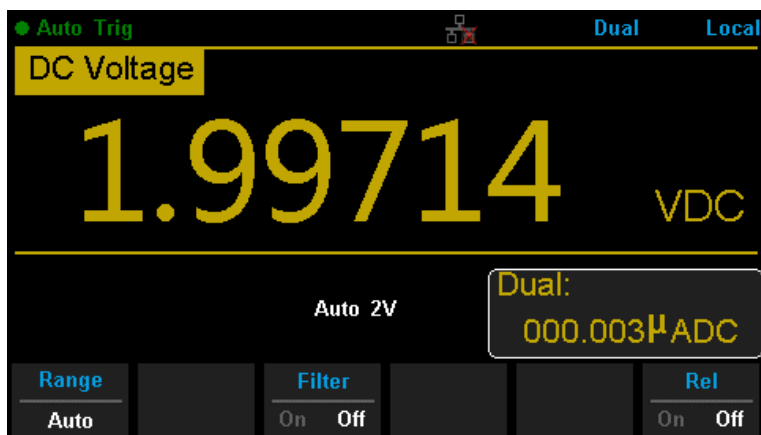

Diagram 2-38 Dual-display function Interface (Main DCV, Vice DCI)

**2. Make connection**

Connect the test leads with the measured signal by referring to “Measurement Connections”. As shown in the Diagram below, power source refers to connecting DC / AC power or not.

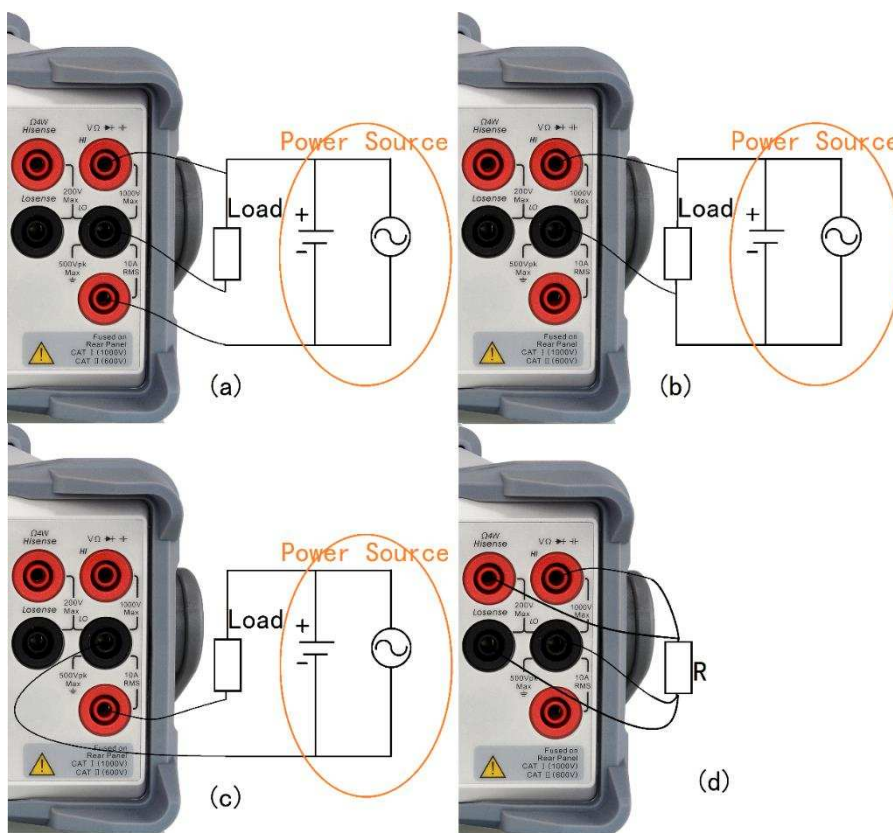



Diagram 2-39 Dual-display wiring example

**Instruction:**

- 1) If the same measurement function is used in both Main and Vice Display.
  - The readings in both of the display will update at the same time.
  - If math function (dBm, dB) is used in Main Display, when opening Vice Display, math operation will be closed automatically and Vice Display will show the same measurement result as Main Display.
  - If math function (Statistics, Limits, Relative) is used in Main Display, when opening Vice Display, the result will still be shown in Main Display and Vice Display will show the same measurement result as Main Display.
- 2) If different measurement functions are used in both Main and Vice Display.
  - The readings in both of the display will update alternately.
  - If math function (dBm, dB) is used in Main Display, when opening Vice Display, math operation will be closed automatically and Vice Display will show the second selected function normally.
  - If math function (Statistics, Limits, Relative) is used in Main Display, when opening Vice Display, the result will still be shown in Main Display and Vice Display will show the second selected function normally.
- 3) If Temperature function is used in Main Display, set the display mode (  → [Display] → [All]). Then the result will be shown in Main Display and the current measurement value is shown in Vice Display.
- 4) Auto Range is adopted by Vice Display. If the same measurement function is used in both the display, so does the range.
- 5) Measured data in Vice Display cannot be saved into “History”.

## Utility Function

The Utility function enables users to set up system parameters, interface parameters of the multimeters.

Press **Shift** and **Dual** to enter the operating menu of Utility function, as the following diagram shows.



Diagram 2-40 Utility Function Configuration Interface

Table 2-13 Utility Function Menu Description

Function Menu	Description
Store/Recall	Store or recall state files.
Manage File	Create a new file, copy, rename or delete a file.
I/O Config	Configure LAN and GPIB interface.
Test/Admin	Provide board test function.
System Setup	Configure instrument's user settings.

### Store and Recall

The Store/Recall function enables users to store and recall the instrument parameters and data files in the local storage as well as in USB storage.

Operating Steps:

1. After entering into the function menu of Utility, press [Store/Recall] to enter the interface as shown in diagram 2-40.

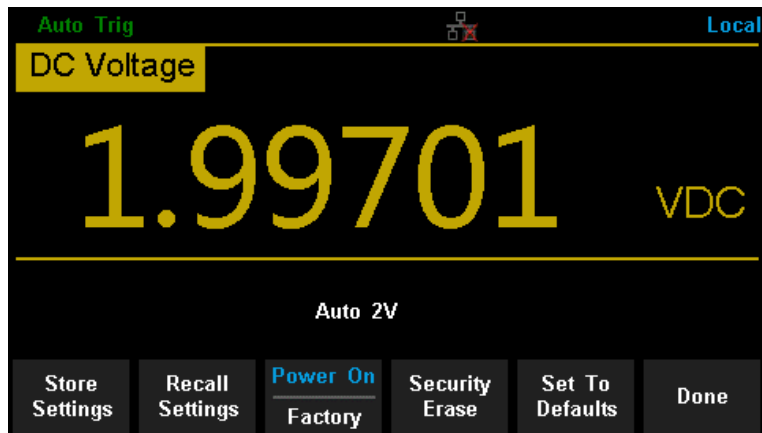

Diagram 2-40 Store and Recall Interface

2. Press [Store Settings] to enter the following interface.

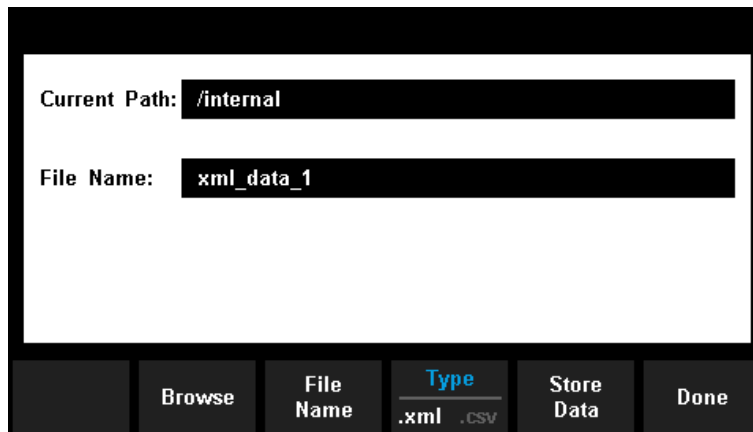

Diagram 2-41 Store Settings Interface

Table 2-14 Storage Function Menu Description

Function Menu	Settings	Description
Browse		Choose the location that file will be saved.
File Name		Input a file name.
Type	.xml / .csv	Choose the type that the file is saved.
Store MS Data		Save the file as input file name to the current selected location.
Done		Save all changes and return to the higher-level menu.

3. Press [Recall Settings] to enter the following interface. Use direction keys to choose storage path and location, and press [Select] to recall the corresponding file.



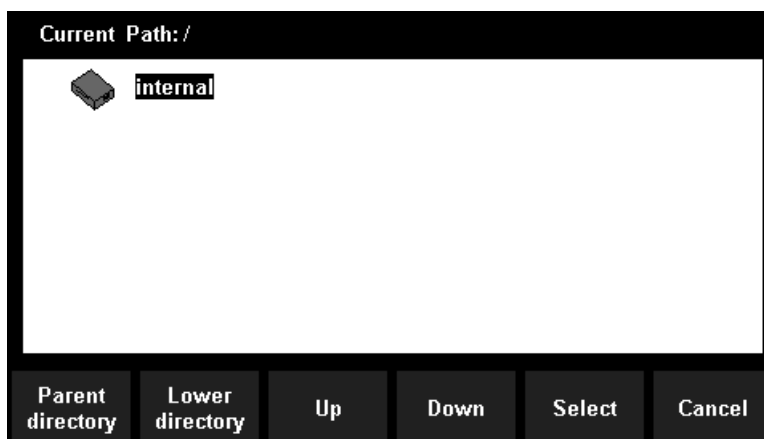

Diagram 2-42 Recall Function Interface

4. Press [Power on] to set the Power On state of the instrument.
  - You can choose [Last] or [Factory Default] as the initial state when the instrument is turned on.
  - The configuration is effective when you restart the Multimeter.
  - DC Voltage is always the selected function when the instrument is turned on even if you have selected [Last] or [Factory Default] as the Power On state.
5. Press [Set to Defaults] to select “Factory Default” as the Power On state.
6. Press [Security Erase] to erase all stored files and return the instrument to its factory default state.

## Manage File

The Manage File function enables users to create a new folder and save, copy, rename or delete files in the local storage as well as in USB storage.

Operating Steps:

1. After entering into the function menu of Utility, press [Manage File] to enter the interface as shown in diagram 2-43.

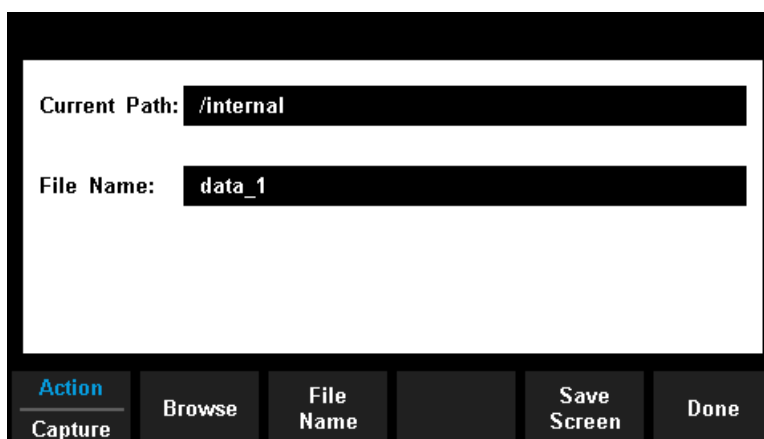

Diagram 2-43 Manage File Interface

2. Choose the file location.  
Press [Browse] and use direction keys to select the corresponding file.
3. Press [File Name] to enter the following interface.

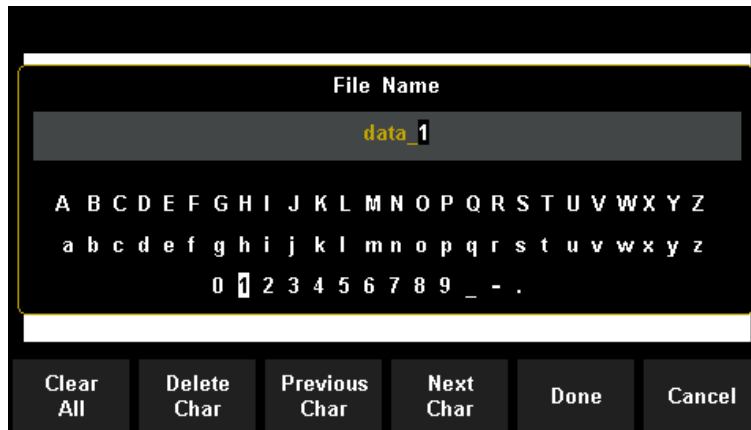

Diagram 2-44 Input File Name

The method of inputting file name:

- Press direction keys to select a desired char in the input area.
  - Press “OK” key on the front panel to input selected char in the input area.
  - Press [Clear All] to clear all input chars.
  - Press [Delete Char] to delete the letter on which the cursor taking place.
  - Press [Previous Char] to move the cursor in the file name area to the previous char.
  - Press [Next Char] to move the cursor in the file name area to the next char.
  - Press [Done] to save the current file and return to the higher-level menu.
  - Press [Cancel] to cancel the current operation and return to the higher-level menu.
4. Press [Action] and select [Folder], [Capture Display], [Copy], [Rename] or [Delete] to do the corresponding operation.

Table 2-15 Action Settings

Function Menu	Description
Folder	Press [Create Folder] to create a new folder.
Capture Display	Press [Save Screen] to save current captured screen picture as standard BMP format.
Copy	Press [Perform Copy] to copy the selected file.
Rename	Press [Perform Rename] to rename the selected file.
Delete	Press [Perform Delete] to delete the selected file.
Done	Save all changes and return to the higher-level menu.

## I/O Configuration

Press [I/O Config] to enter the following interface and set up the parameters.

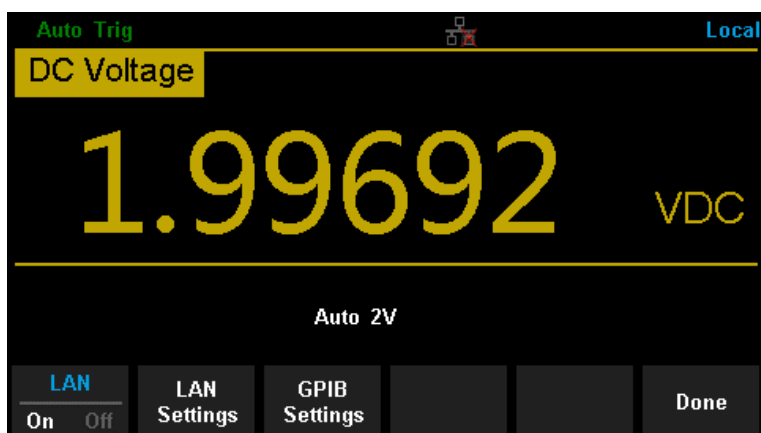

Diagram 2-45 I/O Configuration Interface

## LAN Settings

The Multimeter enables users to operate instrument remotely by LAN interface and store or recall internet settings. You can look over current LAN settings and set up IP address and subnet mask. After entering into the function menu of Utility, press [I/O Config] , Select [on] → [LAN Settings] → [Modify Settings] to enter the following interface.

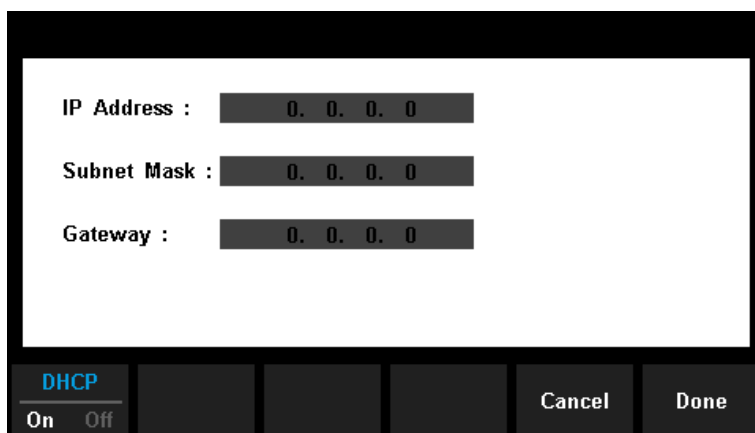

Diagram 2-46 LAN Settings Interface

Table 2-16 LAN Settings

Function Menu	Description
IP Address	Set up IP address and the default setting is 10.11.11.104.
Subnet Mask	Set up subnet mask and the default setting is 255.0.0.0.
Cancel	Cancel current operation and return to the higher-level menu.
Done	Save all changes and return to the higher-level menu.

## Operating Steps:

1. After entering into the function menu of I/O configuration, press [GPIB Settings] to enter the interface shown in diagram 2-45.



Diagram 2-47 GPIB Settings

2. Users can change the value of GPIB address by direction keys.
3. Press [Select] to set the input value as GPIB address and return to the higher-level menu.

**Board Test**

**SDM3055** provides self-test functions, including Key Test, LCD Test, Beeper Test and Chip Test.

## Operating Steps:

1. Press **Shift** and **Dual** , then choose [Test/Admin] → [Board Test] to enter the following interface.

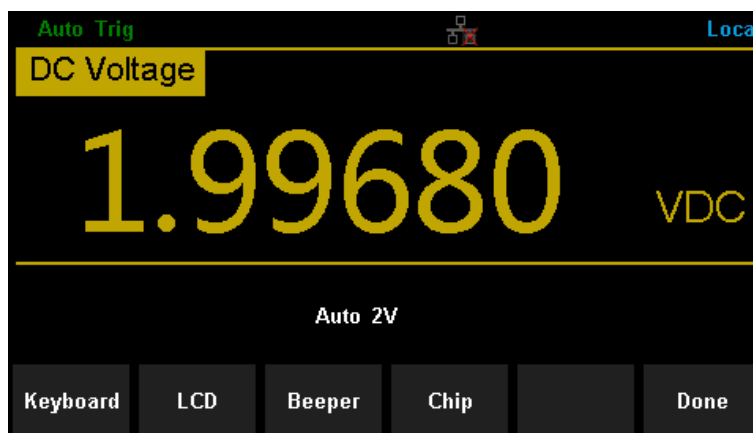

Diagram 2-48 Board Test Interface

Table 2-17 Board Test Function Description

Function Menu	Description
Key	Test the instrument's keys.
LCD	Test the instrument's LCD screen.
Beeper	Test the instrument's beeper.
Chip	Test the instrument's chips.
Done	Return the higher-level menu.

## 2. Test the keys.

Select [Key] to enter the key test interface, as the Diagram 2-47 shows. The on-screen lathy rectangle shapes represent the keys on the front panel. Test all keys and knobs and you should also verify that all the backlit buttons illuminate correctly.

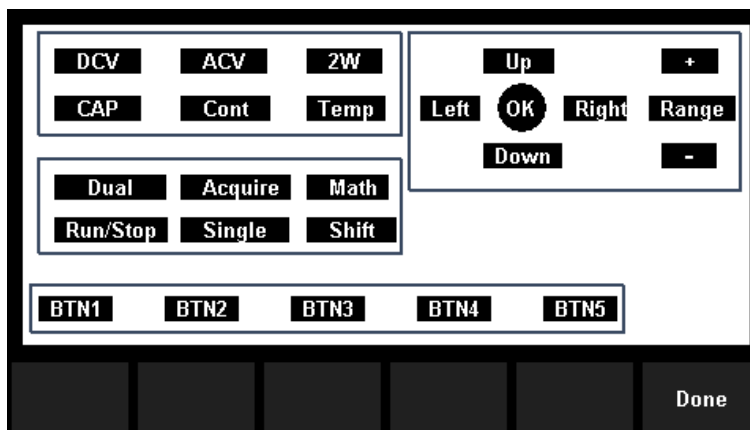

Diagram 2-50 Key Test Interface

**NOTE:**

- Before you operate, the shapes on the screen display blue color.
- The corresponding area of tested buttons or knobs would display green color.
- Press [Done] to exit the test.

## 3. Test the LCD screen.

Select [LCD] to enter the screen test interface, the screen shows the message: **“Press ‘Change’ to change Press ‘Done’ to exit”**. Press [Change] to start the test and observe if the screen has severe color or other display error. As the Diagram 2-50 shows.

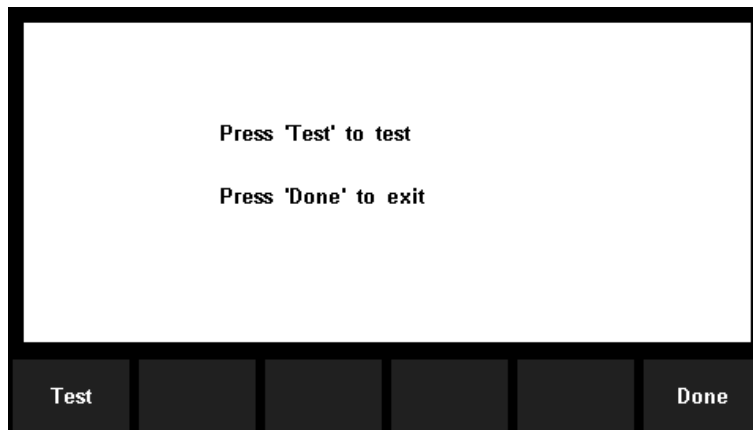

Diagram 2-49 LCD Test Interface

**NOTE:**

- Press [Change] to change the color of the screen. There are three colors: red, blue and green.
- Press [Done] to exit the test.

## 4. Test the beeper.

Press [Beeper] to test the beeper. Under regular circumstance, press [Beeper] one time and the instrument will beep one time.

## 5. Test the chips.

Press [Chip] → [Start] to enter chip test interface, as Diagram 2-51 shows.

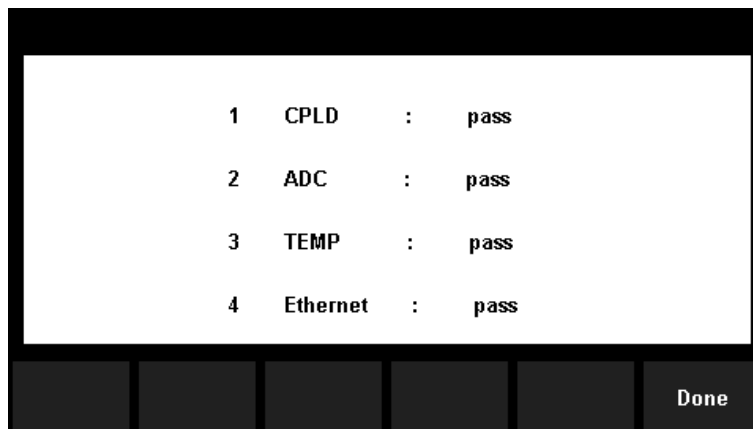

Diagram 2-50 Chip Test Interface

**NOTE:**

- If the test is passed, the corresponding result shows “pass”.
- If the test is failed, the corresponding result shows “fail”.

## 6. Press [Done] to exit the board test.

## Firmware Update

The software of the Multimeter can be updated directly via USB flash drive, updating current software version to desired software version.

Operating Steps:

1. Copy the update file to the USB flash drive.
2. Insert USB flash drive to USB host interface on the front panel of the Multimeter.
3. Press **Shift** → **Dual** → [Test/Admin] → [Firmware Update], then press [Browse] and select the update file. Next, press [Update] → [Yes] to start updating the system software.
4. After accomplishing update, the screen shows message:  
“Firmware Update Done!” Then you can move the USB flash drive away.
5. Restart the Multimeter and check the version information.  
Press **Shift** → **Dual** → [System Setup] → [System Info] to check if the software and hardware version after updating is in accordance with the desired version. If not, the updating is failed and you need update once more as the above steps.
6. After checking, press [Done] to exit the system information interface.

### NOTE:

Don't cut off the power during the instrument is updating

## System Setup

Press **Shift** and **Dual** , then select [System Setup] to enter the following interface.

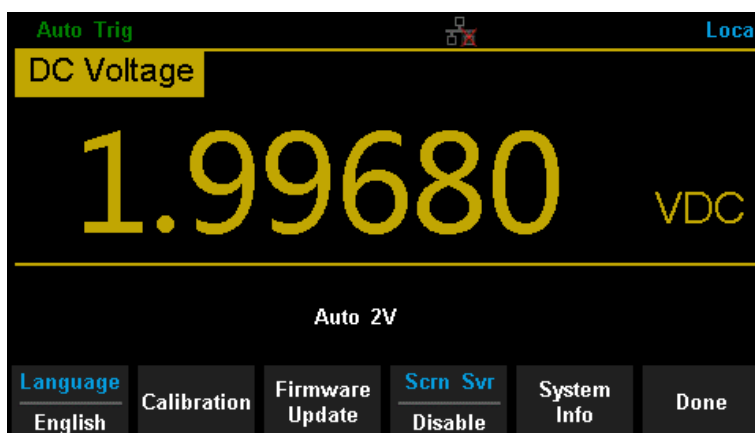

Diagram 2-51 System Setup Interface

Table 2-18 System Settings Menu Description

Function Menu	Description
Language	Select the display interface language.
Calibration	Recalibration function.
Firmware Update	System firmware update by user.
Screen	Set up the screen protection function.
System Info	View system information.
Done	Return to the higher-level menu.

1. Select language.

The Multimeter supports two kinds of languages, English and Chinese. Press [Language] to enter the following interface.

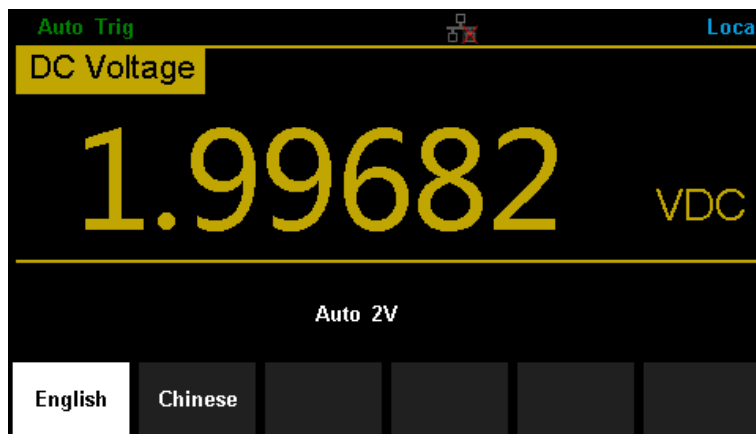

Diagram 2-54 Choose Language

2. User recalibration.

3. Set up the time of screen protection.

Press [Screen] to set screen protection as 1 Min, 5 Mins, 15 Mins, 30 Mins, 1 Hour, 2 Hours or 5 Hours according to different demands. Activate the screen saver program and screen saver will be on if no action is taken within the time that you have selected. Press any button the resume.

4. View system information.

Press [System Info] to view system information, including startup times, software version, hardware version, production ID and serial number, as shown in the following diagram.



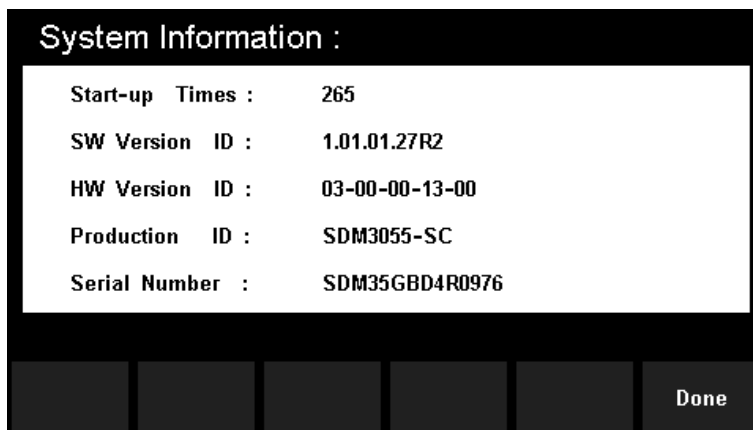



Diagram 2-52 System Information

## Acquire

Sampling is a process of acquiring and digitizing signal. The optional Trigger methods of the Multimeter include Auto Trigger, Single Trigger and External Trigger.

Press  to enter the interface shown as the following diagram:

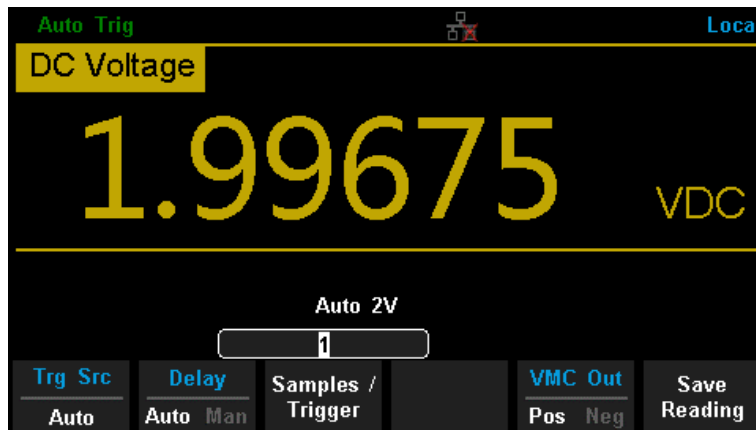

Diagram 2-53 Acquire Interface



Table 2-19 Function Menu of triggering parameter

Function Menu	Description
Trg Src	Set the source of trigger.
Slope	Set the slope polarity of external trigger.
Delay	Set the delay.
Samples/Trigger	Set the number of samples or trigger.
VMC Out	Set the polarity of output pulse signal when sampling signal is finished.

### Auto Trigger

Auto Trigger parameters that need to be set up include delay, samples /trigger and VMC out.

Operating Steps:

1. Press , then select [Trg Src] → [Auto] or press  on the front panel directly to enable Auto Trigger.
2. Set the delay.  
Delay is the waiting time after the trigger signal is sent out and before the acquiring starts. Press

[Delay] to select Auto or Manual mode. When choosing Manual mode, Left and Right keys are used to switch the number of a numerical value, Up and Down keys are used to change the selected value.

3. Set the number of samples or trigger.

Press [Samples/Trigger] to set the sample count. Left and Right keys are used to switch the number of a numerical value, Up and Down keys are used to change the selected value.

### Sample Count

- Sample Count indicates the count of point sampled while the Multimeter getting a signal of Single Trigger.
- The range of sampling point should be between 1 and 599999999.
- The default value of Sample Count is 1.

4. Set the VMC Out.

Press [VMC Out] to choose Positive or Negative polarity.

### Single Trigger

Single Trigger parameters that need to be set up include delay, samples /trigger and VMC out.

Operating Steps:

1. Press **Acquire**, then select [Trg Src] → [Single] or press **Single** on the front panel directly to enable Single Trigger. See the diagram below.

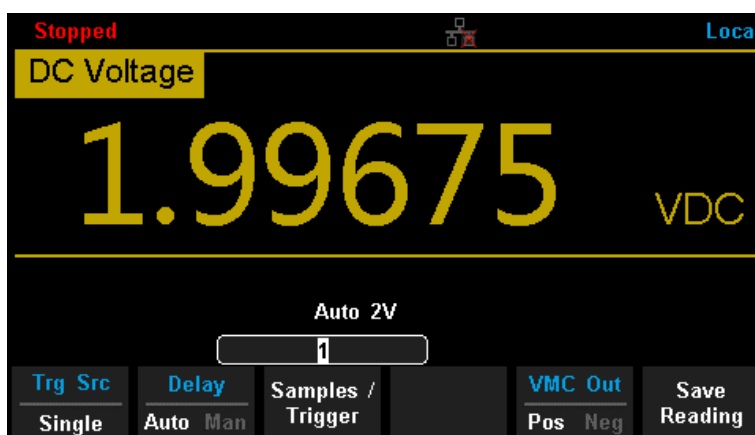

Diagram 2-54 Setting interface of Auto Trigger

2. Set the delay.

Press [Delay] to select Auto or Manual mode.

3. Set the number of samples or trigger.  
Press [Samples/Trigger] to set sample count.
4. Set the VMC Out.  
Press [VMC Out] to choose Positive or Negative polarity.

### External Trigger

The external trigger signal will be input via EXT TRIG interface on the rear panel. External trigger parameters that need to be set up include delay, samples /trigger, slope and VMC out.

Operating Steps:

1. Press **Acquire**, then select [Trg Src] → [Ext] or press **Single** on the front panel directly to enable External Trigger.

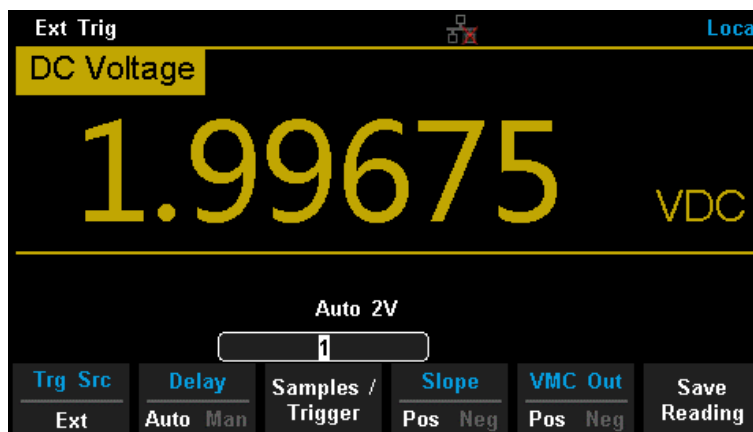

Diagram 2-55 Setting interface of Ext Trigger

2. Set the polarity of slope.  
Press [Slope] to choose Positive or Negative polarity.
3. Set the delay.  
Press [Delay] to choose Auto or Manual mode.
4. Set the number of samples or trigger.  
Press [Samples/Trigger] to set sample count.
5. Set the VMC Out.  
In External Trigger mode, the Multimeter could output a pulse signal through the VM COMP interface on the rear panel after sampling signal is finished.

## Help System

SDM3055 provides powerful built-in help system. You can recall help information at any time during using the instrument. You also can get a particularly help for every button on the front panel or menu softkey by using the built-in help system. Or you can get help about familiar operations with the help list.

Press **Shift** and **Acquire** to enter the help list, as the following diagram shows.

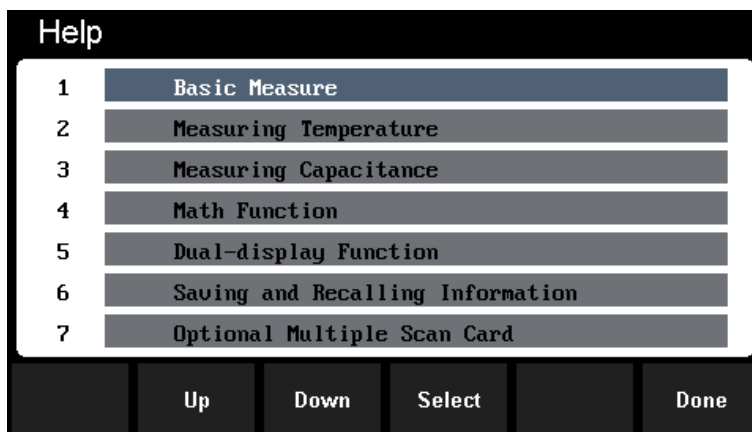

Diagram 2-56 Help Menu

Table 2-20 Help System Operating Menu

Function Menu	Description
Up	Move up the cursor and select the help menu.
Down	Move down the cursor and select the help menu.
Select	Select the help information you want and read it.
Done	Return to the higher menu.

1. Basic Measure.  
Get basic measurement types and methods to connect the leads in different measurements.
2. Measuring Temperature.  
Get the method to measure temperature.
3. Measuring Capacitance.  
Get the method to measure temperature.
4. Math Function.  
Introduce how to use the math function while you are measuring.

5. Dual-display Function.  
Get the method to use the dual-display function while you are measuring.
6. Saving and Recalling Information.  
Introduce how to store and recall the data/parameter/ sensors files.
7. Optional Multiple Scan Card.  
Get help about operating optional multiple scan cards.
8. The convention and Tips of Softkeys.  
Get help about the convention and tips of softkeys.
9. Technical Support.  
Get the method to obtain technical support.

**Explanation:**

- In the help menu interface, you also can move cursor and select the corresponding menu by up and down direction keys and press "OK" to read the help information.
- While reading help information, you also can look up and down the information by up and down direction keys.

## Math Function

The Multimeter provides five math functions: Statistics, Limits, dBm, dB and Relative. Choose different math functions to meet different measurement demands. Math functions can only be used in DC Voltage, AC Voltage, DC Current, AC Current, Resistance, Frequency, Period and Temperature measurement. Among these functions, dBm and dB are only used in DC Voltage and AC Voltage measurement.

Press **Math** to show the operating menu of math functions on the screen, as shown in the following diagram.

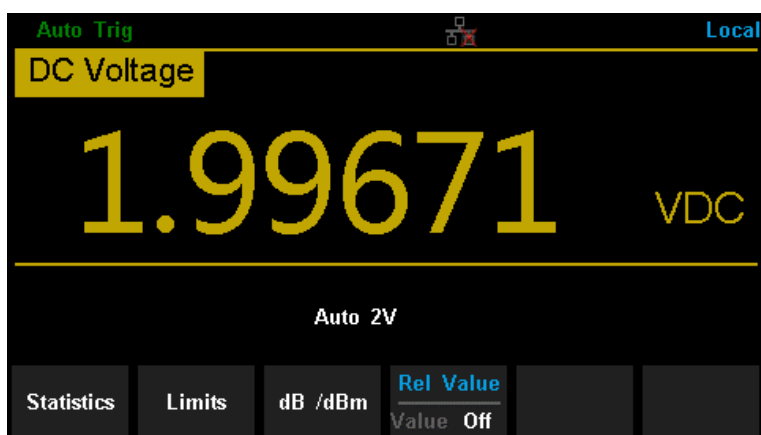

Diagram 2-60 Math Function Menu of DC Voltage

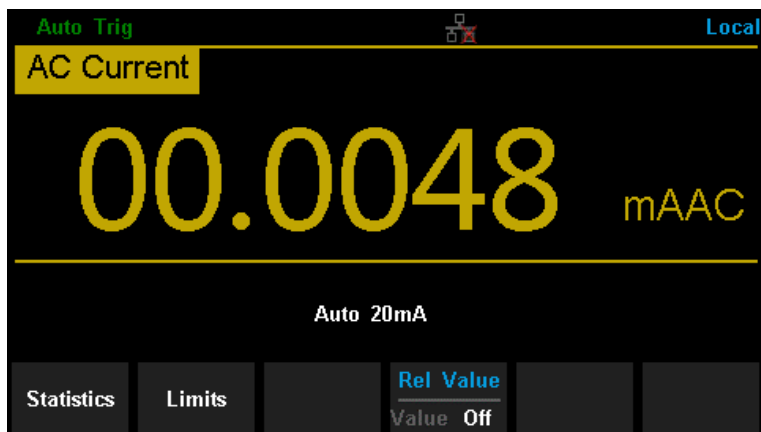

Diagram 2-57 Math Function Menu of AC Current

Table 2-21 Math Function Menu Description

Function Menu	Settings	Description
Statistics		Reading statistic functions, including: max, min, average, span, std dev and samples.
Limits		The Limits function performs Pass/Fail testing according to the specified upper and lower limits.
dBm		The dBm is based on a calculation of power delivered to a reference resistance, 0dBm = 1 mW.
dB		The dB measurement is the difference between the input signal and a stored relative value.
Rel Value	Value/Off	Turn on the relative value function and set up the value. Or turn off the function.

**Explanations:**

- Math function can only be applicable to the main display.
- If measurement function is changed, all math functions will be closed except Statistics.

**Statistics**

There are many kinds of reading statistic functions, including: Max, Min, Average, Standard deviation and so on. The Statistic function is available for DC Voltage, AC Voltage, DC Current, AC Current, Resistance, Frequency, Period, Capacitance and Temperature measurement.

Press  → [Statistics] → [Show] to enter the interface shown in the following diagram.

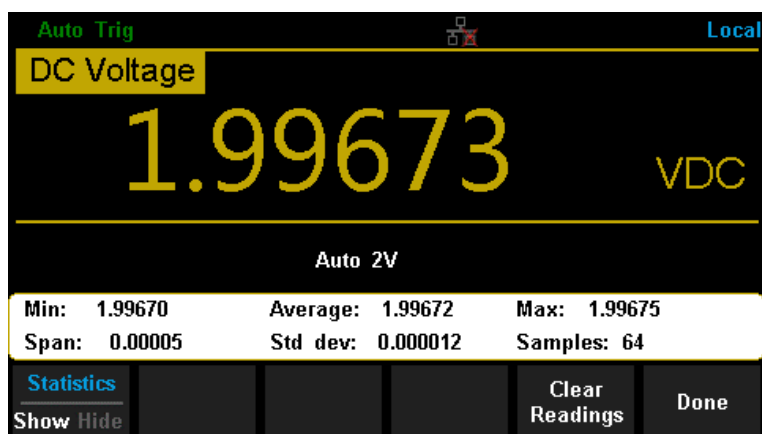

Diagram 2-58 Statistics



Table 2-22 Statistic Measurement Menu Function Description

Function Menu	Settings	Description
Statistics	Show/Hide	Show or hide the statistics function interface.
Min		Show the minimum statistics value of current measurement.
Average		Show the average statistics value of current measurement.
Max		Show the maximum statistics value of current measurement.
Span		Show the span of current measurement.
Std dev		Show the std dev statistics value of current measurement.
Samples		Show the maximum statistics value of current measurement.
Clear Readings		Clear all current readings and restart statistics.
Done		Return to the higher-level menu.

### Statistics Function:

- In statistic function, the first reading is usually set to the maximum or minimum value. When getting more readings, current displaying value is always the maximum/minimum reading among all the measured values.
- The maximum, minimum, average and reading quantities are stored in volatile memory.

### Limits

Limits function is available to prompt signals beyond ranges according to the upper and lower parameters. Following are some measurement functions which are able to do limit operation: DC Voltage, AC Voltage, DC Current, AC Current, Resistance, Frequency, Period, Capacitance and Temperature.

Press **Math** → [Limits] → [On] to enter the interface shown in the following diagram.

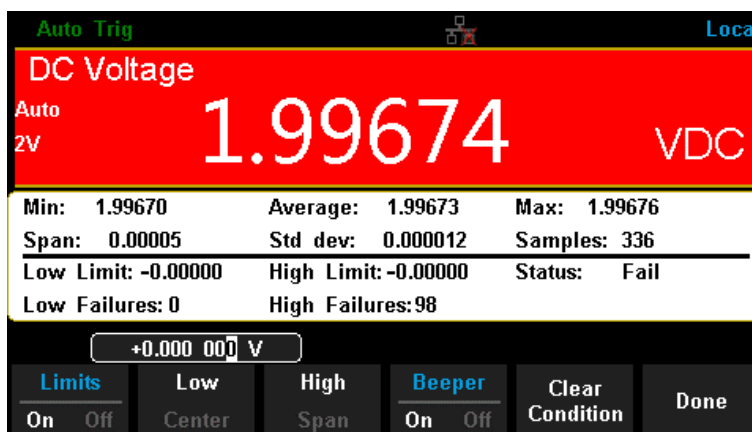

Diagram 2-59 Limits

Table 2-23 Limits Measurement Menu Function Description

Function Menu	Settings	Description
Limits	On/Off	Turn on or turn off the Limits function.
Low		Set the desired lower limit.
Center		Set the desired center value
High		Set the desired upper limit.
Status		Show the status of limit test.
Low Failures		Show the times that reading is lower than the limit.
High Failures		Show the times that reading is higher than the limit.
Span		Set the desired span.
Beeper	On/Off	When the beeper is on, if the reading is lower or higher than limits, the instrument will beep once.
Clear Condition		Clear all current readings and restart to test.
Done		Save all changes and return to the higher-level menu.

### 1. How to Set Limits

Select [High], [Low], [Center] or [Span] and then switch to the needed digit by Left or Right Direction keys and input numerical value by Up and Down Direction keys.

### 2. Unit

The unit of Limits is decided by the current measurement function.

### 3. Over hint

- When the reading is lower than the set lower limit, the color of main display will switch blue to red.
- When the reading is higher than the set higher limit, the color of main display will switch blue to red.
- When the reading is lower or higher than the set limits, the Beeper will beep once. (The beeper is turned on.)

### The range of Limits function:

- The Limits range is -120% ~ +120% of the current measurement range.
- The upper limit value should be always bigger than the lower limit value.
- The upper and lower values are stored in volatile memory. They will be set to default values when the power is on.

## dBm

The dBm function is logarithmic and based on a calculation of power delivered to a reference resistance, relative to 1 mill watt. Besides, this function only applies to AC voltage and DC voltage measurements.

Press **Math** → [dB/dBm] → [On] and select [Function dBm] to enter the interface shown in the following diagram.

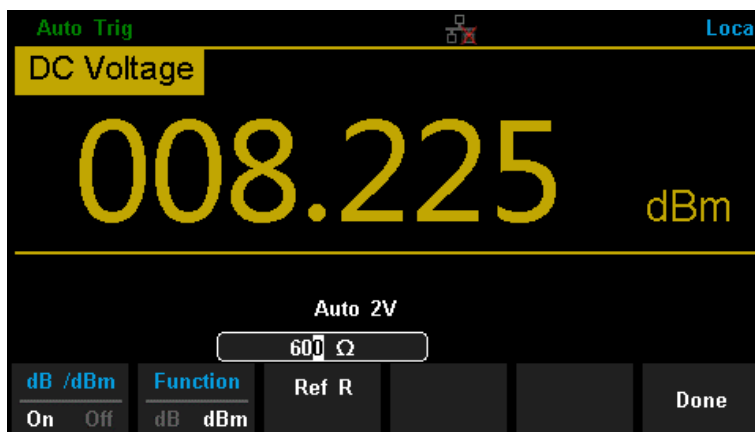

Diagram 2-60 dBm Function Interface

Table 2-24 dB Measurement Function Menu Function Description

Function Menu	Settings	Description
dB/dBm	On/Off	Turn on or turn off dB or dBm function.
Function dBm		Open dBm function and the lower right corner of the main display show "dBm".
Ref R		Set the parameter via direction keys: 50Ω ~ 8000Ω.
Done		Save all changes and return to the higher-level menu.

### The computation method of the dBm:

When dBm function is turned on, the measured value of voltage is transformed into dBm according to the following formula.

$$\text{dBm} = 10 \times \text{Log}_{10} [(\text{Reading}^2 / \text{RREF}) / 0.001\text{W}]$$

## dB

Each dB measurement is different between the input signal and a stored relative value, with both values converted to dBm. The dB function applies to AC voltage and DC voltage measurements only.

Press **Math** → [dB/dBm On] and select [shown in the following diagram. Function dB] to enter the interface

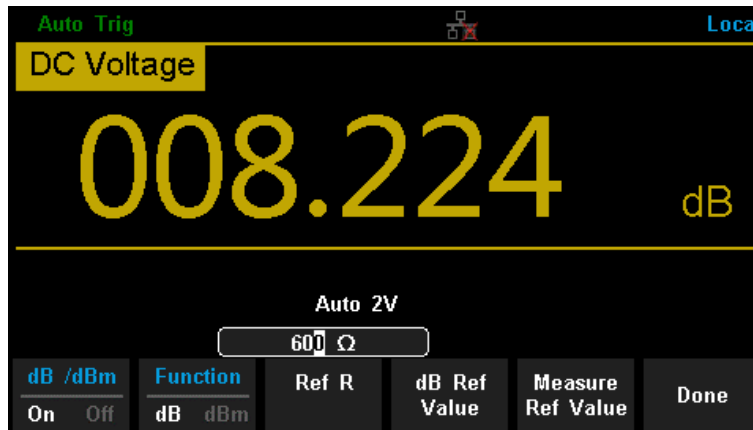

Diagram 2-61 dB Function Interface

Table 2-25 dB Measurement Function Menu Function Description

Function Menu	Settings	Description
dB/dBm	On/Off	Turn on or turn off dB or dBm function.
Function dB		Open dB function and the lower right corner of the main display show “dB”.
Ref R		Set the parameter via direction keys: 50Ω ~ 8000Ω.
dB Ref / Value		Set the referred value of dB.
Measure / Ref Value		Set the referred value of measurement.
Done		Save all changes and return to the higher-level menu.

### The computation method of the dB:

$$\text{dB} = 10 \times \text{Log}_{10} [(\text{Reading}^2 / R_{\text{REF}}) / 0.001\text{W}] - (\text{dB setting value})$$

$R_{\text{REF}}$  expressed measuring the resistance value in the actual electric circuit. Range of the dB setting value: -120 dBm ~ +120 dBm. The default is 0 dBm.

### dB value:

- Input a value in dB setting interface by direction button, and then store it as dB setting value.
- Settings of dB value are stored in volatile memory.

## Relative Value

Relative value is used for relative measurement. Actual measurement reading is the depression between measurement value and preset value.

The Multimeter allows operating for the following parameters: DC Voltage, AC Voltage, DC Current, AC Current, Resistance, Frequency, Period, Capacitance and Temperature.

Press **Math** → **[Rel Value]** to enter the interface shown in the following diagram.

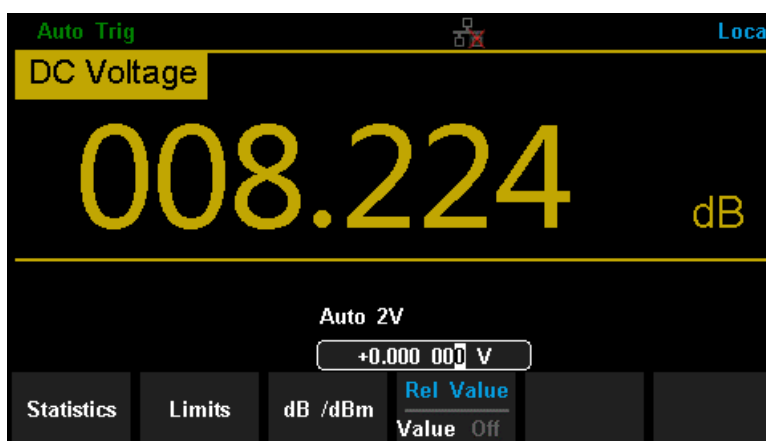

Diagram 2-62 Relative Operation

Table 2-26 Rel Value Operation Function Menu

Function Menu	Description
Value	Select current measurement value as preset value.
Off	Turn off the relative operation function.

### The computation method of the dB:

When dBm function is turned on, the result of relative measurement will show on the screen.

Main display = Measurement value – Preset value

## Display Mode

The Multimeter supports four types of way to view measured data: “Number”, “Bar Meter” “Trend Chart” and “Histogram”.

### Number

Press **Shift** and **Math** to open the menu of display mode and press [Display] to enter the following interface. “Number” is always the selected mode when the Multimeter is turned on.

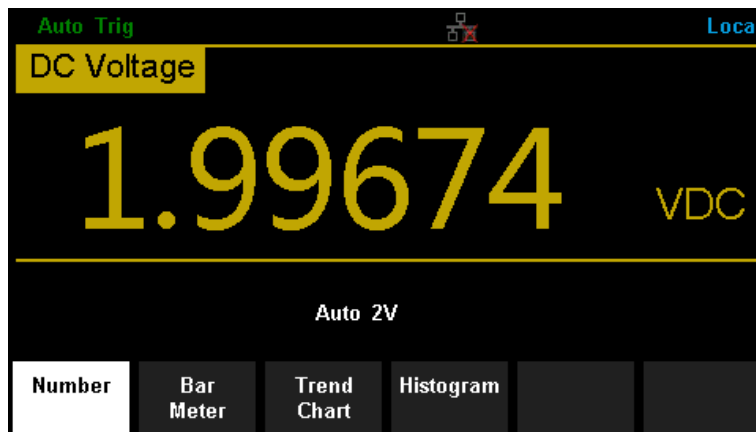

Diagram 2-67 Number Display Mode

### Bar Meter

Operating Steps:

1. Press [Bar Meter] to enter Bar Meter display mode.

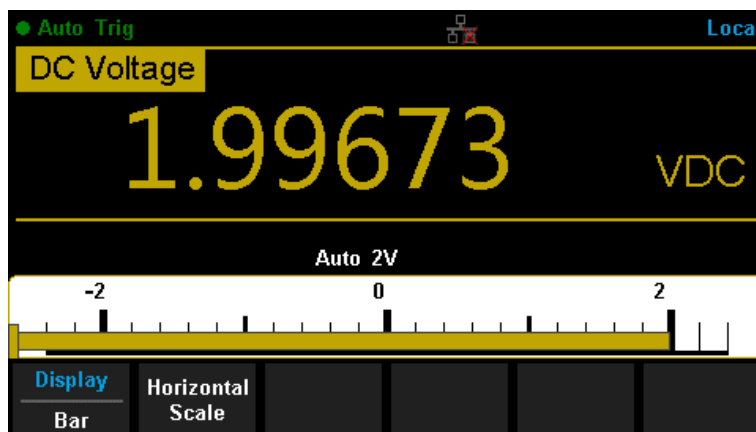

Diagram 2-63 Bar Meter Display Mode

2. Press [Horizontal Scale] to choose the way to set the vertical scale as Default or Manual mode.

Table 2-27 To Set the Vertical Scale of Bar Meter manually

Function Menu	Description
Low	Set the low value of horizontal scale.
High	Set the high value of horizontal scale.
Center	Set the center value of horizontal scale.
Span	Set the span of horizontal scale.
Done	Save all changes and return to the higher-level menu.

## Trend Chart

Operating Steps:

1. Press [Trend Chart] to enter Trend Chart display mode. The default vertical scale is -2V to 2V when DC Voltage measurement is selected.

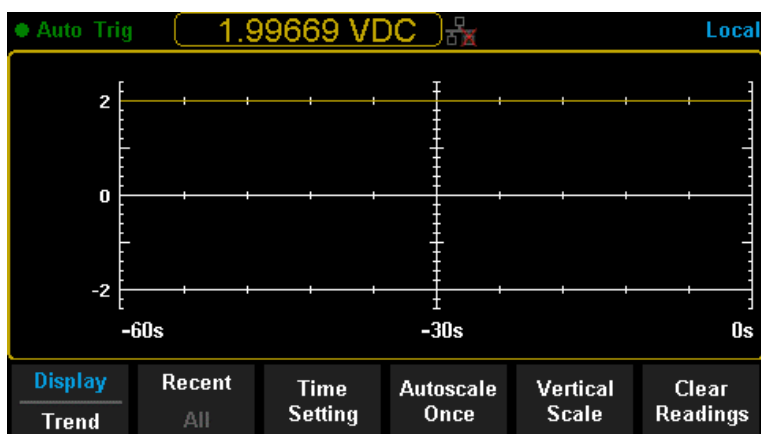

Diagram 2-64 Trend Chart Display Mode

Table 2-28 Trend Chart Display Mode

Function Menu	Description
Display / Trend	Currently selected display mode is Trend Chart.
Recent / All	Show recent or all readings.
Time Setting	Set Trend Chart time axis.
Autoscale Once	Automatically set the horizontal scale once.
Vertical Scale	Choose the mode of Vertical Scale.
Clear Readings	Clear all current readings and restart statistics.

2. Press [Vertical Scale] to choose the way to set the vertical scale as Default, Auto or Manual mode. Press [Auto] and the Multimeter will set the vertical scale automatically.

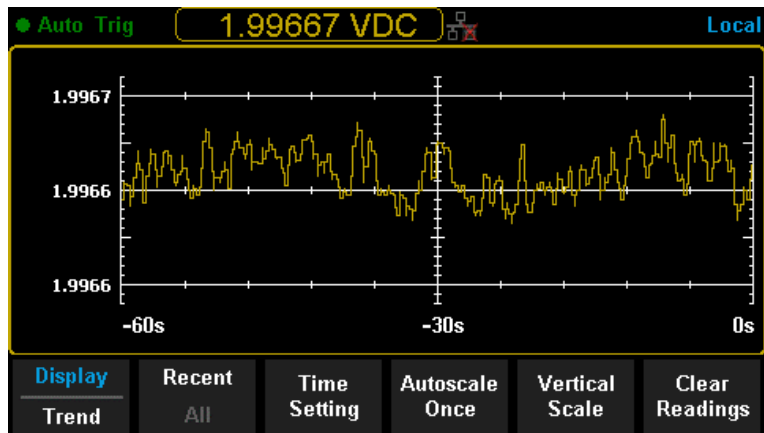

Diagram 2-70 Auto Vertical Scale

Press [Manual] and you can set the vertical scale manually, as the following diagram shows.

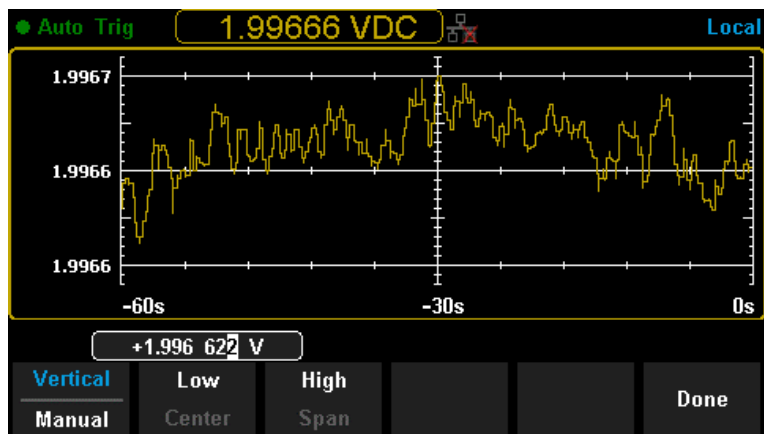

Diagram 2-65 Manual Vertical Scale

## Histogram

Operating Steps:

1. Press [Histogram] to enter Histogram display mode.

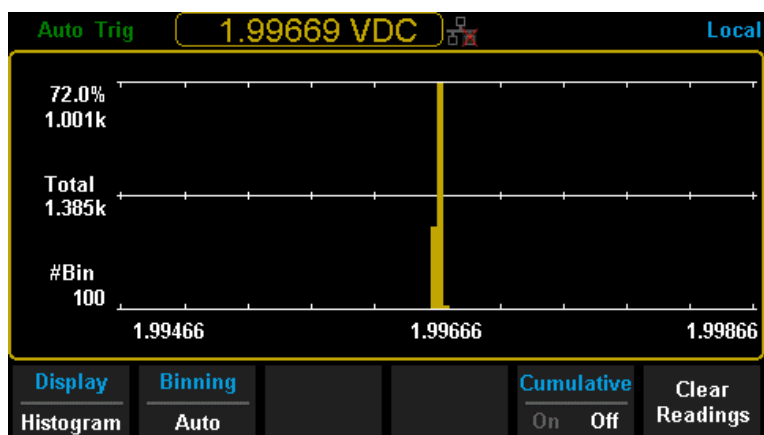

Diagram 2-66 Histogram Display Mode



Table 2-29 Histogram Display Mode

Function Menu	Settings	Description
Display Histogram		Currently selected display mode is Histogram.
Binning		Set Binning as Auto or Manual mode.
Bin Set		Set the parameters of Bin.
Cumulative	On/Off	Turn on or off Cumulative function.
Clear Readings		Clear all current readings and restart statistics.

- Press [Binning] to choose the way to set Binning as Auto or Manual mode. When in Manual mode, press [Bin Settings] to enter the following interface.

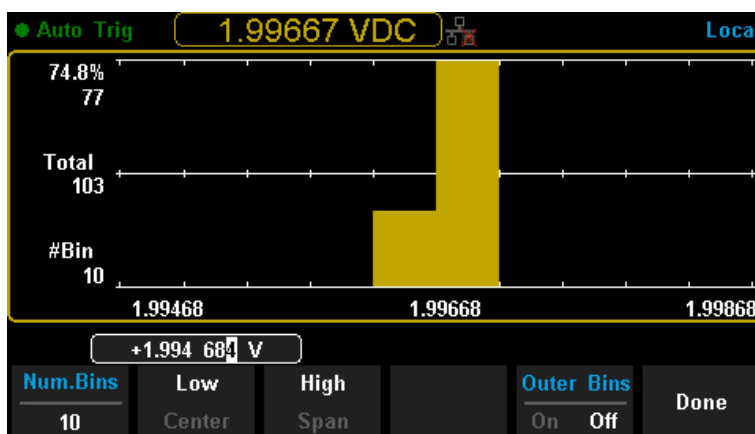



Diagram 2-67 Bin Set Interface

Table 2-30 Bin Set

Function Menu	Settings	Description
Num.Bins		Set the number of Bins, 10, 20, 40, 100, 200 or 400 selected.
Low		Set the low value of horizontal scale.
High		Set the high value of horizontal scale.
Center		Set the center value of horizontal scale.
Span		Set the span of horizontal scale.
Outer Bins	On/Off	Show the bins beyond the scope or not.
Done		Save all changes and return to the higher-level menu.

## Trigger

The Multimeter supports Trigger function. Press  or  on the front panel to trigger the Multimeter by Auto or Single mode. Auto trigger is considered as a default when the power is on.

### Auto Trigger

Press  on the front panel one time and Auto Trigger will be started to capture continuous readings automatically. By the time, the black field of the screen will show “● Auto Trigger”. Press again and the trigger is stopped.

### Single Trigger

Press  on the front panel, Single Trigger will be started one time and generate an effective reading. By the time, the black field of the screen will show “● Single Trigger”.

### Explanation:

In Remote Mode, the black field just above the screen will show “● ImmediateTrigger”. Press  to switch back to the local mode and the Multimeter will choose Auto Trigger automatically.

## Hold Measurement Function

Hold Measurement function provides users with a stable reading on the screen of the front panel. When the test leads are put away, the reading is still held on the screen, which makes users can view measured history data.

Press **Shift** and **Single** to open Hold measurement function interface, the black field just above the screen will show “●Probe Hold”, as shown in the following diagram.

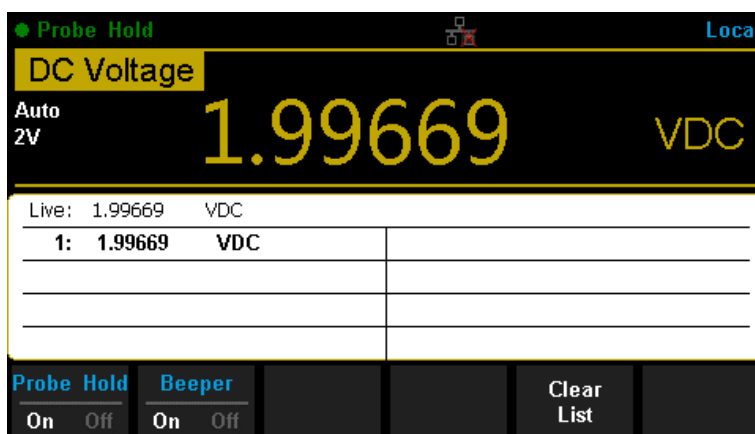

Diagram 2-68 Hold Measurement Function Interface

Table 2-31 Hold Measurement Function

Function Menu	Settings	Description
Probe Hold	On/Off	Turn on or off Probe Hold function.
Beeper	On/Off	Turn on or off the Beeper.
Clear List		Clear all current readings and restart to statistics.

## Chapter 3      Application Examples

This chapter mainly introduces few application examples to help users control and manipulate SDM3055 quickly.

- Example 1: Reading Statistic Functions
  
- Example 2: To Eliminate Leads Impedance
  
- Example 3: dBm Measurement
  
- Example 4: dB Measurement
  
- Example 5: Limits Test
  
- Example 6: Thermocouple Setting and Measurement
  
- Example 7: To Use Hold Measurement Function
  
- Example 8: To Use Application Software EasySDM

## Example 1: Reading Statistic Functions

Introduce how to realize the statistic function during measuring. When continually measuring few readings, the Multimeter will update statistic values constantly.

Operating Steps:

1. Press **ACV** on the front panel to select AC Voltage measurement function and choose a proper voltage range.
2. Connect the red lead to terminal Input-HI and black lead to terminal Input-LO as Diagram 2-9.
3. Set the Statistics function parameters.  
Press **Math** → [Statistics] to turn on the statistics function.
4. Lead test leads into the circuit and start to measure. Statistics will update with the increasement of samples, as the following diagram shows.

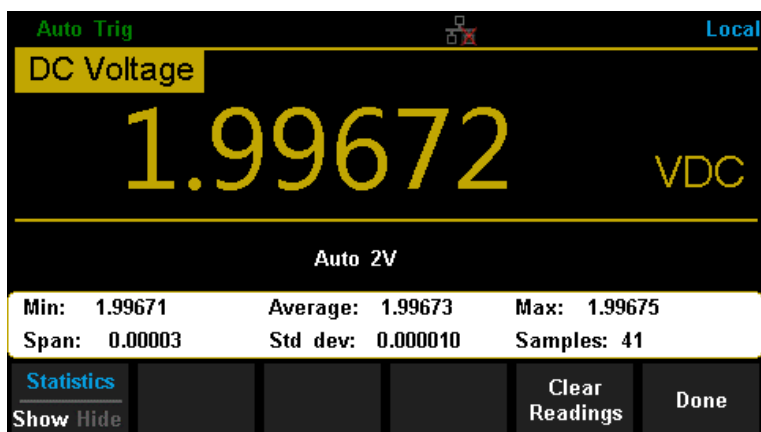

Diagram 3-1 Statistics 1

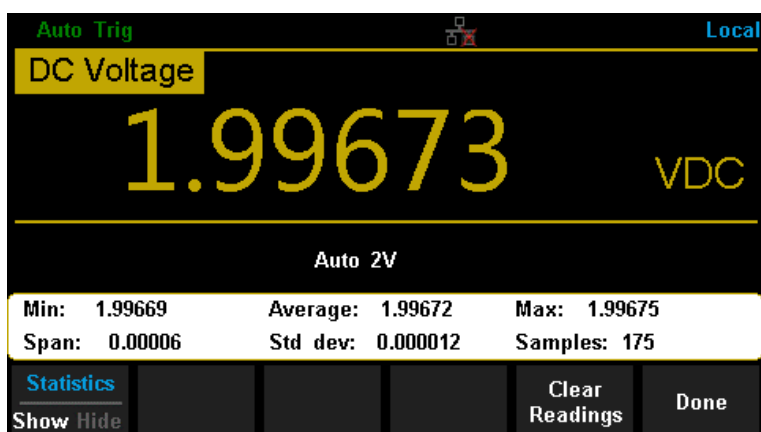

Diagram 3-2 Statistics 2

## Example 2: To Eliminate Leads Impedance

Relative Operation could eliminate impedance errors from leads when measuring smaller resistance.

Operating Steps:

1. Press  $\Omega 2W$  on the front panel to select 2-Wire Resistance measurement function.
2. Connect the red lead to terminal Input-HI and black lead to terminal Input-LO as Diagram 2-14.
3. Choose a proper resistance range according to the scope. The default is Auto Range.
4. Lead impedance will be shown on the screen as follow after connecting with two leads together.

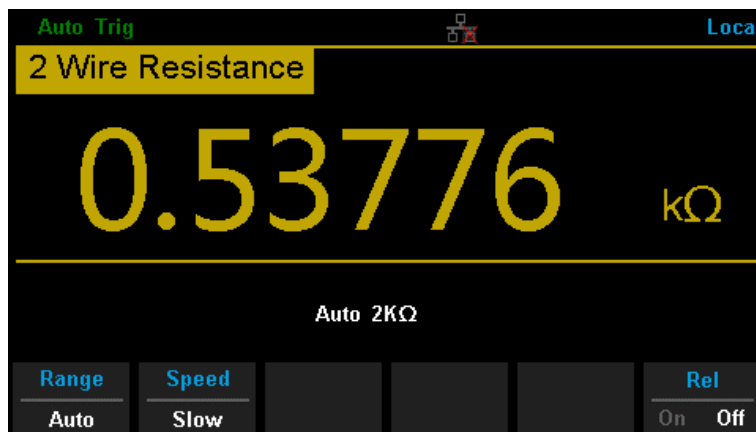

Diagram 3-3 Test Lead Impedance

5. Set parameters for Relative operation.

Press  $\text{Math}$  → [Rel Value] set relative value as current measured value.

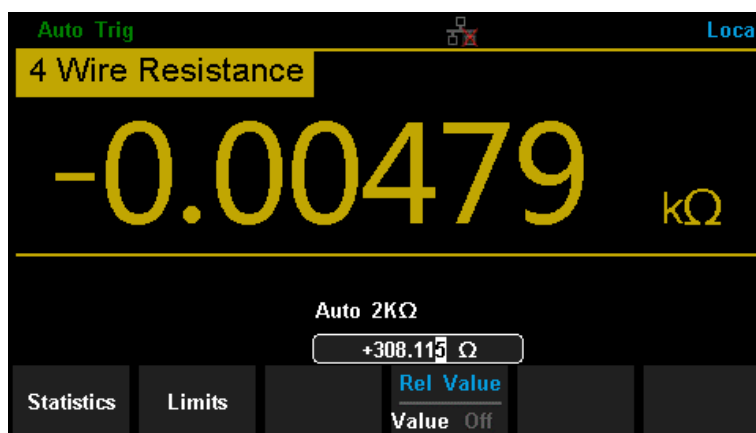

Diagram 3-4 Set Relative Value

6. Besides, pressing [Rel] on the softkey menu could also open Relative operation.



Diagram 3-5 Lead Impedance after Operation

### Example 3: dBm Measurement

dBm is commonly used in audio signal measurement. The following will introduce you how to measure dBm value.

Operating Steps:

1. Press **ACV** on the front panel to select AC Voltage measurement function and choose a proper voltage range.
2. Connect the red lead to terminal Input-HI and black lead to terminal Input-LO as Diagram 2-9.
3. Set the dBm parameters.  
Press **Math** → [Statistics] to turn on the statistics function and set the selective value of dBm as a reference value within supposed circuit by using direction keys: 50Ω.

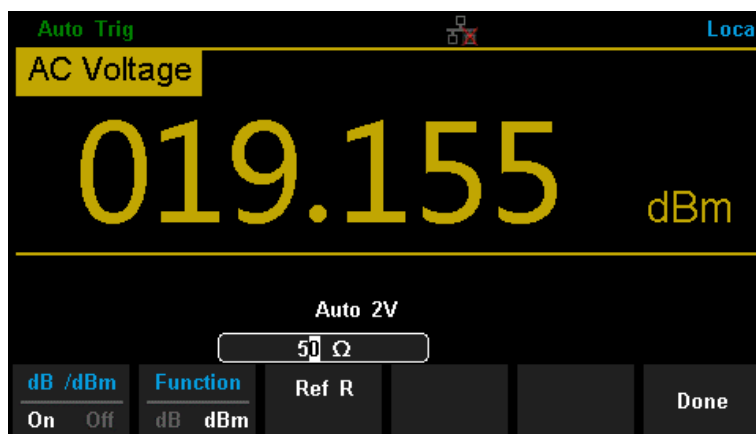

Diagram 3-6 Select Reference Resistance as Measurement Value

4. Press [Done] to return to the higher-level menu. At this time, the reading shown on the screen is the Power value of reference resistance.

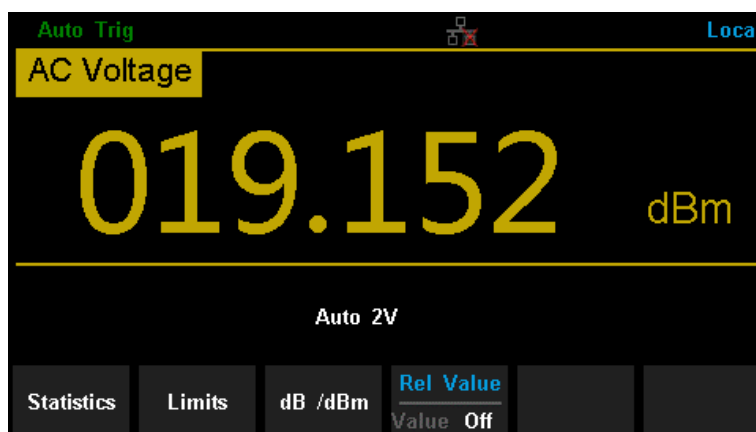

Diagram 3-7 dBm Operation Result



## Example 4: dB Measurement

As a common measuring unit, dB has been widely used in electrical engineering, radio science, mechanics, shock and vibration, mechanical power and acoustics areas. The following will introduce you how to measure dB between two circuits.

Operating Steps:

### Method 1:

Measure dBm1 and dBm2 existing in two circuits separately according to Example 3, and then dB could be got:

$$\text{dB} = \text{dBm1} - \text{dBm2}$$

### Method 2:

1. Press **ACV** on the front panel to select AC Voltage measurement function and choose a proper voltage range.
2. Connect the red lead to terminal Input-HI and black lead to terminal Input-LO as Diagram 2-9.
3. Set up dBm2 according to Example 3.
4. Press **Math** → [dB/dBm] to turn on the dB function and Set parameters of dB operation (dBm1).

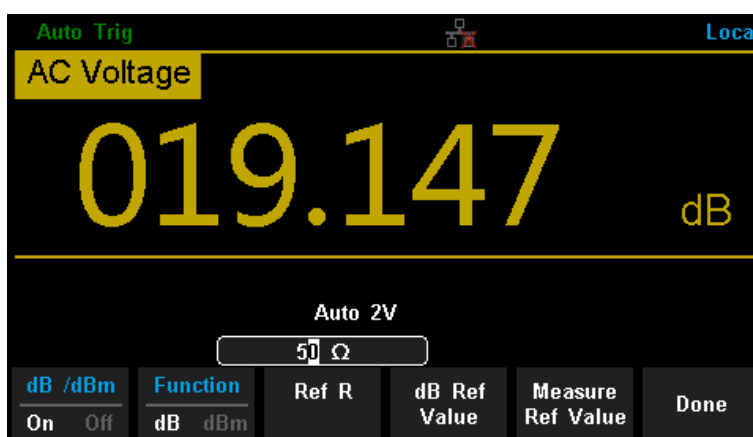

Diagram 3-8 Set the Parameters of dB

5. Press [Done] to return to the higher-level menu. At this time, the reading shown on the screen is the power difference between two circuits.

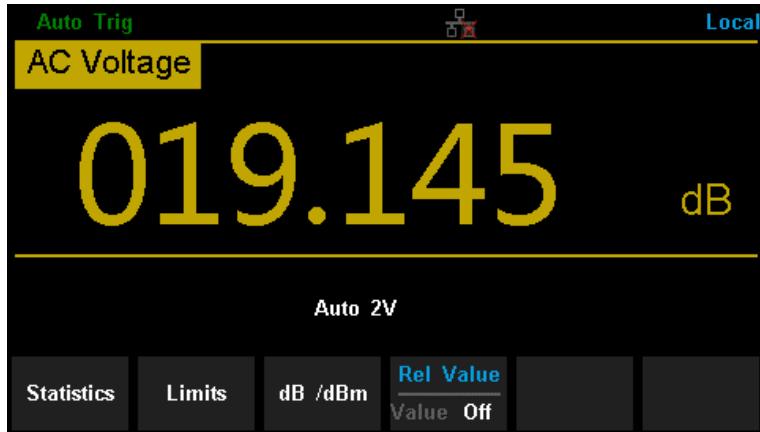

Diagram 3-9 dB Operation Result

## Example 5: Limits Test

Limits Operation hints you the signal is overstep its range according to the selected High and Low Limit parameters; meanwhile the beeper makes a sound to alarm (if sound is on.)

Operating Steps:

1. Press **ACV** on the front panel to select AC Voltage measurement function and choose a proper voltage range.
2. Connect the red lead to terminal Input-HI and black lead to terminal Input-LO as Diagram 2-9.
3. Press **Math** → [Limits] to set the Limits parameters.

Press [Low] to set the low limit value.

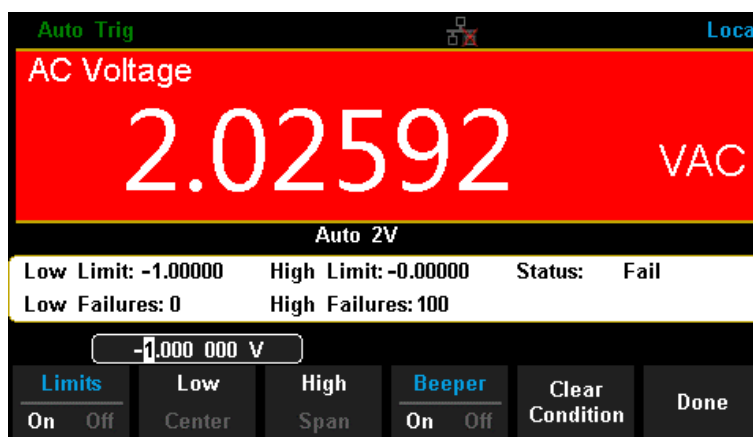

Diagram 3-10 Set the Low Limit Value

Press [High] to set the high limit value.

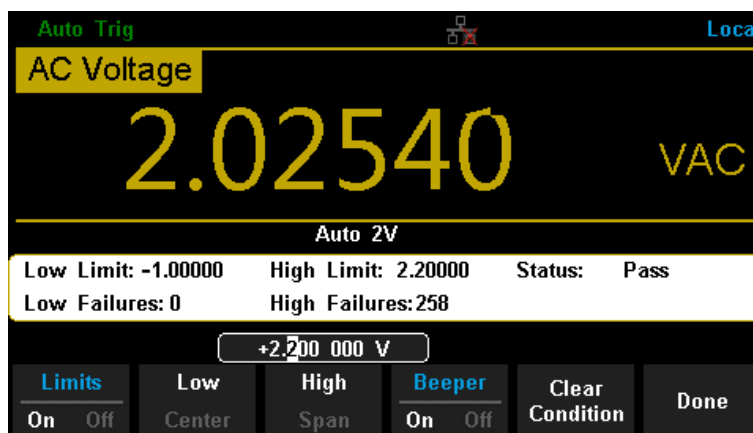

Diagram 3-11 Set the High Limit Value

4. Turn on the beeper and start Limits Test. As shown in Diagram 3-11. The measured result is between the Low and High limits, so the test status is "True".
5. If changing the high limit value to 1V, the measured result is not between the Low and High limits.

So the instrument beep once, and the main display is red. The test status is “Fail” and High Failures is shown. As the following diagram shows.

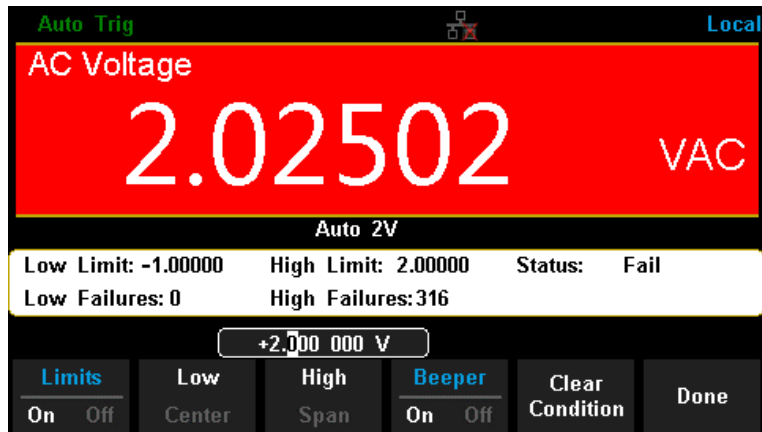

Diagram 3-12 Limits Test Result

## Example 6: Thermocouple setting and measurement

Thermocouple is a common temperature sensor. Type, voltage and cold-side temperature are required for thermocouple measurement.

The instrument can measure temperature of HI and LO terminals (cold-side), and calculate absolute temperature of hot-side. Besides, only the relationship between thermocouple voltage and cold-side temperature is need to be input according thermocouple type when you set the thermocouple sensor.

Operating Steps:

1. Please refer to “To Measure Temperature” in chapter 2 to know about the connection of Sensor.

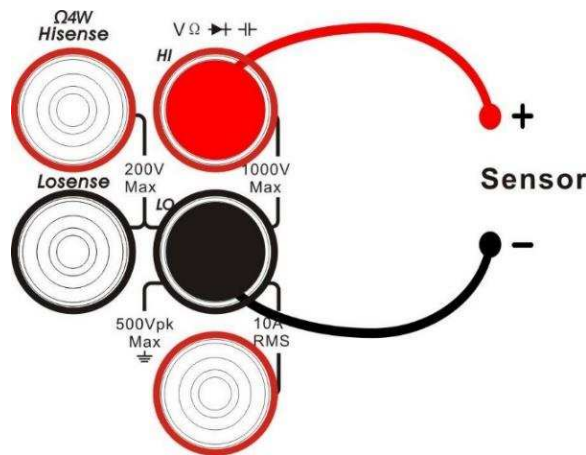

Diagram 3-13 Sketch map for connecting the sensor

2. Select the type of thermocouple.

Press [Load] and choose thermocouple measurement. The Multimeter supports 8 kinds of probe type: B , E , J , K , N , R , S and T.

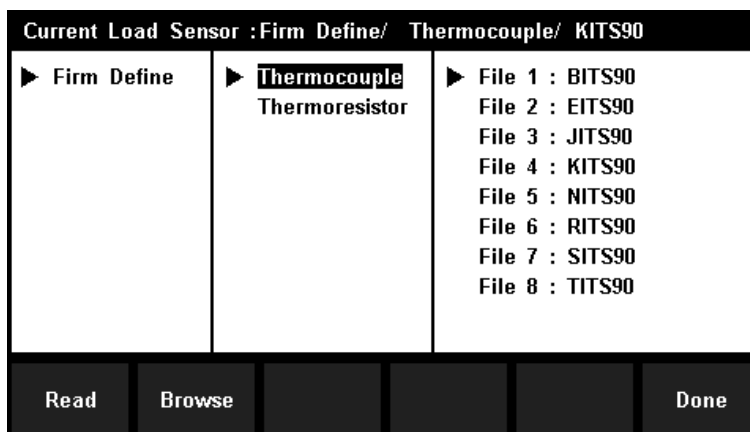

Diagram 3-14 Select the Type of Thermocouple

3. Use direction keys to select corresponding file and press [Read] to recall the sensor settings file.

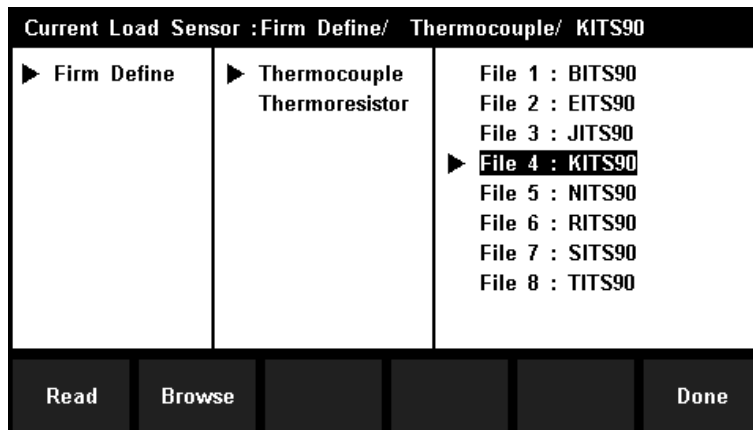

Diagram 3-15 Select Sensor Settings File

4. Press [Units] to choose the unit of temperature.

5. View measured result.

Press [Display] and select display mode of measurement result as "All" to view measurement value and its corresponding value.

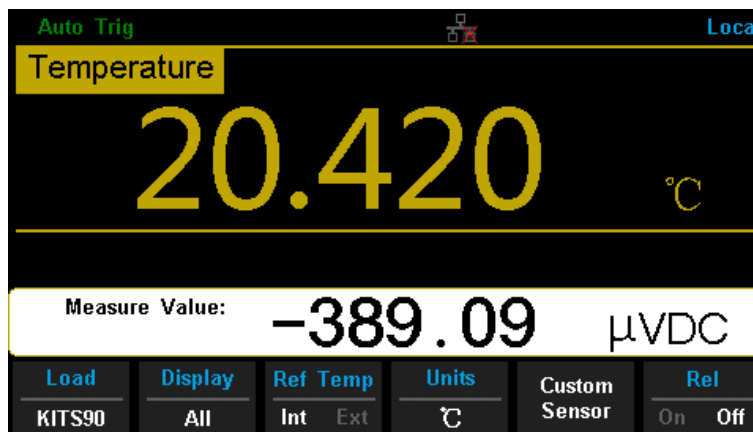

Diagram 3-16 View measured result

## Example 7: To Use Hold Measurement Function

Reading Hold can help user to obtain a stable reading and hold it on the display of Front Panel. The reading would be held all the same although testing pen had been moved away. Then we will introduce how to keep the readings displayed on screen.

Operating Steps:

1. Press **DCV** on the front panel to select DC Voltage measurement function and choose a proper voltage range.
2. Connect the red lead to terminal Input-HI and black lead to terminal Input-LO as Diagram 2-4.
3. Press **Shift** and **Single** to open Hold measurement function interface.

By the time, the screen will record the result of measuring DC voltage, as shown in the following diagram.

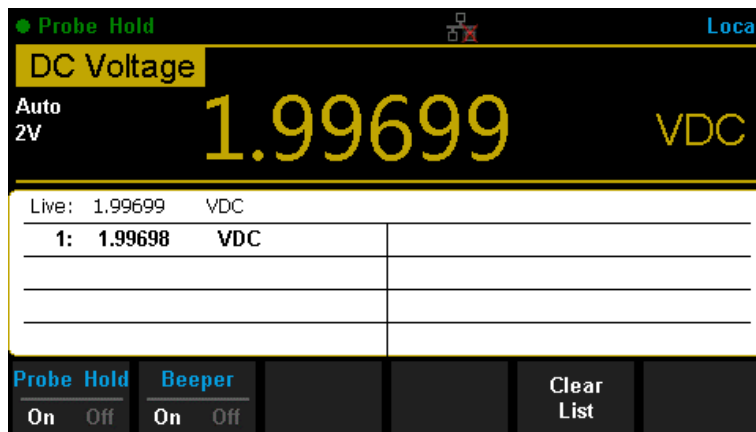

Diagram 3-17 Result 1

4. Press **ACV** on the front panel to select AC Voltage measurement function and choose a proper voltage range.
5. Connect the red lead to terminal Input-HI and black lead to terminal Input-LO as Diagram 2-9. By the time, the screen will record the result of measuring AC voltage, as shown in the following diagram.

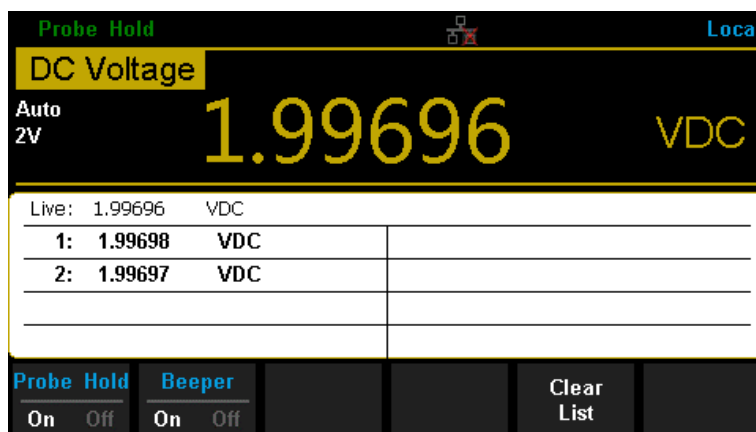

Diagram 3-18 Result 2

## Example 8: To Use Application Software EasySDM

Remote Control function based on EasySDM enables users to operate instrument remotely. The software supports basic measurements, Acquire, Statistics, Trend Chart and Histogram, etc. The method to use the software will be introduced in details as the following steps.

Operating Steps:

1. Connect the Multimeter to your computer by using USB data wire.
2. Open the main interface of EasySDM, click [Control] on the upper left corner and choose [Connect] to contact the instrument with the software. As shown in the following diagram.

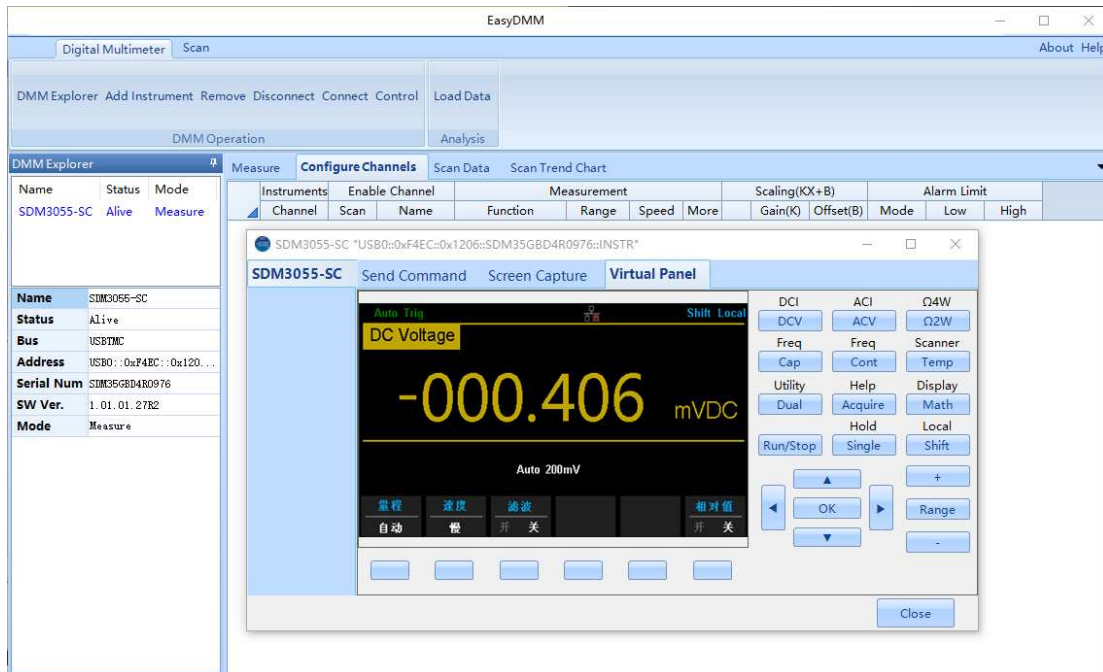

Diagram 3-19 The Main Interface of EasySDM

3. Click any button on the operating interface to do corresponding operating.
4. If you want to exit the remote control, turn off the software, and then press **Shift** on the front panel to close the remote function.



## Chapter 4 Measurement Tutorial

### True RMS AC Measurement

The AC measurement of the Multimeter has true RMS response. The power dissipated in a resistor within a time is proportional to the square of the measured true RMS voltage, independent of wave shape. The instrument can accurately measure true RMS voltage or current, as long as the wave shape contains negligible energy above the effective bandwidth.

The AC voltage and AC current functions measure the “AC coupled” true RMS value, which is to measure the RMS value of the AC component (DC component is rejected) of the input signal. For sine waves, triangle waves, and square waves, the AC and AC+DC values are equal since these waveforms do not contain a DC offset. See the following table 5-1.

Table 4-1 True RMS AC Measurement of Sine, Triangle and Square waves

Waveform	Crest Factor (C.F.)	AC RMS	AC+DC RMS
Sine	$\sqrt{2}$	$\frac{V}{\sqrt{2}}$	$\frac{V}{\sqrt{2}}$
Triangle	$\sqrt{3}$	$\frac{V}{\sqrt{3}}$	$\frac{V}{\sqrt{3}}$
Square	$\sqrt{\frac{T}{t}}$	$\frac{V}{C.F.} \times \sqrt{1 - \left(\frac{1}{C.F.}\right)^2}$	$\frac{V}{C.F.}$

Non-symmetrical waveforms, such as pulse trains, contain DC voltages which are rejected by AC coupled true RMS measurements.

An AC coupled true RMS measurement is desirable in situations where you are measuring small AC signals in the presence of DC offsets. For instance, measuring AC ripple present on DC power supplies. There are situations, however, where you might want to know the AC+DC true RMS value. You can determine this value by combining results from DC and AC measurements as the following shows. You should perform the DC measurement using 5.5-digit mode for best AC rejection.

$$RMS_{(AC+DC)} = \sqrt{AC^2 + DC^2}$$

## Crest Factor Errors (non-sinusoidal inputs)

A common misconception is that "since an ac Multimeter is true RMS, its sine wave accuracy specifications apply to all waveforms." Actually, the shape of the input signal can dramatically affect measurement accuracy. A common way to describe signal wave shapes is "crest factor". Crest factor is the ratio of the peak value to RMS value of a waveform.

Generally speaking, the greater the crest factor, the greater the energy contained in high frequency harmonics. All Multimeters have errors that are crest factor dependent. Crest factor errors of SDM3055 are listed in the **AC Characteristics** section of chapter 6. (The crest factor errors do not apply for input signals below 100Hz.)

You can estimate the measurement error due to signal crest factor as shown below:

Total Error = Error (Sine wave) + Error (Crest factor) + Error (Bandwidth)

Error (Sine wave): error for sine wave as shown in chapter 6.

Error (Crest factor): crest factor additional error as shown in chapter 6.

Error (Bandwidth): estimated bandwidth error as shown below:

$$\text{Bandwidth error} = \frac{-C.F. \times F}{4\pi \times BW} \times 100\% (\% \text{ reading})$$

*C.F.*: signal crest factor

*F*: fundamental frequency of pulse

*BW*: effective bandwidth of the Multimeter

### Example:

Calculate the approximate measurement error for a pulse train input with a crest factor of 2 and a fundamental frequency of 20 kHz. For this example, assume 1-year accuracy specifications of the Multimeter:  $\pm (0.05\% \times \text{reading} + 0.03\% \times \text{range})$ .

$$\begin{aligned} \text{Total Error} &= (0.05\% \times \text{reading} + 0.03\% \times \text{range}) + (0.05\% \times \text{range}) + (0.8\% \times \text{reading}) \\ &= 0.85\% \times \text{reading} + 0.08\% \times \text{range} \end{aligned}$$

## Loading Errors (AC Voltage)

In the AC Voltage function, the input of SDM3055 appears as a 1MΩ resistance in parallel with 100pF of capacitance. The test lead that you use to connect signals to the Multimeter will also add additional capacitance and loading. The approximate input resistances of the Multimeter at different frequencies are listed in the following table.

Table 4-2 Approximate Input Resistances at Different Frequencies

Input Frequency	Input Resistance
100Hz	1MΩ
1kHz	850kΩ
10kHz	160kΩ
100kHz	16kΩ

**For low frequencies:**

$$Error (\%) = \frac{-R_s}{R_s + 1M\Omega} \times 100\%$$

**For high frequencies:**

$$Error (\%) = \left[ \frac{1}{\sqrt{1 + (2\pi \times F \times R_s \times C_m)}} - 1 \right] \times 100\%$$

F: input frequency

Rs: source resistance

Cm: input capacitance (100pF) plus test lead capacitance

## Application of the Analog Filter

The analog filter of the Multimeter can be used to reduce the influence of the AC component in DC measurement. Generally, the filter may not be required, but sometimes it can improve the DC measurement. For example, if the measured DC electrical source has a big AC ripple, the analog filter can reduce the influence.

The analog filter can't be used to filter the internal noise of the instrument. It has no use in DCI opening measurement, DCV short measurement or in measurement of the output from a precise DC calibration instrument. On the contrary, it may lead in additional noise and a bigger reading offset. The Multimeter should be cleared under the selected range and reading rate to decrease the offset when using the analog filter. If you cannot clear the instrument, the measured results will have errors. For other ranges and reading rates, the additional error generated by the filter can be omitted.

Table 4-3 Analog Filter Error in DCV measurement

Range	Reading Rate	Additional Analog Filter Error
200mV	Slow	10 $\mu$ V
	Middle	20 $\mu$ V
	Fast	20 $\mu$ V
2V	Slow	15 $\mu$ V
	Middle	20 $\mu$ V
	Fast	20 $\mu$ V
20V	Slow	0.8mV
	Middle	1mV
	Fast	1mV

Table 4-4 Analog Filter Error in DCI measurement

Range	Reading Rate	Additional Analog Filter Error
200 $\mu$ A	Slow	0.002% range
	Middle	0.005% range
	Fast	0.005% range
20mA, 2A	Slow	0.040% range
	Middle	0.060% range
	Fast	0.080% range
200mA	Slow	0.004% range
	Middle	0.010% range
	Fast	0.010% range
10A	Slow	0.008% range
	Middle	0.010% range
	Fast	0.010% range

## Chapter 5 General Troubleshooting

The following is a list of the troubles that you may meet while using the Multimeter and their solutions. Please handle as the corresponding steps when meeting these troubles. If you still can't handle them, please contact SIGLENT in time.

1. If the screen of the Multimeter is still dark with nothing displaying after pressing the power key:
  - 1) Check if the power has been connected correctly.
  - 2) Check if the main power switch on the back panel has been turned on already.
  - 3) Check if the power fuse has blown. Replace it as desired if it has blown.
  - 4) Restart the Multimeter after all above steps have been done.
  - 5) If the instrument still can't start up properly, please contact SIGLENT.
  
2. The reading doesn't change when connecting an AC current signal:
  - 1) Check if the test lead has been connected to the current jack or LO jack correctly.
  - 2) Check if the fuse in the current location on the back panel has blown.
  - 3) Check if the measuring location has switched to the DCI or ACI place correctly.
  - 4) Check if the input is ACI but the measuring location is in DCI place.
  
3. The reading doesn't change when connecting a DC current signal:
  - 1) Check if the test lead has been connected to the current jack or LO jack correctly.
  - 2) Check if the fuse in the current location on the back panel has blown.
  - 3) Check if the measuring location has switched to the DCI or ACI place correctly.
  - 4) Check if the input is DCI but the measuring location is in ACI place.
  
4. USB Disks can't be recognized by the instrument.
  - 1) Check if the USB disk can work properly.
  - 2) Make sure the used USB disk is of Flash type. The instrument doesn't support USB disks of hard disk type.
  - 3) Check if the capacity of the used USB disk is too large. The Multimeter is recommended not to use USB disks which exceed 4GB.
  - 4) After restarting the instrument, insert the USB disk again to inspect.
  - 5) If you still can't use the USB disk properly, please contact SIGLENT.

## Chapter 6 Appendix

### Appendix A: Accessories

#### Standard Accessories:

- A Power Cord that fits the standard of destination country.
- Two test leads (black and red)
- An USB Cable One backup fuses A Quick Start
- An Application software

#### NOTE:

- We suggest that the length of USB data wire and LAN cable connected to the instrument should be less than 3m to avoid affecting the product performance.
- All the accessories are available by contacting your local SIGLENT office.

## Appendix B: Warranty summary

**SIGLENT** warrants that the products that it manufactures and sells will be free from defects in materials and workmanship for a period of three years from the date of shipment from an authorized **SIGLENT** distributor. If a product proves defective within the respective period, **SIGLENT** will provide repair or replacement as described in the complete warranty statement.

To arrange for service or obtain a copy of the complete warranty statement, please contact your nearest **SIGLENT** sales and service office. Except as provided in this summary or the applicable warranty statement, **SIGLENT** makes no warranty of any kind, express or implied, including without limitation the implied warranties of merchantability and fitness for a particular purpose. In no event shall **SIGLENT** be liable for indirect, special or consequential damages.



## Appendix C: Daily Maintenance and Cleaning

### Maintenance

When storing or placing the instrument, please avoid the liquid crystal display from direct sunlight for a long time.

### NOTE:

To avoid damages to the instrument or probe, please don't place them in mist, liquid or solvent.

### Cleaning

Please often clean the instrument or probe according to the use of them.

- Wipe the external ash of the instrument and probe by a soft rag. Be careful not to scratch the transparent plastic protective screen when cleaning the liquid crystal screen.
- Use a soft rag that has been soaked by water to clean the instrument after cutting off the power. Or use 75% isopropyl alcohol of water solvent to get a more thorough cleaning.

### NOTE:

- To prevent the surface of the instrument or probe from damages, please don't use any corrosive or chemical cleaning reagents.
- Please make sure the instrument is already dry before restarting it to avoid short circuits or personal injuries caused by water.

## Appendix D: Contact SIGLENT

### **SIGLENT TECHNOLOGIES CO., LTD.**

**Address:** 3F, NO.4 building, Antongda Industrial Zone, 3rd Liuxian Road, 68th District, Baoan District, Shenzhen, P.R. China

**Tel:** +86-755-36615186

**Fax:** +86-755-3591582

Post Code: 518101

**E-mail:** [sales@siglent.com](mailto:sales@siglent.com)

<https://www.siglent.com>

### **North America:**

#### **Siglent Technologies NA, Inc**

6557 Cochran Rd Solon, Ohio 44139

**Tel:** 440-398-5800

**Fax:** 440-399-1211

**E-mail:** [info@siglent.com](mailto:info@siglent.com)

**Web:** [www.siglentna.com](http://www.siglentna.com)

### **Europe:**

#### **Siglent Technologies Germany GmbH**

Staetzlinger Str. 70, 86165 Augsburg, Germany

**Tel:** +49(0)-821-666 0 111 0

**Fax:** +49(0)-821-666 0 111 22

**E-mail:** [info-eu@siglent.com](mailto:info-eu@siglent.com)

**Web:** [www.siglenteu.com](http://www.siglenteu.com)



## About SIGLENT

SIGLENT is an international high-tech company, concentrating on R&D, sales, production and services of electronic test & measurement instruments.

SIGLENT first began developing digital oscilloscopes independently in 2002. After more than a decade of continuous development, SIGLENT has extended its product line to include digital oscilloscopes, isolated handheld oscilloscopes, function/arbitrary waveform generators, RF/MW signal generators, spectrum analyzers, vector network analyzers, digital multimeters, DC power supplies, electronic loads and other general purpose test instrumentation. Since its first oscilloscope was launched in 2005, SIGLENT has become the fastest growing manufacturer of digital oscilloscopes. We firmly believe that today SIGLENT is the best value in electronic test & measurement.

### Headquarters:

SIGLENT Technologies Co., Ltd  
Add: Bldg No.4 & No.5, Antongda Industrial  
Zone, 3rd Liuxian Road, Bao'an District,  
Shenzhen, 518101, China  
Tel: + 86 755 3688 7876  
Fax: + 86 755 3359 1582  
Email: sales@siglent.com  
Website: int.siglent.com

### North America:

SIGLENT Technologies America, Inc  
6557 Cochran Rd Solon, Ohio 44139  
Tel: 440-398-5800  
Toll Free: 877-515-5551  
Fax: 440-399-1211  
Email: info@siglentna.com  
Website: www.siglentna.com

### Europe:

SIGLENT Technologies Germany GmbH  
Add: Staetzlinger Str. 70  
86165 Augsburg, Germany  
Tel: +49(0)-821-666 0 111 0  
Fax: +49(0)-821-666 0 111 22  
Email: info-eu@siglent.com  
Website: www.siglenteu.com

Follow us on  
Facebook: SiglentTech

