



HESTORE.HU

elektronikai alkatrész áruház

EN: This Datasheet is presented by the manufacturer.

Please visit our website for pricing and availability at www.hestore.hu.

Potentiometers

CA6
CA9 // CE9
CA14 // CE14
MCA9 // MCE9
MCA14 // MCE14



Carbon
Potentiometers
CA

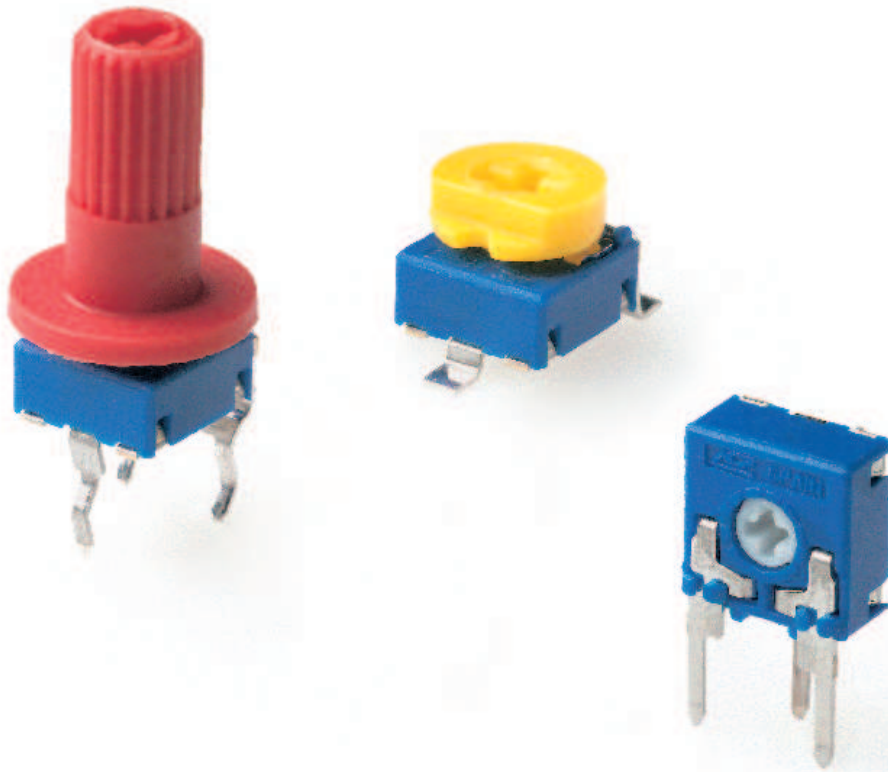

CA6

6mm carbon potentiometers with plastic housing and protection type IP 5 (dust-proof).

CA6 potentiometers are available both in through-hole and in SMD terminal configuration. The substrate in our SMD potentiometers is high temperature resistant, for reflow soldering.

Tapers available include linear, log and antilog, even for SMD potentiometers. ACP can also study special requests.

Terminals are manufactured in tinned brass to guarantee better soldering and higher resistance to corrosion. They can be provided straight or crimped (with “snap in”), which is recommended to hold the potentiometer to the board prior to the soldering operation.

Thumbwheels and shafts can be provided either separately or already inserted in the potentiometer. CA6VSMD potentiometers, with or without thumbwheel, can be requested in Bulk or Tape & Reel (T&R) packaging.

ACP's potentiometers can be adjusted from either side, both in the horizontal and the vertical adjustment types. There is a guide on the housing to simplify the manual adjusting operations.

Our potentiometers can be manufactured in a wide range of possibilities regarding:

- Resistance value.
- Tolerance.
- Tapers / variation laws of the resistive element (linear, log, antilog).
- Others on request.
- Pitch.
- Positioning of the wiper (the standard is at 50%).
- Housing and rotor color.
- Mechanical life.
- Self-extinguishable plastic parts according to UL 94 V-0.

Applications

- Small electronic appliances.
- Measurement and test equipment.
- Automotive: alarms, switches
- Telecommunication equipment (antenna amplifiers and receivers, videocomm., intercomm.)
- Alarm systems.

Models

All models shown here have the standard rotor for the 6mm series, the cross (X). Models can be manufactured with any of the rotors listed on the rotor menu. The color of the housing or rotor can also be modified.

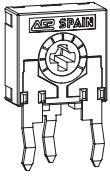

CA6 H2,5

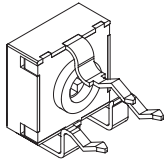

CA6 V 2,5

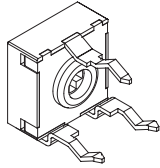

CA6 V5

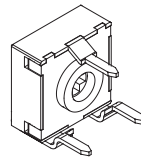

CA6 VS5

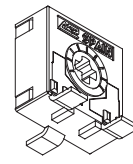

CA6 HSMD

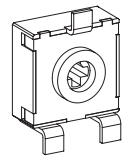

CA6 VSMD

Rotors

The rotor by default is the cross (X). Accessories are designed for the X rotor.

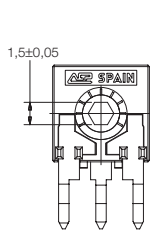

M

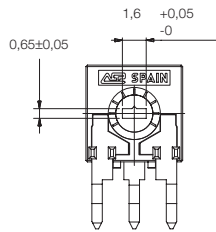

N

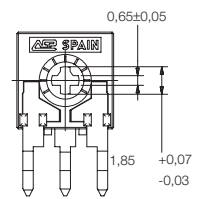

X

Shafts

Shafts are offered in different colors. On request, they can also be provided in accordance with UL 94 V-0. Potentiometers can be supplied with shafts already inserted in. ACP can also study special shafts.

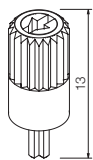

6022

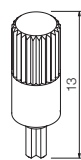

6023

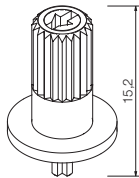

6024

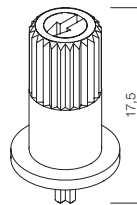

6025

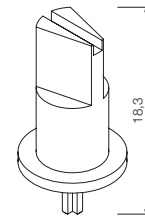

6028

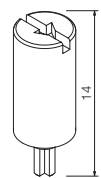

6031

Thumbwheels

Thumbwheels are offered in different colors. On request, they can also be provided in accordance with UL 94 V-0. Potentiometers can be supplied with thumbwheels already inserted in. ACP can also study special thumbwheels.



6001



6030



6032

Terminals

In the CA6 family, ACP will always recommend terminals with “snap in” in order to better hold the component to the board prior to soldering. (Not available for CA6VS5 model).

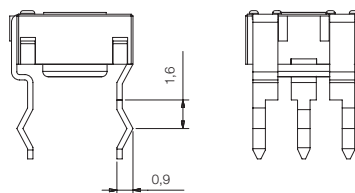

SNP

Adjustment possibilities

ACP's potentiometers can be adjusted through either the front side (WT) or the collector side (WTI):

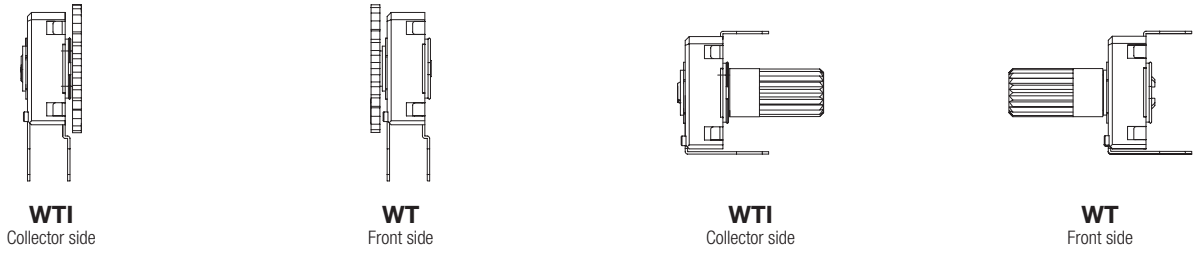

Potentiometers with cut track

The resistive element in this potentiometer has an area with very high resistive values, resulting in an open circuit. Recommended for lighting regulation.

With cut at the beginning of the track CCW: Off-On.

With cut at the end of track- CW: On-Off. Others positions available on request.

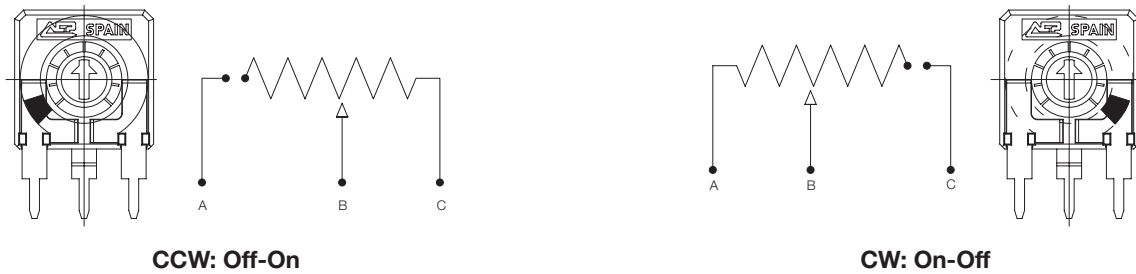

Packaging

Bulk packaging: Potentiometers are first bagged and then introduced in boxes:

Potentiometer model	+ Shaft or thumbwheel inserted	Pieces per box (130 x 60 x 90)
H2,5 - V2,5 - V5 - VS5 - HSMD - VSMD	- (only potentiometers)	1000
	6001, 6030, 6032	1000
	6022, 6023, 6024, 6031	500
	6025, 6028	300

Tape and reel (T&R) packaging:

Potentiometer model	+ Shaft or thumbwheel reference	Pieces per reel
VSMD	- (only potentiometers)	1200
	6030	750

Dimensions: Reel Ø: 330mm, Tape width: 24mm

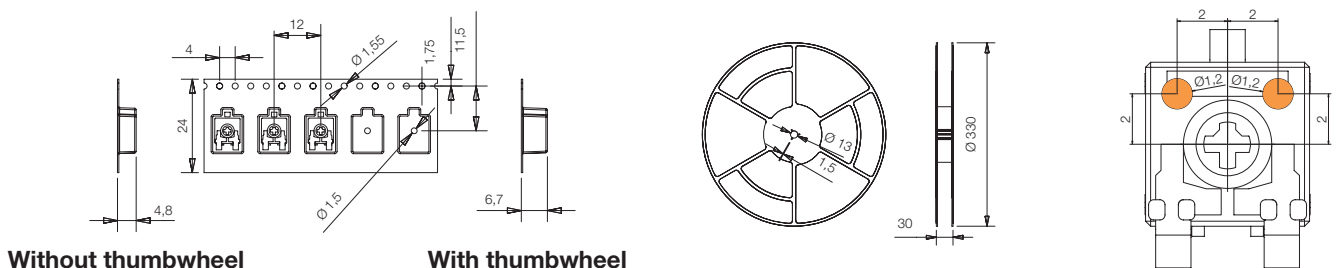

Electric Specifications

These are standard features; other specifications can always be studied on request.

	Through-Hole	SMD
Range of resistance values Lin (A) Log (B) Antilog (C)	100Ω ... 5MΩ 1 KΩ ... 2,2 MΩ	100Ω - 1MΩ 1KΩ - 1MΩ
Tolerance Special tolerances available on request	100Ω ... 1MΩ ±20% >1MΩ ... 5MΩ ±30% Out of range: Rn> 5MΩ: +50% -30%	< 1MΩ ± 25%
Variation laws	Lin (A), Log (B), Antilog (C) Other tapers available on request	
Residual resistance	Lin (A), Log (B), Antilog (C) $\leq 5 \cdot 10^{-3} \cdot R_n$ Minimum value 2Ω	
CRV - Contact Resistance Variation (dynamic)	$\leq 3\% R_n$	
CRV - Contact Resistance Variation (static)	$\leq 5\% R_n$	
Maximum power dissipation at 40° C. Lin (A) No Lin (B, C)	0,10W 0,06W	
Maximum voltage at 40°C Lin (A) No Lin (B, C)	100 VDC 60VDC	
Operating temperature	-25°C ... +70°C	
Temperature coefficient	100Ω - 10KΩ → +200/ -300 ppm. >10KΩ - 5MΩ → +200/ -500 ppm	100Ω - 100KΩ → +200/ -500 ppm. >100KΩ - 1MΩ → +200/ -1000 ppm.

Mechanical Specifications

	Through-Hole and SMD
Resistive element	Carbon technology
Angle of rotation (mechanical)	235° ± 10°
Wiper position	Middle position: 50% ± 15°
Angle of rotation (electrical)	215° ± 20°
Max. stop torque	4 Ncm
Max. push/pull on rotor	9,8 N
Wiper torque	< 2 Ncm
Mechanical life	1000 cycles (more available on request)

Test

Test // Conditions // Typical variation of Nominal Resistance

Damp heat // 500 h. at 40°C and 95% RH // +5%; -2%

Thermal cycles // 16h at 85°C, plus 2h at -25°C // ±2,5%

Load life // 1.000 h. at 40°C // +0%; -5%

Mechanical life // 1000 cycles at 10 c.p.m. and at 23°C ± 2°C // ±3%

Soldering effect // 2 seconds at 350°C // ±1%

Storage (3 years) // at 23°C ± 2°C // ±3%

For further information on tests, go to TESTS AND RELIABILITY, on pages 10-11

CA6 HOW TO ORDER

EXAMPLE: CA6XV2,5-10KA2020 SNP PI WT6030-BA-V0

Standard features								Extra features					Assembled accessory				
Series	Rotor	Model	Packg	Ohm value	Taper	Tol	Life	Track	Terminals	Housing	Rotor	Wiper position	Assembly	Ref #	Color	Flam.	
1	2	3	4	5	6	7	8	9	10	11	12	13	14		15		
CA6	X	V2,5		-10K	A	2020		SNP				PI	WT	6030	-BA	-V0	

Standard configuration		Customized products	
Dimensions:	6mm	A drawing is requested to order a customized product. The code assigned will include all special specifications.	
Protection:	IP 5 (dust proof)		
Resistance:	Carbon technology		
Color:	Blue housing with white rotor		
Packaging:	Bulk		
Wiper position:	at 50% ± 15°		
Terminals:	Snap in P strongly recommended		
Marking:	Resistive value marked on housing; others on request.		
		Series, rotor, model and total resistive value are given before the special code:	
		CA6XV5-10K CODE C00111	

1 - Series

CA6

2 - Rotors

X (Standard)

M

N

3 - Model and pitch

H2,5

V2,5

V5

VS5

HSMD

VSMC

4 - Packaging

Through-hole

SMD models

Bulk -standard-

(blank)...

(blank)...

T&R (Tape and reel)

(N.A.)⁽¹⁾

-T&R

(1) N.A. - Not Available: Tape and Reel packaging is only available for VSMC model.

5 - Resistance value

Through-hole

SMD

Taper:	Lin (A)	Log (B), Antilog (C)	Lin (A)	Log (B), Antilog (C)
Value Rn	100 Ω / 100 .../...	1KΩ / 1K .../...	100Ω / 100 .../...	1KΩ / 1K .../...
	5 MΩ / 5M	2,2 MΩ / 2M2	1 MΩ / 1 MΩ	1 MΩ / 1M

Other resistive values available on request.

6 - Resistance law / taper

Lin - Linear

A

Log - Logarithmic

B

Antilog - Antilogarithmic

C

- Special tapers have codes assigned:

CODE YXXXXX

Please, indicate terminal position when ordering a special taper.

7 - Tolerance

Through-hole models

SMD models

100 Ω ≤ Rn ≤ 1MΩ: ±20% 2020

1 MΩ ≤ Rn ≤ 5MΩ: ±30% 3030

For Rn > 5MΩ, tol : +50% - 30% 5030

2525

Special tolerances available: <5% ... 10%, etc.

8 - Operating life (cycles)

Standard (1000cycles)

(leave blank)

Long life: LV + the number of cycles. ex: LV06 for 6000 cycles⁽¹⁾

LVXX: ex: LV06

(1) Others on request.

9 - Cut track

At beginning of track, CCW: Off - On

PCI

At end of track, CW: On - Off

PCF

10 - Terminals (Crimped terminals or snap in:)

Without SNAP IN-

(leave blank)

With SNAP IN P

SNP

11 - Housing color

Standard is blue

(leave blank)

With other colors -See color chart below-, for example, red CJ-color; ex: CJ-RO

12 - Rotor color

Standard is white

(leave blank)

With other colors -See color chart below-, for example, red RT-color; ex: RT-RO

13 - Wiper position

(Standard: at 50% ± 15°)	(leave blank)
Initial or CCW	PI
Final or CW	PF

14 - Potentiometers with assembled accessories

Assembled from front side	WT
Assembled from collector side	WTI
Accessory Reference See list of shafts and thumbwheels available	XXXX Example: 6030
Color of shaft or thumbwheel	-YY Example, white: -BA

15 - Flammability (according to UL 94 V-0)

Not self-extinguishable	(leave blank)
Self-extinguishable (including all plastic parts of the potentiometers: rotor, housing and accessory. If only one part needs to be V0, please, inform)	-V0

For ordering spare accessories

Accessory reference - color- flammability. Ex. 6030-BA-V0 is a white self-extinguishable 6030 thumbwheel XXXX-YY-__

Color chart for rotor, housing and accessories

Black ⁽¹⁾	NE
White	BA
Neutral	IN
Transparent	TA
Red	RO
Green	VE
Yellow	AM
Blue	AZ
Grey	GS
Brown	MR

(1) Black is not available for housings.

Specifications on this catalogue are for reference only; they are subject to change without notice.



CA9



CE9

Carbon
Potentiometers
CA

Cermet
Potentiometers
CE

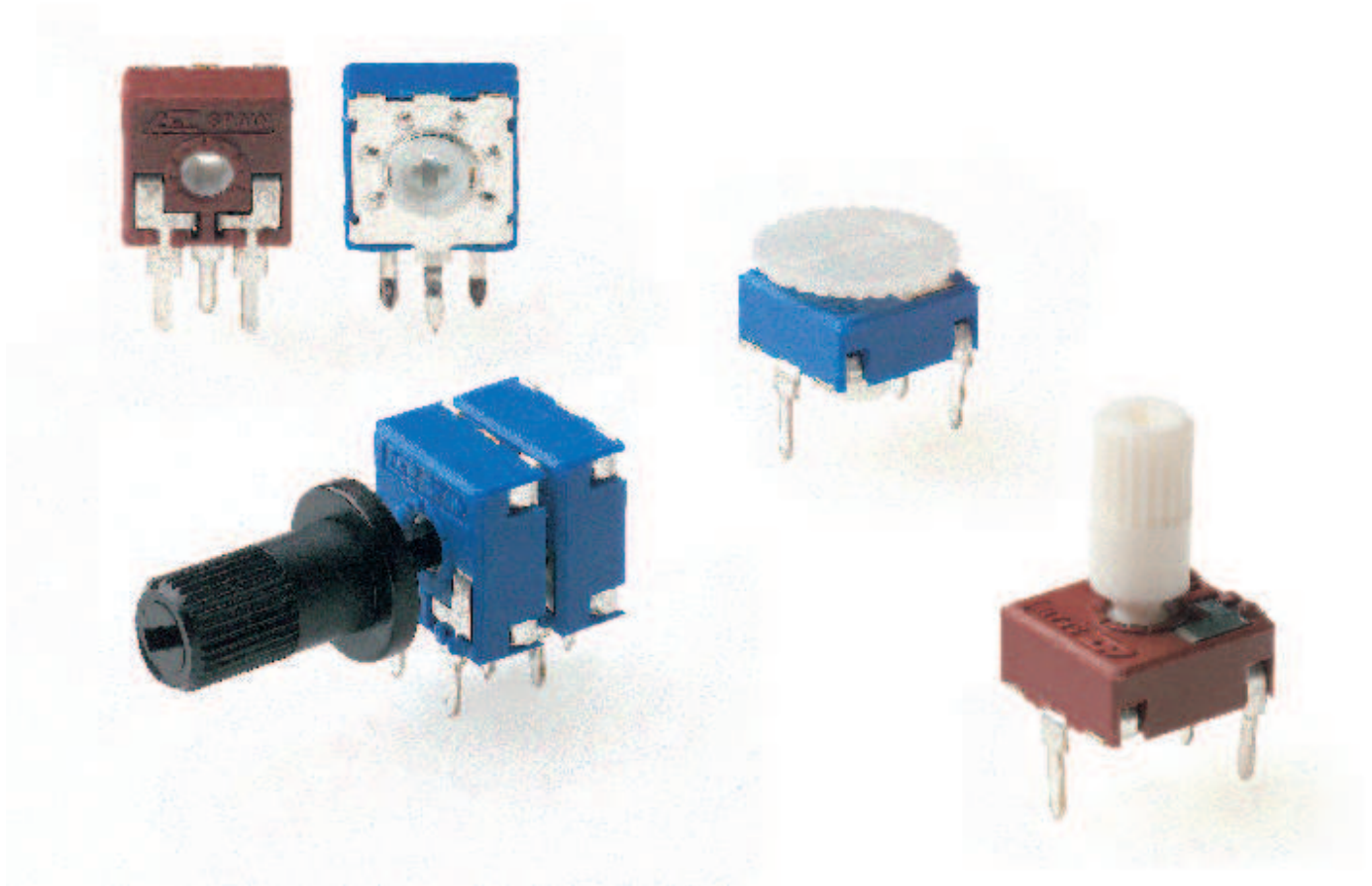



9mm carbon potentiometers with plastic housing and protection type IP 5 (dust-proof).

Standard tapers available include linear, log and antilog. ACP can also study special requests.

Terminals are manufactured in tinned brass to guarantee better soldering and higher resistance to corrosion. They can be provided straight or crimped (with “snap in”), recommended to hold the potentiometer to the board prior to the soldering operation. SMD configuration can be available on request.

Thumbwheels and shafts can be provided either separately or already inserted in the potentiometer.

ACP's potentiometers can be adjusted from either side, both in the horizontal and the vertical adjustment types. There is a guide on the housing to simplify the manual adjusting operations.

Our potentiometers can be manufactured in a wide range of possibilities regarding:

- Resistance value.
- Tolerance.
- Tapers / variation laws.
- Pitch.
- Positioning of the wiper (the standard is at 50%).
- Housing and rotor color.
- Mechanical life.
- Pause effect (up to 20 detents available).
- Self-extinguishable plastic parts according to UL 94 V-0.

Applications

- Electronic appliances: white goods, brown goods, small household appliances.
- Heating and air conditioning equipment and thermostats.
- Automotive: dimmers, climate controls, lighting regulation (position adjustment and sensing).
- Measurement and test equipment. Timers and relays.
- Multimedia.



9mm Cermet potentiometers with plastic housing and protection type IP 5 (dust-proof). Self-extinguishable according to UL 94 V-0.

Standard taper is linear. Log, Antilog and other tapers are available on request. Laser trimming equipment in-house, allowing for very low tolerances.

Terminals are manufactured in tinned brass to guarantee better soldering and higher resistance to corrosion. They can be provided straight or crimped (with “snap in”), recommended to hold the potentiometer to the board prior to the soldering operation. SMD configuration can be available on request.

Thumbwheels and shafts can be provided either separately or already inserted in the potentiometer.

ACP's potentiometers can be adjusted from either side, both in the horizontal and the vertical adjustment types. There is a guide on the housing to simplify the manual adjusting operations.

Our potentiometers can be manufactured in a wide range of possibilities regarding:

- Resistance value.
- Tolerance.
- Tapers / variation laws.
- Pitch.
- Positioning of the wiper (the standard is at 50%).
- Housing and rotor color.
- Mechanical life.
- Pause effect (up to 20 detents available).

Applications

- Electronic appliances: white goods, brown goods, small household appliances, boilers, water heaters, etc.
- Heating and air conditioning equipment and thermostats.
- Automotive: dimmers, climate controls, lighting sensors.
- Industrial electronics: multimeters, oscilloscopes, test equipment, time relay.

Models

All models shown here have the standard rotor for the 9mm series, the arrow (P). Models can be manufactured with any of the rotors listed on the rotor menu. The color of the housing or rotor can also be modified. SMD configuration can be available on request.

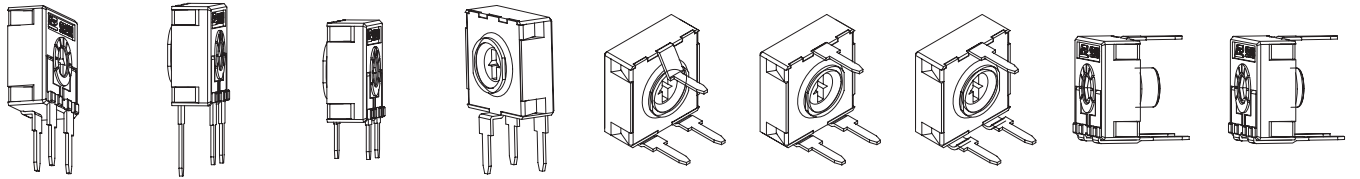

CA9 H2,5 CE9 H2,5 CA9 H3,8 CE9 H3,8 CA9 HS3,8 CE9 HS3,8 CA9 H5 CE9 H5 CA9 V7,5 CE9 V7,5 CA9 V10 CE9 V10 CA9 VR10 CE9 VR10 CA9 MAV10 CE9 MAV10 CA9 MTV10 CE9 MTV10

Rotors

The rotor by default is the arrow (P). Accessories are designed for the M and J rotors, unless otherwise stated.

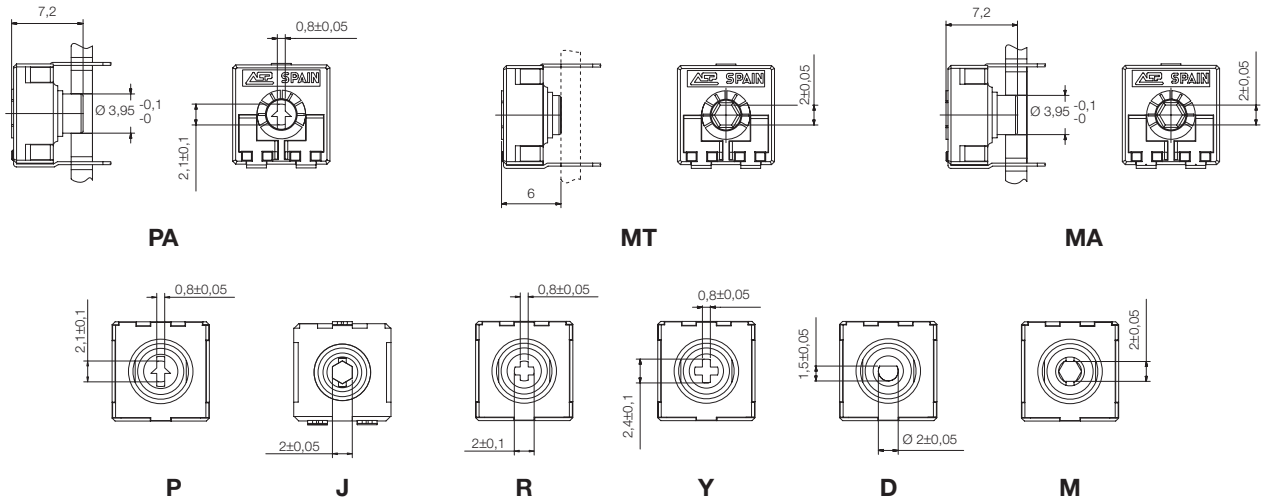

Shafts

• **CA9.** Shafts are available in different colors. On request, they can also be provided in accordance with UL 94 V-0. Potentiometers can be supplied with shafts already inserted in. ACP can also study special shafts.

• **CE9.** Shafts in accordance with UL 94 V-0 are available in different colors. Potentiometers can be supplied with shafts already inserted in. ACP can also study special shafts.

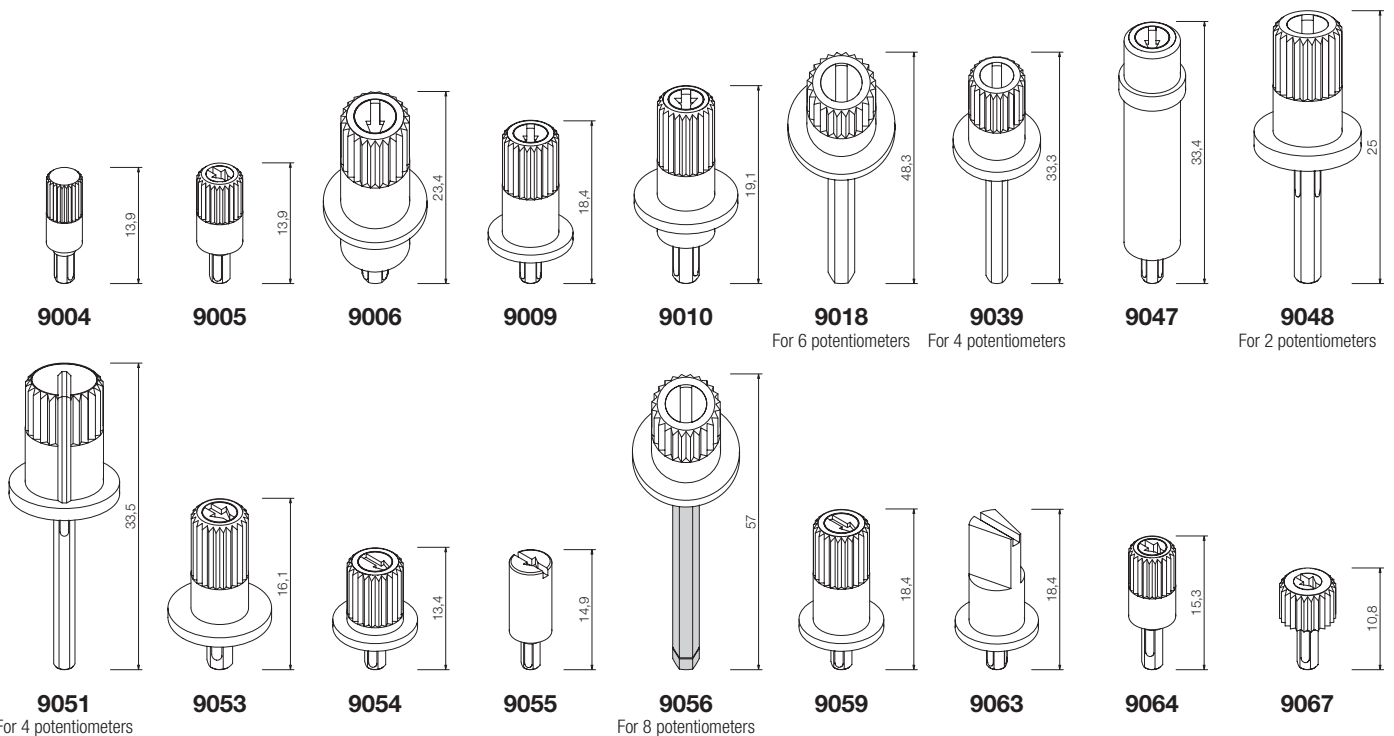

Thumbwheels

• **CA9.** Thumbwheels are available in different colors. On request, they can also be provided in accordance with UL 94 V-0. Potentiometers can be supplied with thumbwheels already inserted in. ACP can also study special requests for thumbwheels.

• **CE9.** Thumbwheels in accordance with UL 94 V-0 are available in different colors. Potentiometers can be supplied with thumbwheels already inserted in. ACP can also study special requests for thumbwheels.

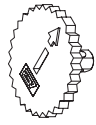

9002

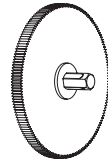

9041

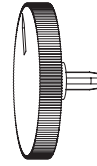

9060
For R rotor

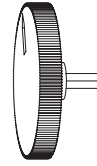

9061

Terminals

By default, terminals are always straight for the 9mm size, as shown on the “models” menu. ACP can provide crimped terminals (with “snap in”), to better hold the component to the board prior to soldering.

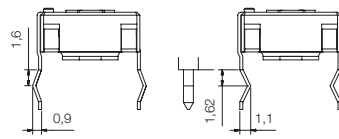

SNP

SNJ

Adjustment possibilities

ACP's potentiometers can be adjusted through either the front side (WT) or the collector side (WTI):

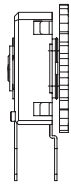

WTI
Collector side

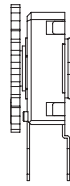

WT
Front side

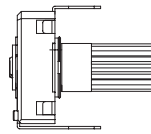

WTI
Collector side

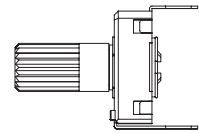

WT
Front side

Potentiometers with detents

ACP's “detent” feature (DT) is specially suitable for control applications. Our patented design has improved the features of these potentiometers:

- Longer mechanical life: up to 10.000 cycles.
- More stable electrical parameters.
- Improved reliability and Contact Resistance Variation (CRV).
- Narrower tolerances for detent positioning.

Detents can be lighter or stronger, or even a combination of both feelings. Detents can be evenly distributed along the angle (standard), or tailored to match customers' request. They can also be combined with special tapers: constant value areas, different slopes, etc.

Examples: 4, 6 and 20 detents –evenly distributed–.

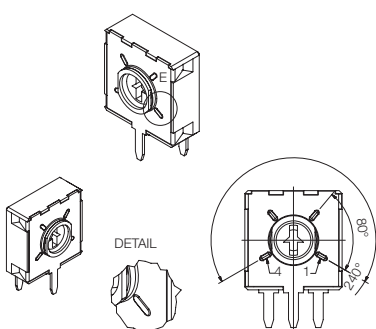

4DT

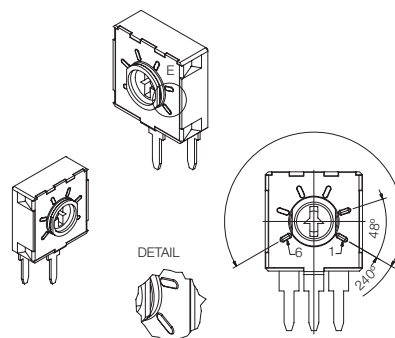

6DT

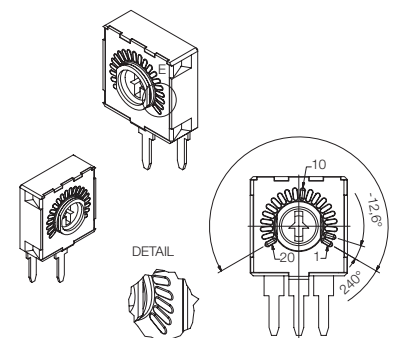

20DT

Potentiometers with cut track

The resistive element in this potentiometer has an area with very high resistive values, resulting in an open circuit. Recommended for lighting regulation.

With cut at the beginning of the track CCW: Off-On.

With cut at the end of track CW: On-Off. Other positions available on request.

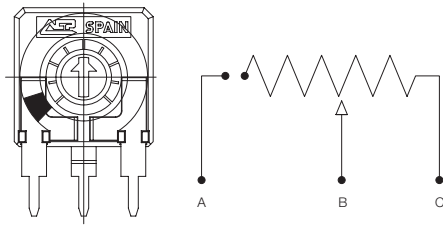

CCW: Off-On

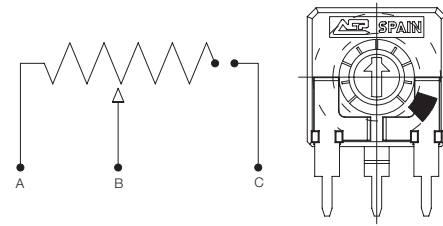

CW: On-Off

Assemblies of several potentiometers

STACKING: Set of 6 potentiometers in a plastic cover. It is used to speed up assembly and soldering process.

GANGED: Set of potentiometers in a row that allows for simultaneous adjustment of all of them through one shaft. Recommended potentiometer model is H2,5. MTX2 (2 potentiometers), MTX4 (4), MTX6 (6), MTX8 (8).

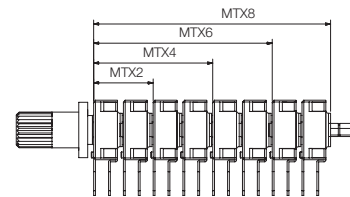
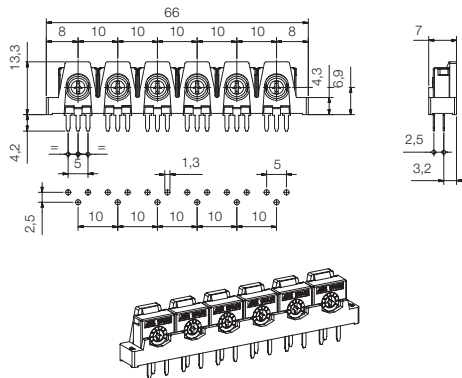

Packaging

Bulk packaging: Potentiometers are first bagged and then introduced in boxes:

Potentiometer model	+ Shaft or thumbwheel inserted	Pieces per box (130 x 60 x 90)
	- (only potentiometers)	500 (models with * : 450)
H2,5 - H3,8 - H5 - HS3,8 - V7,5 - V10 - VR10 MAV10* - MTV10*	9002	250
	9004, 9005, 9006, 9009, 9010, 9018, 9039, 9041, 9047, 9048, 9051, 9056, 9059, 9053, 9054, 9055, 9060, 9061, 9063, 9064, 9067	200
MTX2	9048	150
MTX4	9039, 9051	75
MTX6	9018	50
MTX8	9056	40
STACKING	-	50

Tape and reel (T&R) packaging will be available for SMD configurations, on request.



CA9. Electric Specifications

These are standard features; other specifications can always be studied on request.

Range of resistance values Lin (A) Log (B) Antilog (C)	$100\Omega \leq R_n \leq 5M\Omega$ 1 K Ω ... 2,2 M Ω
Tolerance Special tolerances available on request	100 Ω ... 1M Ω $\pm 20\%$ >1M Ω ... 5M Ω $\pm 30\%$ Out of range: R _n > 5M Ω : +50%, -30%
Variation laws	Lin (A), Log (B), Antilog (C) Other tapers available on request
Residual resistance	Lin (A), Log (B), Antilog (C) $\leq 5 \cdot 10^{-3} R_n$ Minimum value 2 Ω
CRV - Contact Resistance Variation (dynamic)	$\leq 3\% R_n$
CRV - Contact Resistance Variation (static)	$\leq 5\% R_n$
Maximum power dissipation at 40° C. Lin (A) Non Lin (B, C)	0,15W 0,10W
Maximum voltage at 40° C Lin (A) Non Lin (B, C)	200VDC 150VDC
Operating temperature	-25°C ... +70°C
Temperature coefficient	100 Ω - 10K Ω \rightarrow +200/ -300 ppm. >10K Ω - 5M Ω \rightarrow +200/ -500 ppm



CA9. Mechanical Specifications

Resistive element	Carbon technology
Angle of rotation (mechanical)	240° \pm 5°
Wiper position	Middle position: 50% \pm 15°
Angle of rotation (electrical)	220° \pm 20°
Max. stop torque	5 Ncm
Max. push/pull on rotor	40 N
Wiper torque	< 2 Ncm (0,4 ... 3,5Ncm for pots. with detents)
Mechanical life	1000 cycles (more available on request) (up to 10.000 cycles for pots. with detents)



CA9. Test

Test // Conditions // Typical variation of Nominal Resistance

Damp heat // 500 h. at 40°C and 95% RH // +5%; -2%
Thermal cycles // 16h at 85°C, plus 2h at -25°C // $\pm 2,5\%$
Load life // 1.000 h. at 40°C // +0%; -5%
Mechanical life // 1000 cycles at 10 c.p.m. and at 23°C \pm 2°C // $\pm 3\%$
Soldering effect // 2 seconds at 350°C // $\pm 1\%$
Storage (3 years) // at 23°C \pm 2°C // $\pm 3\%$
For further information on tests, go to TESTS AND RELIABILITY on pages 10-11.

All specifications are given at 23°C \pm 2°C and 50% \pm 25% RH.



CE9. Electric Specifications

These are standard features; other specifications can always be studied on request.

Range of resistance values Lin (A) Log (B) Antilog (C)	$100\Omega \leq R_n \leq 5M\Omega$ 1 K Ω ... 2,2 M Ω
Tolerance Special tolerances available on request	100 Ω ... 1M Ω $\pm 20\%$ >1M Ω ... 5M Ω $\pm 30\%$ Out of range: R _n > 5M Ω : +50%, -30%
Variation laws	Lin (A) Log (B), Antilog (C) and other tapers available on request
Residual resistance	Lin (A), Log (B), Antilog (C) $\leq 5 \cdot 10^{-3} R_n$ Minimum value 2 Ω
CRV - Contact Resistance Variation (dynamic)	$\leq 3\% R_n$
CRV - Contact Resistance Variation (static)	$\leq 5\% R_n$
Maximum power dissipation at 40° C. Lin (A) Non Lin (B, C)	0,5W See note 1
Maximum voltage at 40° C Lin (A) Non Lin (B, C)	200VDC See note 1
Operating temperature	-40°C ... +125°C
Temperature coefficient	± 100 ppm.

Note 1: Value depends on taper, please, inquire.



CE9. Mechanical Specifications

Resistive element	Cermet technology
Angle of rotation (mechanical)	240° \pm 5°
Wiper position	Middle position: 50% \pm 15°
Angle of rotation (electrical)	220° \pm 20°
Max. stop torque	5 Ncm
Max. push/pull on rotor	40 N
Wiper torque	< 2 Ncm (0,4 ... 3,5Ncm for pots. with detents)
Mechanical life	1000 cycles (more available on request) (up to 10.000 cycles for pots. with detents)



CE9. Test

Test // Conditions // Typical variation of Nominal Resistance

Damp heat // 500 h. at 40°C and 95% RH // $\pm 2\%$
Thermal cycles // 16h at 90°C, plus 2h at -40°C // $\pm 2\%$
Load life // 1.000 h. at 70°C // $\pm 2\%$
Mechanical life // 1000 cycles at 10 c.p.m. and at 23°C \pm 2°C // $\pm 2\%$
Soldering effect // 2 seconds at 350°C // $\pm 1\%$
Storage (3 years) // at 23°C \pm 2°C // $\pm 3\%$
For further information on tests, go to TESTS AND RELIABILITY on pages 10-11.

- **EXAMPLE: CA9MH2,5-10KA2020 SNP PI WT9005-BA-V0**
- **EXAMPLE: CE9MH2,5-10KA2020 SNP PI WT9005-BA-V0**

Standard features								Extra features							Assembled accessory			
Series	Rotor	Model	Packg	Ohm value	Taper	Tol	Life	Track	Detents	Snap in	Housing	Rotor	Wiper	Lin	Assembly	Ref #	Color	Flam.
1	2	3	4	5	6	7	8	9	10	11	12	13	14	15		16		17
CA9/CE9	M	H2,5		-10K	A	2020				SNP			PI		WT	9005	-BA	-V0

Standard configuration		Customized products	
Dimensions:	9mm	A drawing is requested to order a customized product. The code assigned will include all special specifications.	
Protection:	<ul style="list-style-type: none"> • CA9: IP 5 (dust-proof) • CE9: IP-5 (dust-proof) Self-extinguishable, to meet UL 94 V-0 		
Substrate:	<ul style="list-style-type: none"> • CA9: Carbon technology • CE9: Cermet 	Series, rotor, model and total resistive value are given before the special code: CA9PH2,5 10K CODE C00111.	
Color:	<ul style="list-style-type: none"> • CA9: Blue housing with white rotor • CE9: Brown housing with white rotor 		
Packaging:	Bulk		
Wiper position:	at 50% ±15°		
Terminals:	Straight, without SNAP IN		
Marking:	Resistive value marked on housing. Others on request		

1 - Series

- CA9
- CE9

3 - Model and pitch

H2,5	H3,8	H5	HS3,8	V7,5
V10	VR10	MAV10	MTV10	

HSMD and VSMD models can be available on request.

5 - Resistance value

Taper:	Lin (A)	Log (B), Antilog (C)
Value Rn	100 Ω / 100 ... / ... 5 MΩ / 5M	1KΩ / 1K ... / ... 2,2 MΩ / 2M2

Other resistive values available on request.

7 - Tolerance

100 Ω ≤ Rn ≤ 1MΩ: ±20%	2020
1 MΩ ≤ Rn ≤ 5MΩ: ±30%	3030
For out of range values: Rn > 5MΩ, tol : +50% - 30%	5030

Special tolerances available: <5% ... 10%, etc.

9 - Cut track

At beginning of track, CCW: Off - On	PCI
At end of track, CW: On - Off	PCF

11 - Crimped terminals (SNAP IN)

SNAP IN P	SNP
SNAP IN J	SNJ

2 - Rotors

P (standard)	PA	R	Y	D	M	MA	MT	J
--------------	----	---	---	---	---	----	----	---

4 - Packaging

	Through-hole	SMD models
Bulk	(blank)... ⁽¹⁾	On request
T&R (Tape and reel)	(N.A.) ⁽²⁾	On request

(1) If blank, bulk packaging is implied.

(2) N.A. - Not Available: Tape and Reel packaging is only available for SMD terminals.

6 - Resistance law / taper

Lin - Linear	A
Log - Logarithmic	B (on request for CE)
Antilog - Antilogarithmic	C (on request for CE)
- Special tapers have codes assigned:	CODE YXXXXX

Please, indicate terminal position when ordering a special taper.

8 - Operating life (cycles)

Standard (1000cycles)	(leave blank)
Long life: LV + the number of cycles. ex: LV10 for 10000 cycles ⁽¹⁾	LVXX: ex: LV10

(1) Others on request.

10 - Detents (DT)

One detent at the beginning: CCW	DTI
One detent at the end: CW	DTF
X number of detents. Ex., 10	XDT: 10DT

Detents readily available: 3, 4, 6, 7, 9, 10, up to 20 –evenly distributed along 240°±5°. Others on request.

12 - Housing color

- **CA9:** standard is blue
- **CE9:** standard is brown

With other colors -see color chart below-, for example, red CJ-color, ex: CJ-R0

13 - Rotor color

Standard is white	
With other colors -see color chart below-, for example, red	RT-color; ex: RT-RO

15 - Linearity

Independent linearity controlled & below x%, for example, 3%: LN3%	LNx%; ex: LN3%
Absolute linearity controlled & below x%	LAx%

17 - Flammability (according to UL 94 V-0)

• CA9: Not self-extinguishable	(leave blank)
Self-extinguishable according to standard UL 94 (including all plastic parts of the potentiometer: rotor, housing and accessory. If only one part needs to be V0, please, inform)	-V0
• CE9: All accessories assembled with cermet potentiometers will have the self-extinguishable property according to standard UL 94	-V0

For ordering spare accessories

Accessory reference - color- flammability. Ex. 9005-AZ-V0 is a blue self-extinguishable 9005 thumbwheel XXXX-YY-__

For ordering special sets of potentiometers

STACKING STK + ... (POTENTIOMETER CODE) Example: STK+CA9MH2,5-10KA2020 ⁽¹⁾

GANGED MTX + (number of potentiometers: 2, 4, 6, 8) + ... (POT. CODE + ASSEMBLED SHAFT CODE) Example: MTX4+CA9PH2,5-10KA2020 WT9051-BA ⁽¹⁾

(1) Note: If not all potentiometers in the set are identical, please, order potentiometers separately and indicate assembly order.

Color chart for rotor, housing and accessories

Black ⁽¹⁾	NE
White	BA
Neutral	IN
Transparent	TA
Red	RO
Green	VE
Yellow	AM
Blue	AZ
Grey	GS
Brown	MR

(1) Black is not an option for housings.

14 - Wiper

Wiper position (Standard is at 50% ± 15°)	(leave blank)
Initial or CCW	PI
Final or CW	PF
Others: following clock positions; at 3hours: P3H	PXH, ex: P3H
Wiper torque (Standard: <2 Ncm)	(leave blank)
Low torque (< 1.5Ncm)	PGB

16 - Potentiometers with assembled accessories

Assembled from front side	WT
Assembled from collector side	WTI
Accessory Reference See list of shafts and thumbwheels available	XXXX Example: 9005
Color of shaft or thumbwheel	-YY Example, white: BA

Specifications on this catalogue are for reference only; they are subject to change without notice.

 CA14  CE14

Carbon
Potentiometers
CA

Cermet
Potentiometers
CE

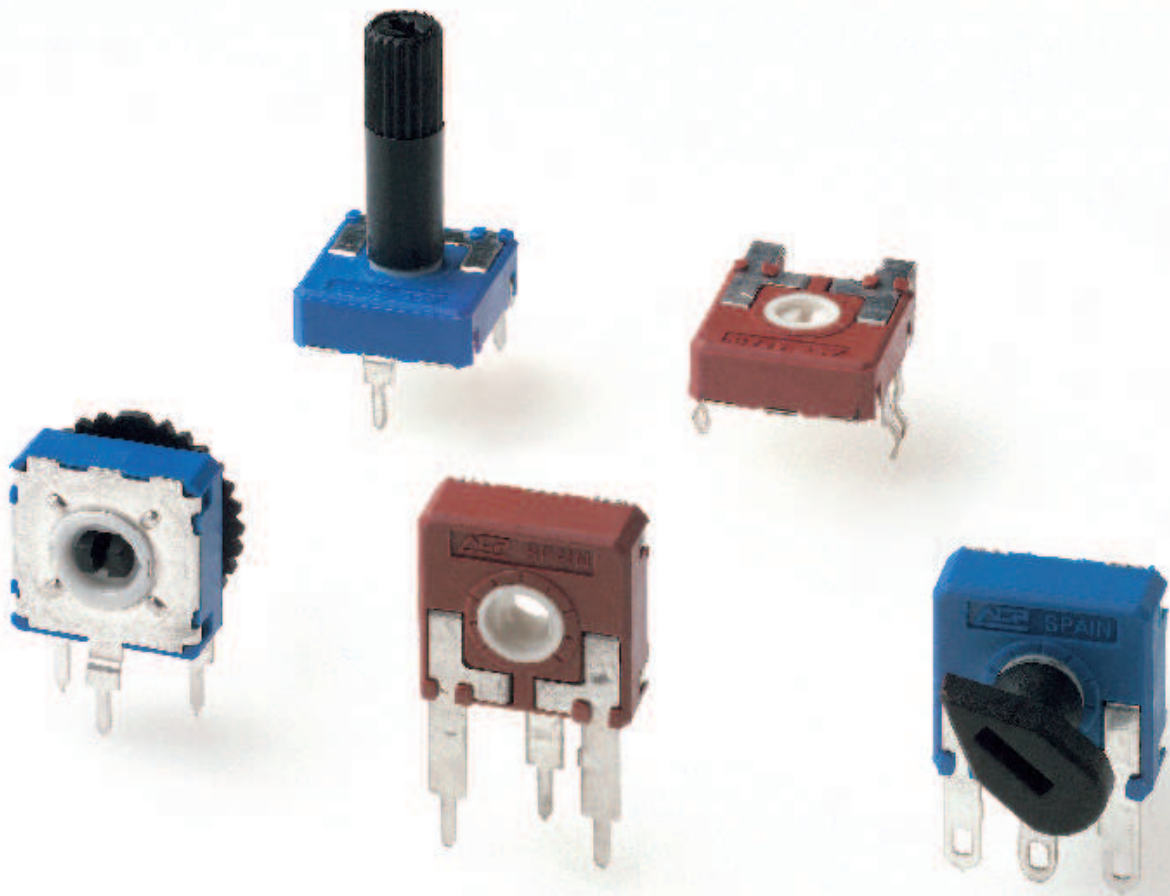

CA14

14mm carbon potentiometers with plastic housing and protection type IP 5 (dust-proof).

Standard tapers available include linear, log and antilog. ACP can also study special requests.

Terminals are manufactured in tinned brass to guarantee better soldering and higher resistance to corrosion. They can be provided straight or crimped (with “snap in”), recommended to hold the potentiometer to the board prior to the soldering operation. SMD configuration can be available on request.

Thumbwheels and shafts can be provided either separately or already inserted in the potentiometer.

ACP's potentiometers can be adjusted from either side, both in the horizontal and the vertical adjustment types. There is a guide on the housing to simplify the manual adjusting operations.

Our potentiometers can be manufactured in a wide range of possibilities regarding:

- Resistance value.
- Tolerance.
- Tapers / variation laws.
- Pitch.
- Positioning of the wiper (standard is at 50%).
- Housing and rotor color.
- Mechanical life.
- Pause effect (up to 38 detents available).
- Self-extinguishable plastic parts according to UL 94 V-0.

Applications

- Electronic appliances: white goods, brown goods, small household appliances
- Heating and air conditioning equipment and thermostats.
- Automotive: dimmers, climate controls, lighting regulation (position adjustment and sensing).
- Measurement and test equipment.

CE14

14mm cermet potentiometers with plastic housing and protection type IP 5 (dust-proof). Self-extinguishable according to UL 94 V-0.

Standard taper is linear. Log, Antilog and other tapers are available on request. Laser trimming equipment in-house, allowing for very low tolerances.

Terminals are manufactured in tinned brass to guarantee better soldering and higher resistance to corrosion. They can be provided straight or crimped (with “snap in”), recommended to hold the potentiometer to the board prior to the soldering operation. SMD configuration can be available on request.

Thumbwheels and shafts can be provided either separately or already inserted in the potentiometer.

ACP's potentiometers can be adjusted from either side, both in the horizontal and the vertical adjustment types. There is a guide on the housing to simplify the manual adjusting operations.

Our potentiometers can be manufactured in a wide range of possibilities regarding:

- Resistance value.
- Tolerance.
- Tapers / variation laws.
- Pitch.
- Positioning of the wiper (the standard is at 50%).
- Housing and rotor color.
- Mechanical life.
- Pause effect (up to 38 detents available).

Applications

- Electronic appliances: white goods, brown goods, small household appliances, boilers, water heaters, etc.
- Heating and air conditioning equipment and thermostats.
- Automotive: dimmers, climate controls, position sensors.
- Industrial electronic: multimeters, oscilloscopes, test equipment, time relay.

Models

All models shown here have the standard rotor for the 14mm series, the arrow (P). Models can be manufactured with any rotor listed on the rotor menu. The color of the housing or rotor can also be modified. SMD configuration can be available on request.

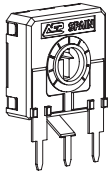

CA14 H0
CE14 H0

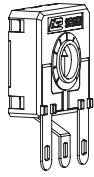

CA14 HC0
CE14 HC0

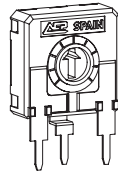

CA14 H2,5
CE14 H2,5

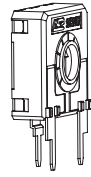

CA14 H4
CE14 H4

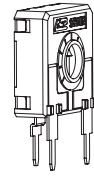

CA14 H5
CE14 H5

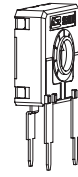

CA14 HA5
CE14 HA5

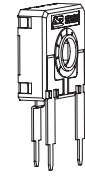

CA14 HL5
CE14 HL5

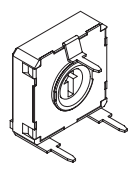

CA14 V12,5
CE14 V12,5

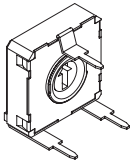

CA14 VA12,5
CE14 VA12,5

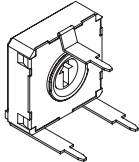

CA14 VL12,5
CE14 VL12,5

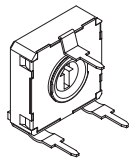

CA14 VR12,5
CE14 VR12,5

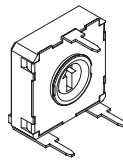

CA14 V15
CE14 V15

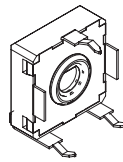

CA14 V15...CFF
CE14 V15...CFF

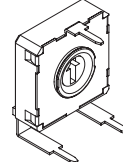

CA14 V17,5
CE14 V17,5

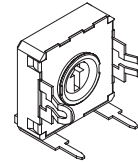

CA14 VD7,5
CE14 VD7,5

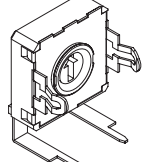

CA14 VD11
CE14 VD11

Rotors

The rotor by default is the arrow (P). Accessories are designed for the N, Z and T rotors, unless otherwise stated.

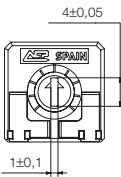

P

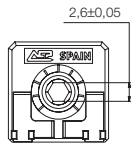

M

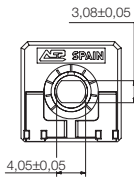

N

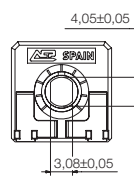

Z

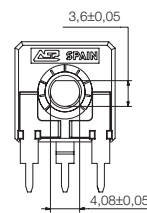

D

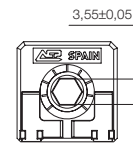

E

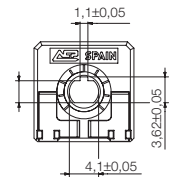

T

Shafts

• **CA14.** Shafts are available in different colors. They can also be provided in accordance with UL 94 V-0. Potentiometers can be supplied with shafts already inserted in. ACP can also study special shafts.

• **CE14.** Shafts provided in accordance with UL 94 V-0 are available in different colors. Potentiometers can be supplied with shafts already inserted in. ACP can also study special shafts.

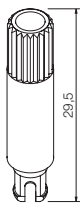

14008

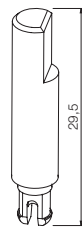

14015

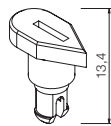

14042

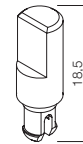

14056

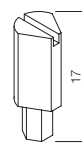

14065
For the M rotor



14066

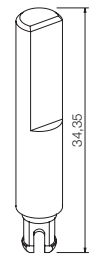

14067

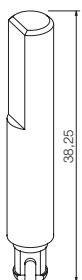

14072

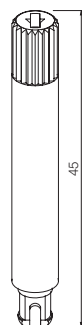

14073

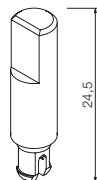

14081

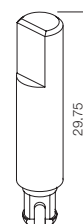

14084

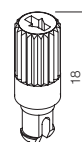

14117

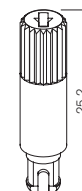

14187

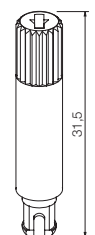

14250

Thumbwheels

• **CA14.** This thumbwheel is available in different colors. It can also be provided in accordance with UL 94 V-0. Potentiometers can be supplied with thumbwheels already inserted in. ACP can also study special requests for thumbwheels.

• **CE14.** This thumbwheel in accordance with UL 94 V-0 is available in different colors. Potentiometers can be supplied with thumbwheels already inserted in. ACP can also study special requests for thumbwheels.

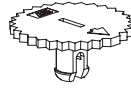

14003

Terminals

By default, terminals are always straight for the 14mm size, as shown on the “models” menu. ACP can provide crimped terminals (with “snap in”), to better hold the component to the board prior to soldering.

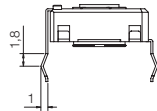

SNP

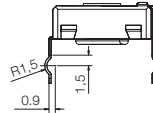

SNR

Adjustment possibilities

ACP's potentiometers can be adjusted through either the front side (WT) or the collector side (WTI):

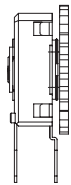

WTI
Collector side

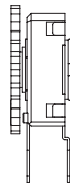

WT
Front side

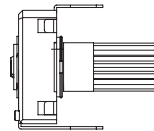

WTI
Collector side

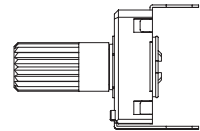

WT
Front side

Potentiometers with cut track

The resistive element in this potentiometer has an area with very high resistive values, resulting in an open circuit. Recommended for lighting regulation.

With cut at the beginning of the track CCW: Off-On.

With cut at the end of track- CW: On-Off. Others position available on request.

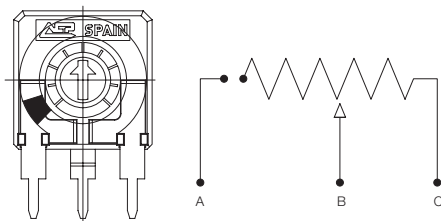

CCW: Off-On

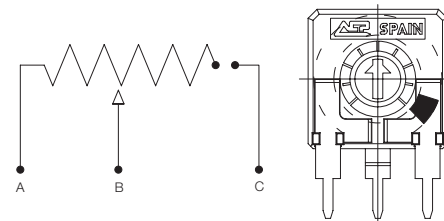

CW: On-Off

Packaging

Bulk packaging: Potentiometers are first bagged and then introduced in boxes:

Potentiometer model	+ Shaft or thumbwheel inserted	Pieces per box (130 x 60 x 90)
H2,5 - H4 - H5 - HA5 - HL5 - HC0 - H0	- (only potentiometers)	200 (models with * : 150)
V12,5 - VA12,5 - VL12,5 - V15 - V17,5* - VD11*	14003, 14117, 14042	100
VD7,5 - VR12,5	14008, 14015, 14250, 14187, 14056, 14065 14066, 14067, 14072, 14073, 14081, 14084	75

Tape and reel (T&R) packaging will be available for SMD configurations, on request.

Potentiometers with detents

ACP's "detent" (DT) feature is specially suitable for control applications. Our patented design has improved the performance of these potentiometers:

- Longer mechanical life: 10.000 cycles.
- More stable electrical parameters.
- Improved reliability and Contact Resistance Variation (CRV).
- Narrower tolerances for detent positioning.

Detents can be lighter or stronger, or even a combination of both feelings. They can also be evenly distributed along the angle (standard) or tailored to match customers' request. They can also be combined with special tapers: constant value areas, different slopes, etc.

Examples:

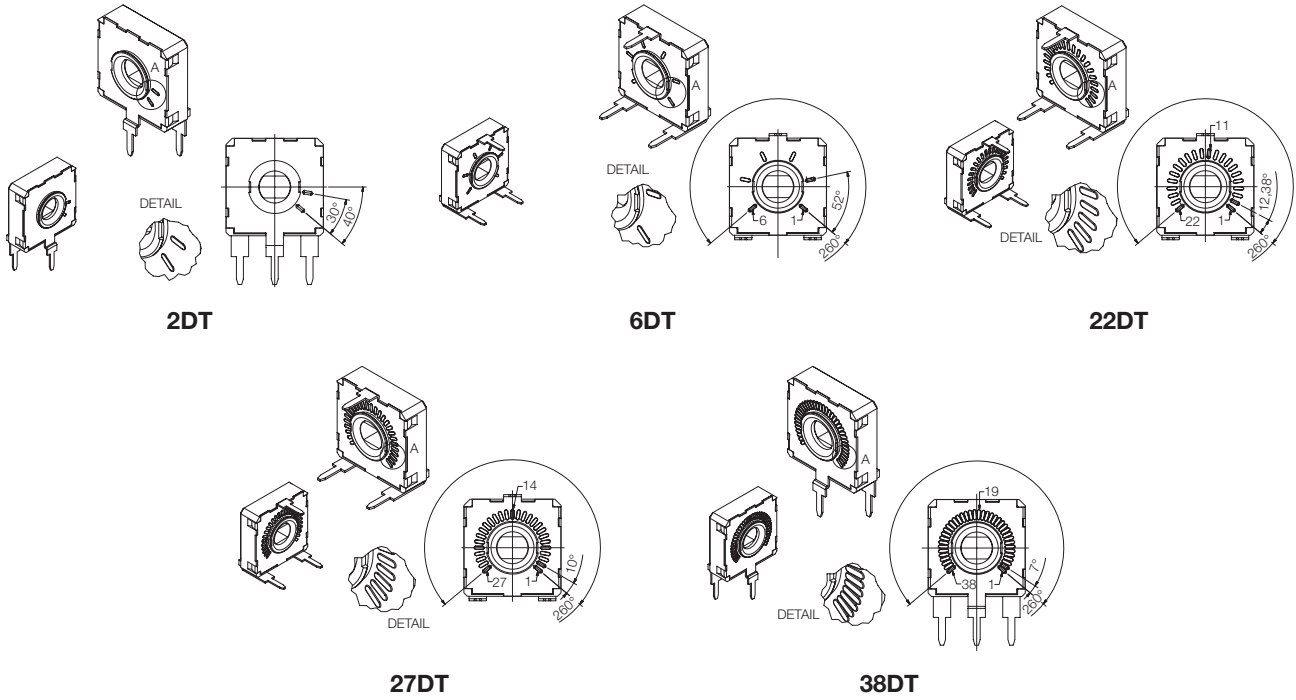



CA14. Electric Specifications

These are standard features; other specifications can be studied on request.

Range of resistance values Lin (A) Log (B) Antilog (C)	$100\Omega \leq R_n \leq 5M\Omega$ 1 K Ω ... 2,2 M Ω
Tolerance Special tolerances available on request	100 Ω ... 1M Ω $\pm 20\%$ >1M Ω ... 5M Ω $\pm 30\%$ Out of range: $R_n > 5M\Omega$: +50%, -30%
Variation laws	Lin (A), Log (B), Antilog (C) Other tapers available on request
Residual resistance	Lin (A), Log (B), Antilog (C) $\leq 5 \cdot 10^{-3} R_n$ Minimum value 2 Ω
CRV - Contact Resistance Variation (dynamic)	$\leq 3\% R_n$
CRV - Contact Resistance Variation (static)	$\leq 5\% R_n$
Maximum power dissipation at 40° C. Lin (A) No Lin (B, C)	0,25W 0,13W
Maximum voltage at 40°C Lin (A) No Lin (B, C)	250VDC 200VDC
Operating temperature	-25°C ... +70°C
Temperature coefficient	100 Ω - 10K Ω \rightarrow +200/ -300 ppm. >10K Ω - 5M Ω \rightarrow +200/ -500 ppm



CA14. Mechanical Specifications

Resistive element	Carbon technology
Angle of rotation (mechanical)	265° \pm 5°
Wiper position	Middle position: 50% \pm 15°
Angle of rotation (electrical)	245° \pm 20°
Max. stop torque	10 Ncm
Max. push/pull on rotor	50 N
Wiper torque	< 2,5 Ncm (0,5 ... 3,5Ncm for pots. with detents)
Mechanical life	1000 cycles (more available on request) (10.000 cycles for pots. with detents)



CA14. Test

Test // Conditions // Typical variation of Nominal Resistance

Damp heat // 500 h. at 40°C and 95% RH // +5%; -2%
Thermal cycles // 16h at 85°C, plus 2h at -25°C // $\pm 2,5\%$
Load life // 1.000 h. at 40°C // +0%; -5%
Mechanical life // 1000 cycles at 10 c.p.m. and at 23°C \pm 2°C // $\pm 3\%$
Soldering effect // 2 seconds at 350°C // $\pm 1\%$
Storage (3 years) // at 23°C \pm 2°C // $\pm 3\%$
For further information on tests, go to TESTS AND RELIABILITY on pages 10-11.

All specifications are given at 23°C \pm 2°C and 50% \pm 25% RH.



CE14. Electric Specifications

These are standard features; other specifications can always be studied on request.

Range of resistance values Lin (A) Log (B) and Antilog(C)	$100\Omega \leq R_n \leq 5M\Omega$ 1K Ω ... 2,2M Ω
Tolerance Special tolerances available on request	100 Ω ... 1M Ω $\pm 20\%$ >1M Ω ... 5M Ω $\pm 30\%$ Out of range: $R_n > 5M\Omega$: +50%, -30%
Variation laws	Lin (A) Log (B), Antilog (C) and other tapers available on request
Residual resistance	Lin (A) $\leq 2\Omega$
CRV - Contact Resistance Variation (dynamic)	$\leq 3\% R_n$
CRV - Contact Resistance Variation (static)	$\leq 5\% R_n$
Maximum power dissipation at 70° C. Lin (A) Non Lin (B, C)	0,7W See note 1
Maximum voltage at 40°C Lin (A) Non Lin (B, C)	250VDC See note 1
Operating temperature	-40°C ... +125°C
Temperature coefficient	± 100 ppm.

Note 1: Value depends on taper, please, inquire.



CE14. Mechanical Specifications

Resistive element	Cermet
Angle of rotation (mechanical)	265° \pm 5°
Wiper position	Middle position: 50% \pm 15°
Angle of rotation (electrical)	245° \pm 20°
Max. stop torque	10 Ncm
Max. push/pull on rotor	50 N
Wiper torque	< 2,5 Ncm (0,5 ... 3,5Ncm for pots. with detents)
Mechanical life	1000 cycles (more available on request) (10.000 cycles for pots. with detents)



CE14. Test

Test // Conditions // Typical variation of Nominal Resistance

Damp heat // 500 h. at 40°C and 95% RH // $\pm 2\%$
Thermal cycles // 16h at 90°C, plus 2h at -40°C // $\pm 2\%$
Load life // 1.000 h. at 70°C // $\pm 2\%$
Mechanical life // 1000 cycles at 10 c.p.m. and at 23°C \pm 2°C // $\pm 2\%$
Soldering effect // 2 seconds at 350°C // $\pm 1\%$
Storage (3 years) // at 23°C \pm 2°C // $\pm 1\%$
For further information on tests, go to TESTS AND RELIABILITY on pages 10-11.

CA14 CE14 HOW TO ORDER

- **EXAMPLE: CA14NH2,5-10KA2020 10DT SNP PI WT14117-BA**
- **EXAMPLE: CE14NH2,5-10KA2020 10DT SNP PI WT14117-BAV0**

Standard features								Extra features							Assembled accessory			
Series	Rotor	Model	Packg	Ohm value	Taper	Tol	Life	Track	Detents	Snap in	Housing	Rotor	Wiper	Lin	Assembly	Ref #	Color	Flam.
1	2	3	4	5	6	7	8	9	10	11	12	13	14	15		16		17
CA14/CE14	N	H2,5		-10K	A	2020		10DT	SNP				PI		WT	14117	-BA	-V0

Standard configuration		Customized products	
Dimensions:	14mm	A drawing is requested to order a customized product. The code assigned will include all special specifications.	
Protection:	<ul style="list-style-type: none"> • CA14: IP 5 (dust-proof) • CE14: IP 5 (dust-proof). Self-extinguishable, to meet UL 94 V-0 		
Substrate:	<ul style="list-style-type: none"> • CA14: Carbon technology • CE14: Cermet 	Series, rotor, model and total resistive value are given before the special code: CA14PH2,5 10K CODE C00111.	
Color:	<ul style="list-style-type: none"> • CA14: Blue housing with white rotor • CE14: Brown housing with white rotor 		
Packaging:	Bulk		
Wiper position:	at 50% ±15°		
Terminals:	Straight, without SNAP IN.		
Marking:	Resistive value marked on housing. Others on request		

1 - Series

- CA14
- CE14

3 - Model and pitch

H0	HC0	H2,5	H4	H5	HA5	HL5	V12,5
VA12,5	VL12,5	VR12,5	VD11	VD7,5	V15	V17,5	V15...OFF

HSMD and VSMD models can be available on request.

5 - Resistance value

Taper:	Lin (A)	Log (B), Antilog (C)
Value Rn	100 Ω / 100 ... / ... 5 MΩ / 5M	1KΩ / 1K ... / ... 2,2 MΩ / 2M2

Other resistive values available on request.

7 - Tolerance

100 Ω ≤ Rn ≤ 1MΩ: ±20%	2020
1 MΩ ≤ Rn ≤ 5MΩ: ±30%	3030
For out of range values: Rn > 5MΩ, tol : +50% - 30%	5030

Special tolerances available: <5% ... 10%, etc.

9 - Cut track

At beginning of track, CCW: Off - On	PCI
At end of track, CW: On - Off	PCF

11 - Crimped terminals (SNAP IN)

SNAP IN P	SNP
SNAP IN R	SNR

2 - Rotors

P (standard)	M	N	Z	D	E	T	F
--------------	---	---	---	---	---	---	---

4 - Packaging

	Through-hole	SMD models
Bulk	(blank)... ⁽¹⁾	On request
T&R (Tape and reel)	(N.A.) ⁽²⁾	On request

(1) If blank, bulk packaging is implied.

(2) N.A. - Not Available: Tape and Reel packaging is only available for SMD terminals.

6 - Resistance law / taper

Lin - Linear	A
Log - Logarithmic	B (on request for CE)
Antilog - Antilogarithmic	C (on request for CE)
- Special tapers have codes assigned:	CODE YXXXXX

Please, indicate terminal position when ordering a special taper.

8 - Operating life (cycles)

Standard (1000cycles)	-(leave blank)
Long life: LV + the number of cycles. ex: LV10 for 10000 cycles ⁽¹⁾	LVXX: ex: LV10

(1) Others on request.

10 - Detents (DT)

One detent at the beginning	DTI
One detent at the end	DTF
X number of detents	XDT: 10DT

Detents readily available: 1, 2, 3, 4, 5, 6, 8, 9, 17, 22, 27, up to 38 -evenly distributed along 260°±3°.

Others on request.

12 - Housing color

- **CA14:** standard is blue
- **CE14:** standard is brown

With other colors -See color chart below-, for example, red CJ-color, ex.: CJ-RO

13 - Rotor color

Standard: white. With other colors: see color chart below RT-color; ex., red: RT-RO

14 - Wiper

Wiper position (Standard: 50% ± 15°)	(leave blank)
Initial or CCW	PI
Final or CW	PF
Others: following clock positions; at 3hours: P3H	PXH, ex: P3H
Wiper torque (Standard: <2,5Ncm)	(leave blank)
Low torque (< 1.5Ncm)	PGB

15 - Linearity

Independent linearity controlled & below x%, for example, 3%: LN3% LNx%; ex: LN3%
Absolute linearity controlled & below x% LAx%

16 - Potentiometers with assembled accessories

Assembled from terminal side	WT
Assembled from collector side	WTI
Accessory Reference See list of shafts and thumbwheels available	XXXXX Example: 14117
Color of shaft or thumbwheel	-YY Example, white: BA

17 - Flammability (according to UL 94 V-0)

• CA14: Not self-extinguishable	(leave blank)
Self-extinguishable according to standard UL 94 (including all plastic parts of the potentiometer: rotor, housing and accessory. If only one part needs to be V0, please, inform)	-V0
• CE14: All accessories assembled with cermet potentiometers will have the self-extinguishable property according to standard UL 94	-V0

For ordering spare accessories

Accessory reference - color- flammability. Ex. 14117-AZ-V0 is a blue self-extinguishable 14117 thumbwheel

XXXX-YY-__

Color chart for rotor, housing and accessories

Black ⁽¹⁾	NE
White	BA
Neutral	IN
Transparent	TA
Red	RO
Green	VE
Yellow	AM
Blue	AZ
Grey	GS
Brown	MR

(1) Black is not an option for housings.

Specifications on this catalogue are for reference only; they are subject to change without notice.



MCA9

Control
Carbon
Potentiometers
CA



MCE9

Control
Cermet
Potentiometers
CE

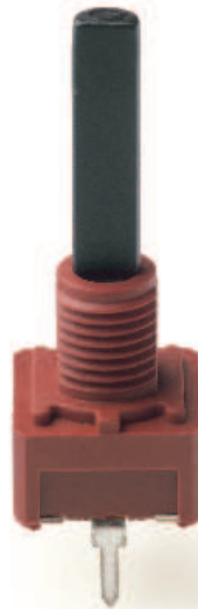



MCA9

9mm carbon control potentiometers with low cost plastic enclosure and shaft and protection type IP 5 (dust-proof).

Standard tapers available include linear, log and antilog. ACP can also study special requests.

Terminals are manufactured in tinned brass to guarantee better soldering and higher resistance to corrosion. They can be provided straight or crimped (with “snap in”), recommended to hold the potentiometer to the board prior to the soldering operation. SMD configuration can be available on request.

Our potentiometers can be manufactured in a wide range of possibilities regarding:

- Resistance value.
- Tolerance.
- Tapers / variation laws.
- Pitch.
- Positioning of the wiper (the standard is at 50%).
- Housing and rotor color.
- Mechanical life.
- Pause effect (up to 20 detents available).
- Self-extinguishable plastic parts according to UL 94 V-0.

Applications

- Electronic appliances: white and brown goods, small household appliances.
- Measurement and test equipment. Timers and relays.
- Lighting regulation.



MCE9

9mm cermet control potentiometers with low cost plastic enclosure and shaft and protection type IP 5 (dust-proof). Self-extinguishable plastic parts according to UL 94 V-0.

Standard taper is linear. Log, Antilog and other tapers are available on request. Laser trimming equipment in-house, allowing for very low tolerances.

Terminals are manufactured in tinned brass to guarantee better soldering and higher resistance to corrosion. They can be provided straight or crimped (with “snap in”), recommended to hold the potentiometer to the board prior to the soldering operation. SMD configuration can be available on request.

Our potentiometers can be manufactured in a wide range of possibilities regarding:

- Resistance value.
- Tolerance.
- Tapers / variation laws.
- Pitch.
- Positioning of the wiper (the standard is at 50%).
- Housing and rotor color.
- Mechanical life.
- Pause effect (up to 20 detents available).

Applications

- Electronic appliances: white and brown goods, small household appliances.
- Measurement and test equipment. Timers and relays.

Models

The color of the housing or rotor can be modified. SMD configuration can be available on request.

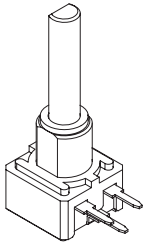

MCA9 H2,5
MCE9 H2,5

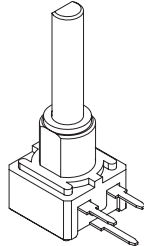

MCA9 H3,8
MCE9 H3,8

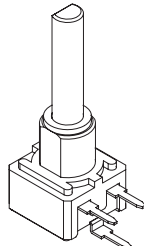

MCA9 H5
MCE9 H5

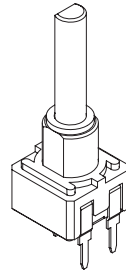

MCA9 V7,5
MCE9 V7,5

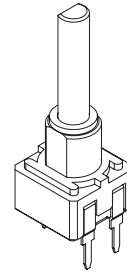

MCA9 V10
MCE9 V10

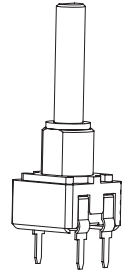

MCA9 VR10
MCE9 VR10

Shafts

Shafts are black by default. Other colors are available. ACP can also study special shafts. D dimension specified on drawings (end of catalogue).

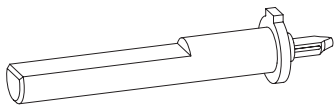

9006



9019

Shafts	D (±0,5 mm)
9006	23,3
9019	17,2

Terminals

By default, terminals are always straight for the 9mm size, as shown on the “models” menu.

ACP can provide crimped terminals (with “snap in”), to better hold the component to the board prior to soldering.

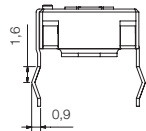

SNP

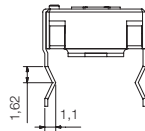

SNJ

Potentiometers with detents

ACP’s “detent” feature (DT) is specially suitable for control applications. Our patented design has improved the features of these potentiometers:

- Longer mechanical life: >10.000cycles.
- More stable electrical parameters.
- Improved reliability and Contact Resistance Variation (CRV).
- Narrower tolerances for detent positioning.

Detents can be lighter or stronger, or even a combination of both feelings. Detents can be evenly distributed along the angle (standard), or tailored to match customers’ request. They can also be combined with special tapers: constant value areas, different slopes, etc.

Examples: 4, 6 and 20 detents –evenly distributed–.

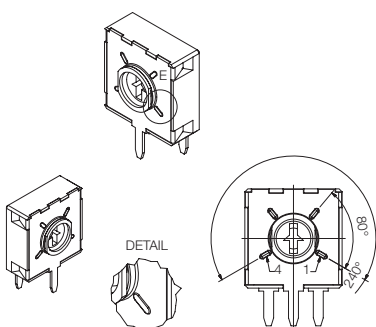

4DT

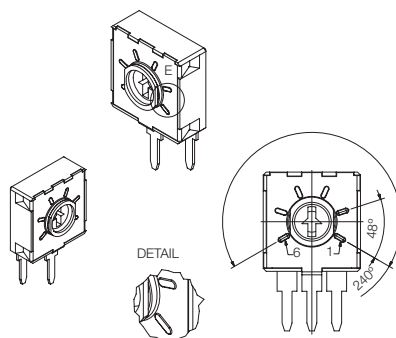

6DT

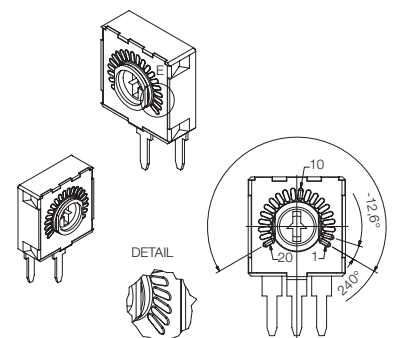

20DT

Adjustment possibilities

Should the shaft need to be positioned differently than shown on the “models” section, please, enclose a drawing.

Potentiometers with cut track

The resistive element in this potentiometer has an area with very high resistive values, resulting in an open circuit. Recommended for lighting regulation.

With cut at the beginning of the track CCW: Off-On.

With cut at the end of track- CW: On-Off. Others position available on request.

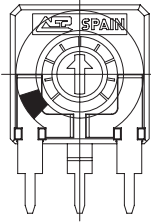

CCW: Off-On

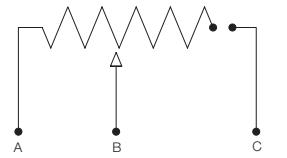
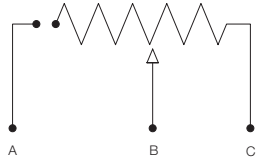

CW: On-Off

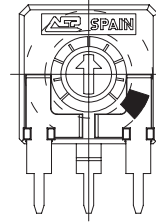



MCA9. Electric Specifications

These are standard features; other specifications can always be studied on request.

Range of resistance values Lin (A) Log (B) Antilog (C)	$100\Omega \leq R_n \leq 5M\Omega$ $1\text{ K}\Omega \dots 2,2\text{ M}\Omega$
Tolerance Special tolerances available on request	$100\Omega \dots 1M\Omega \pm 20\%$ $>1M\Omega \dots 5M\Omega \pm 30\%$ Out of range: $R_n > 5M\Omega$: +50%, -30%
Variation laws	Lin (A), Log (B), Antilog (C) Other tapers available on request
Residual resistance	Lin (A), Log (B), Antilog (C) $\leq 5 \cdot 10^{-3} R_n$ Minimum value 2Ω
CRV - Contact Resistance Variation (dynamic)	$\leq 3\% R_n$
CRV - Contact Resistance Variation (static)	$\leq 5\% R_n$
Maximum power dissipation at 40° C. Lin (A) Non Lin (B, C)	$0,15W$ $0,10W$
Maximum voltage at 40° C Lin (A) Non Lin (B, C)	$200VDC$ $150VDC$
Operating temperature	$-25^\circ C \dots +70^\circ C$
Temperature coefficient	$100\Omega - 10K\Omega \rightarrow +200/ -300\text{ ppm.}$ $>10K\Omega - 5M\Omega \rightarrow +200/ -500\text{ ppm}$



MCA9. Mechanical Specifications

Resistive element	Carbon technology
Angle of rotation (mechanical)	$240^\circ \pm 5^\circ$
Wiper position	Middle position: $50\% \pm 15^\circ$
Angle of rotation (electrical)	$220^\circ \pm 20^\circ$
Wiper torque	$< 2\text{ Ncm}$ ($0,4 \dots 3,5\text{Ncm}$ for pots. with detents)
Mechanical life	10.000 cycles (more available on request)
Max. stop torque	25Ncm
Max. push/pull on shaft	40N / 50N
Max. torque on the nut	50Ncm



MCA9. Test

Test // Conditions // Typical variation of Nominal Resistance

Damp heat // 500 h. at 40°C and 95% RH // +5%; -2%
Thermal cycles // 16h at 85°C, plus 2h at -25°C // $\pm 2,5\%$
Load life // 1.000 h. at 40°C // +0%; -5%
Mechanical life // 1000 cycles at 10 c.p.m. and at 23°C $\pm 2^\circ C$ // $\pm 3\%$
Soldering effect // 2 seconds at 350°C // $\pm 1\%$
Storage (3 years) // at 23°C $\pm 2^\circ C$ // $\pm 3\%$
For further information on tests, go to TESTS AND RELIABILITY on pages 10-11.



MCE9. Electric Specifications

These are standard features; other specifications can always be studied on request.

Range of resistance values Lin (A) Log (B) Antilog (C)	$100\Omega \leq R_n \leq 5M\Omega$ $1\text{ K}\Omega \dots 2,2\text{ M}\Omega$
Tolerance Special tolerances available on request	$100\Omega \dots 1M\Omega \pm 20\%$ $>1M\Omega \dots 5M\Omega \pm 30\%$ Out of range: $R_n > 5M\Omega$: +50%, -30%
Variation laws	Lin (A) Log (B), Antilog (C) and other tapers available on request
Residual resistance	Lin (A), Log (B), Antilog (C) $\leq 5 \cdot 10^{-3} R_n$ Minimum value 2Ω
CRV - Contact Resistance Variation (dynamic)	$\leq 3\% R_n$
CRV - Contact Resistance Variation (static)	$\leq 5\% R_n$
Maximum power dissipation at 40° C. Lin (A) Non Lin (B, C)	$0,5W$ <i>See note 1</i>
Maximum voltage at 40° C Lin (A) Non Lin (B, C)	$200VDC$ <i>See note 1</i>
Operating temperature	$-40^\circ C \dots +125^\circ C$
Temperature coefficient	$\pm 100\text{ppm.}$

Note 1: Value depends on taper, please, inquire.



MCE9. Mechanical Specifications

Resistive element	Cermet
Angle of rotation (mechanical)	$240^\circ \pm 5^\circ$
Wiper position	Middle position: $50\% \pm 15^\circ$
Angle of rotation (electrical)	$220^\circ \pm 20^\circ$
Wiper torque	$< 2\text{ Ncm}$ ($0,4 \dots 3,5\text{Ncm}$ for pots. with detents)
Mechanical life	10.000 cycles (more available on request)
Max. stop torque	25Ncm
Max. push/pull on shaft	40N / 50N
Max. torque on the nut	50Ncm



MCE9. Test

Test // Conditions // Typical variation of Nominal Resistance

Damp heat // 500 h. at 40°C and 95% RH // $\pm 2\%$
Thermal cycles // 16h at 85°C, plus 2h at -25°C // $\pm 2\%$
Load life // 1.000 h. at 40°C // $\pm 2\%$
Mechanical life // 1000 cycles at 10 c.p.m. and at 23°C $\pm 2^\circ C$ // $\pm 2\%$
Soldering effect // 2 seconds at 350°C // $\pm 1\%$
Storage (3 years) // at 23°C $\pm 2^\circ C$ // $\pm 3\%$
For further information on tests, go to TESTS AND RELIABILITY on pages 10-11.

MCA9 MCE9 HOW TO ORDER

- EXAMPLE: MCA9DH5-10KA2020 SNP PI WT9006-BA
- EXAMPLE: MCE9DH5-10KA2020 SNP PI WT9006-V0BA

Standard features								Extra features							Assembled accessory			
Series	Rotor	Model	Packg	Ohm value	Taper	Tol	Life	Track	Detents	Snip in	Housing	Rotor	Wiper	Lin	Assembly	Ref #	Color	Flam.
1	2	3	4	5	6	7	8	9	10	11	12	13	14	15		16		17
MCA9/MCE9	D	H5		-10K	A	2020				SNP			PI		WT	9006	-BA	

Standard configuration		Customized products	
Dimensions:	9mm	A drawing is requested to order a customized product. The code assigned will include all special specifications.	
Protection:	<ul style="list-style-type: none"> • MCA9: IP 5 (dust-proof) • MCE9: IP 5 (dust-proof) Self-extinguishable, to meet UL 94 V-0 	Series, rotor, model and total resistive value are given before the special code: MCA9DH2,5 10K CODE C00111.	
Substrate:	<ul style="list-style-type: none"> • MCA9: Carbon technology • MCE9: Cermet 		
Color:	<ul style="list-style-type: none"> • MCA9: Blue housing with white rotor • MCE9: Brown housing with white rotor 		
Packaging:	Blister		
Wiper position:	at 50% ±15°		
Terminals:	Straight, without SNAP IN.		
Marking:	Resistive value marked on housing. Others on request.		

1 - Series

- MCA9
- MCE9

3 - Model and pitch

H2,5	H3,8	H5	V7,5	V10	VR10
------	------	----	------	-----	------

5 - Resistance value

Taper:	Lin (A)	Log (B), Antilog (C)
Value Rn	100 Ω / 100 ... / ... 5 MΩ / 5M	1KΩ / 1K ... / ... 2,2 MΩ / 2M2

Other resistive values available on request.

7 - Tolerance

100 Ω ≤ Rn ≤ 1MΩ: ±20%	2020
1 MΩ ≤ Rn ≤ 5MΩ: ±30%	3030
For out of range values: Rn > 5MΩ, tol : +50% - 30%	5030
Special tolerances available: <5% ... 10%, etc.	

9 - Cut track

At beginning of track, CCW: Off - On	PCI
At end of track, CW: On - Off	PCF

11 - Crimped terminals (SNAP IN)

SNAP IN P	SNP
SNAP IN J	SNJ

2 - Rotors

D

4 - Packaging

Blister	84 units per blister
	420 units per box of 430 x 270 x 120

6 - Resistance law / taper

Lin - Linear	A
Log - Logarithmic	B (on request for CE)
Antilog - Antilogarithmic	C (on request for CE)
- Special tapers have codes assigned:	CODE YXXXXX

Please, indicate terminal position when ordering a special taper.

8 - Operating life (cycles)

Standard (10.000cycles)	(leave blank)
Long life: LV + the number of cycles. ex: LV45 for 45000 cycles ⁽¹⁾	LVXX: ex: LV45

(1) Others on request.

10 - Detents (DT)

One detent at the beginning CCW	DTI
One detent at the end CW	DTF
X number of detents. Ex., 10	XDT: 10DT

Detents readily available: 3, 4, 6, 7, 9, 10, up to 20 -evenly distributed along 240°±5°. Others on request.

12 - Housing color

- **MCA9:** standard is blue
 - **MCE9:** standard is brown
- With other colors -see color chart below-, for example, red CJ-color, ex: CJ-R0

13 - Rotor color

Standard is white	
With other colors -see color chart below-, for example, red	RT-color; ex: RT-RO

15 - Linearity

Independent linearity controlled & below x%, for example, 3%: LN3%	LNx%; ex: LN3%
Absolute linearity controlled & below x%	LAx%

17 - Flammability (according to UL 94 V-0)

• MCA9: Not self-extinguishable	(leave blank)
Self-extinguishable according to standard UL 94 (including all plastic parts of the potentiometer: rotor, housing and accessory. If only one part needs to be V0, please, inform)	-V0
• MCE9: All accessories assembled with cermet potentiometers will have the self-extinguishable property according to standard UL 94	-V0

14 - Wiper position

Standard is at 50% ± 15°	(leave blank)
Initial or CCW	PI
Final or CW	PF
Others: following clock positions; at 3hours: P3H	PXH, ex: P3H

16 - Assembled accessories

Assembled	WT
Reference (9006 or 9019)	9XXX Example: 9006
Color of shaft (standard is black)	-YY Example, white: BA

Color chart for rotor, housing and accessories

Black ⁽¹⁾	NE
White	BA
Neutral	IN
Transparent	TA
Red	RO
Green	VE
Yellow	AM
Blue	AZ
Grey	GS
Brown	MR

(1) Black is not an option for housings.

Specifications on this catalogue are for reference only; they are subject to change without notice.



MCA14

Control
Carbon
Potentiometers
CA



MCE14

Control
Cermet
Potentiometers
CE

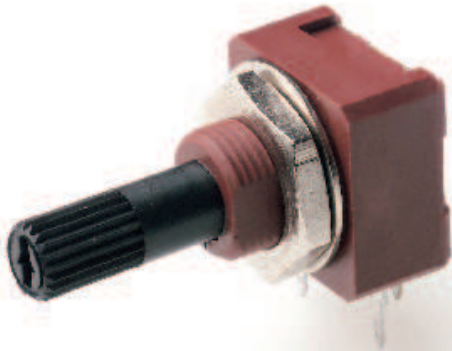



MCA14

14mm control carbon potentiometers with low cost plastic enclosure and shaft and protection type IP 5 (dust-proof).

Standard tapers available include linear, log and antilog. ACP can also study special requests.

Terminals are manufactured in tinned brass to guarantee better soldering and higher resistance to corrosion. They can be provided straight or crimped (with “snap in”), recommended to hold the potentiometer to the board prior to the soldering operation. SMD configuration can be available on request.

Our potentiometers can be manufactured in a wide range of possibilities regarding:

- Resistance value.
- Tolerance.
- Tapers / variation laws.
- Pitch.
- Positioning of the wiper (the standard is at 50%).
- Housing, rotor or accessory color.
- Mechanical life.
- Pause effect (up to 38 detents available).
- Self-extinguishable plastic parts according to UL 94 V-0.

Applications

- Electronic appliances: white and brown goods, small household appliances.
- Measurement and test equipment.
- Lighting regulation.



MCE14

14mm control cermet potentiometers with low cost plastic enclosure and shaft and protection type IP 5 (dust-proof). Self-extinguishable plastic parts according to UL 94 V-0.

Standard taper is linear. Log, Antilog and other tapers are available on request. Laser trimming equipment in-house, allowing for very low tolerances.

Terminals are manufactured in tinned brass to guarantee better soldering and higher resistance to corrosion. They can be provided straight or crimped (with “snap in”), recommended to hold the potentiometer to the board prior to the soldering operation. SMD configuration can be available on request.

Our potentiometers can be manufactured in a wide range of possibilities regarding:

- Resistance value.
- Tolerance.
- Tapers / variation laws.
- Pitch.
- Positioning of the wiper (the standard is at 50%).
- Housing, rotor or accessory color.
- Mechanical life.
- Pause effect (up to 38 detents available).

Applications

- Electronic appliances: white and brown goods, small household appliances.
- Measurement and test equipment.
- Lighting regulation.

MCA14 MCE14

Models

The color of the housing or rotor can be modified. SMD configuration can be available on request.

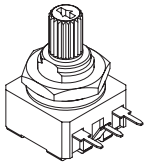

MCA14 H0
MCE14 H0

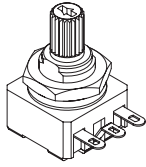

MCA14 HC0
MCE14 HC0

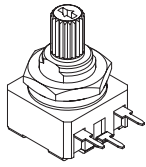

MCA14 H2,5
MCE14 H2,5

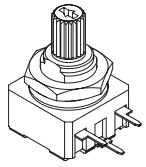

MCA14 H4
MCE14 H4

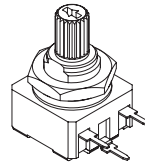

MCA14 H5
MCE14 H5

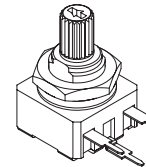

MCA14 HA5
MCE14 HA5

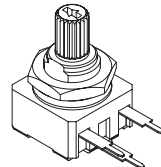

MCA14 HL5
MCE14 HL5

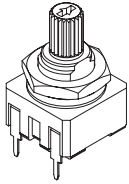

MCA14 V12,5
MCE14 V12,5

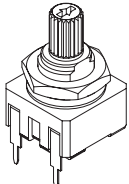

MCA14 VA12,5
MCE14 VA12,5

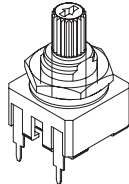

MCA14 VL12,5
MCE14 VL12,5

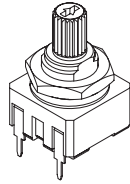

MCA14 V15
MCE14 V15

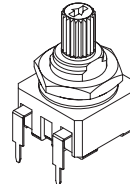

MCA14 V17,5
MCE14 V17,5

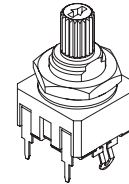

MCA14 VD7,5
MCE14 VD7,5

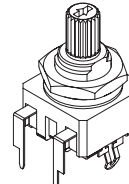

MCA14 VD11
MCE14 VD11

Shafts

Shafts are black by default. Other colors are available. ACP can also study special shafts. D dimension specified on drawings (end of catalogue).

Shafts	D (±0,5mm)
14008	20,6
14015	20
14066	20,6
14067	24,8
14072	28,8

Shafts	D (±0,5mm)
14073	35,5
14081	15,2
14084	20,2
14187	15,6
14250	22



14008



14015



14066



14067

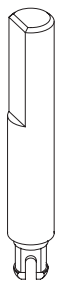

14072



14073

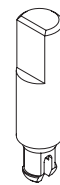

14081



14084

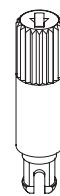

14187



14250

Terminals

By default, terminals are always straight for the 14mm size, as shown on the “models” menu.

ACP can provide crimped terminals (with “snap in”), to better hold the component to the board prior to soldering.

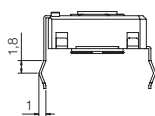

SNP

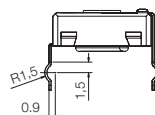

SNR

Adjustment and orientation

Should the shaft need to be positioned differently than shown on this catalogue, please, enclose a drawing.

Potentiometers with detents

ACP's "detent" feature (DT) is specially suitable for control applications. Our patented design has improved the features of these potentiometers:

- Longer mechanical life: >10.000cycles.
- More stable electrical parameters.
- Improved reliability and Contact Resistance Variation (CRV).
- Narrower tolerances for detent positioning.

Detents can be lighter or stronger, or even a combination of both feelings. Detents can be evenly distributed along the angle (standard), or tailored to match customers' request. They can also be combined with special tapers: constant value areas, different slopes, etc.
Examples:

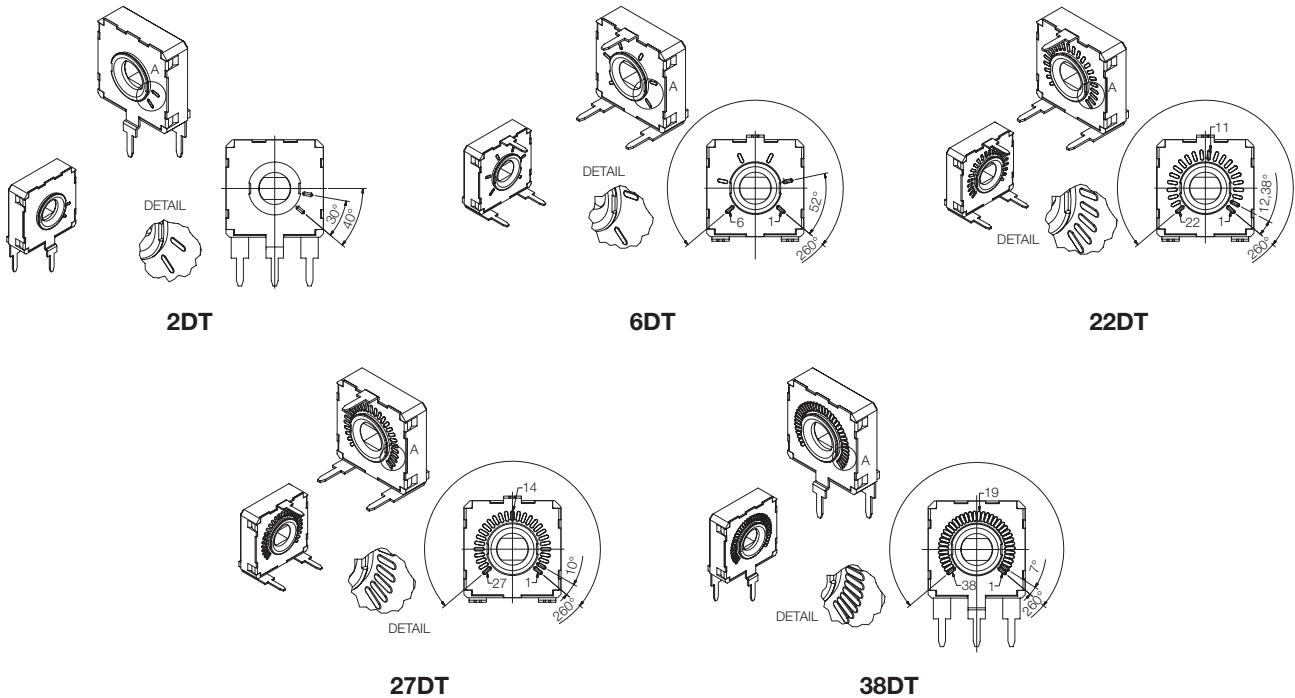

Potentiometers with cut track

The resistive element in this potentiometer has an area with very high resistive values, resulting in an open circuit. Recommended for lighting regulation.

With cut at the beginning of the track CCW: Off-On.

With cut at the end of track- CW: On-Off. Other positions available on request.

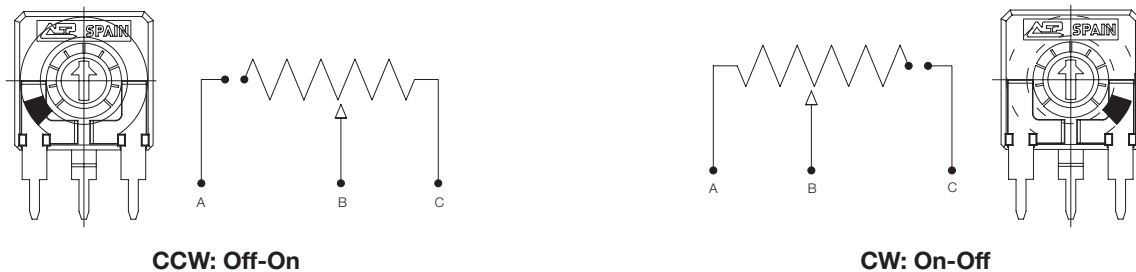



MCA14. Electric Specifications

These are standard features; other specifications can always be studied on request.

Range of resistance values Lin (A) Log (B) Antilog (C)	$100\Omega \leq R_n \leq 5M\Omega$ 1 K Ω ... 2,2 M Ω
Tolerance Special tolerances available on request	100 Ω ... 1M Ω $\pm 20\%$ >1M Ω ... 5M Ω $\pm 30\%$ Out of range: R _n > 5M Ω : +50%, -30%
Variation laws	Lin (A) Log (B), Antilog (C) and other tapers available on request
Residual resistance	Lin (A), Log (B), Antilog (C) $\leq 5 \cdot 10^{-3} R_n$ Minimum value 2 Ω
CRV - Contact Resistance Variation (dynamic)	$\leq 3\% R_n$
CRV - Contact Resistance Variation (static)	$\leq 5\% R_n$
Maximum power dissipation at 40° C. Lin (A) Non Lin (B, C)	0,25W 0,13W
Maximum voltage at 40° C Lin (A) Non Lin (B, C)	250VDC 200VDC
Operating temperature	-25°C ... +70°C
Temperature coefficient	100 Ω - 10K Ω \rightarrow +200/ -300 ppm. >10K Ω - 5M Ω \rightarrow +200/ -500 ppm



MCA14. Mechanical Specifications

Resistive element	Carbon technology
Angle of rotation (mechanical)	265° \pm 5°
Wiper position	Middle position: 50% \pm 15°
Angle of rotation (electrical)	245° \pm 20°
Wiper torque	< 2 Ncm (0,4 ... 3,5Ncm for pots. with detents)
Mechanical life	10.000 cycles (more available on request)
Max. stop torque	15Ncm
Max. push/pull on shaft	50 N / 25 N
Max. torque on the nut	80 Ncm



MCA14. Test

Test // Conditions // Typical variation of Nominal Resistance

Damp heat // 500 h. at 40°C and 95% RH // +5%; -2%
Thermal cycles // 16h at 85°C, plus 2h at -25°C // $\pm 2,5\%$
Load life // 1.000 h. at 40°C // +0%; -5%
Mechanical life // 1000 cycles at 10 c.p.m. and at 23°C \pm 2°C // $\pm 3\%$
Soldering effect // 2 seconds at 350°C // $\pm 1\%$
Storage (3 years) // at 23°C \pm 2°C // $\pm 3\%$
For further information on tests, go to TESTS AND RELIABILITY on pages 10-11.



MCE14. Electric Specifications

These are standard features; other specifications can always be studied on request.

Range of resistance values Lin (A) Log (B) Antilog (C)	$100\Omega \leq R_n \leq 5M\Omega$ 1 K Ω ... 2,2 M Ω
Tolerance Special tolerances available on request	100 Ω ... 1M Ω $\pm 20\%$ >1M Ω ... 5M Ω $\pm 30\%$ Out of range: R _n > 5M Ω : +50%, -30%
Variation laws	Lin (A) Log (B), Antilog (C) and other tapers available on request
Residual resistance	Lin (A), Log (B), Antilog (C) $\leq 5 \cdot 10^{-3} R_n$ Minimum value 2 Ω
CRV - Contact Resistance Variation (dynamic)	$\leq 3\% R_n$
CRV - Contact Resistance Variation (static)	$\leq 5\% R_n$
Maximum power dissipation at 70° C. Lin (A) Non Lin (B, C)	0,7W <i>See note 1</i>
Maximum voltage at 40° C Lin (A) Non Lin (B, C)	250VDC <i>See note 1</i>
Operating temperature	-40°C ... +125°C
Temperature coefficient	± 100 ppm.

Note 1: Value depends on taper, please, inquire.



MCE14. Mechanical Specifications

Resistive element	Cermet
Angle of rotation (mechanical)	265° \pm 5°
Wiper position	Middle position: 50% \pm 15°
Angle of rotation (electrical)	245° \pm 20°
Wiper torque	< 2 Ncm (0,4 ... 3,5Ncm for pots. with detents)
Mechanical life	10.000 cycles (more available on request)
Max. stop torque	15Ncm
Max. push/pull on shaft	50 N / 25 N
Max. torque on the nut	80 Ncm



MCE14. Test

Test // Conditions // Typical variation of Nominal Resistance

Damp heat // 500 h. at 40°C and 95% RH // +5%; -2%
Thermal cycles // 16h at 90°C, plus 2h at -40°C // $\pm 2\%$
Load life // 1.000 h. at 70°C // $\pm 2\%$
Mechanical life // 1000 cycles at 10 c.p.m. and at 23°C \pm 2°C // $\pm 2\%$
Soldering effect // 2 seconds at 350°C // $\pm 1\%$
Storage (3 years) // at 23°C \pm 2°C // $\pm 1\%$
For further information on tests, go to TESTS AND RELIABILITY on pages 10-11.

MCA14 MCE14 HOW TO ORDER

- EXAMPLE: MCA14NH2,5-10K2020 SNP PI WT14187-BA
- EXAMPLE: MCE14NH2,5-10K2020 SNP PI WT14187-BA-V0

Standard features								Extra features							Assembled accessory			
Series	Rotor	Model	Packg	Ohm value	Taper	Tol	Life	Track	Detents	Snap in	Housing	Rotor	Wiper	Lin	Assembly	Ref #	Color	Flam.
1	2	3	4	5	6	7	8	9	10	11	12	13	14	15	16	17		
MCA14/MCE14	N	H2,5		10K	A	2020				SNP			PI		WT	14187	-BA	

Standard configuration		Customized products	
Dimensions:	14mm	A drawing is requested to order a customized product. The code assigned will include all special specifications.	
Protection:	<ul style="list-style-type: none"> • MCA14: IP 5 (dust-proof) • MCE14: IP 5 (dust-proof) Self-extinguishable, to meet UL 94 V-0 	Series, rotor, model and total resistive value are given before the special code: MCA14PH2,5 10K CODE C00111.	
Substrate:	<ul style="list-style-type: none"> • MCA14: Carbon technology • MCE14: Cermet 		
Color:	<ul style="list-style-type: none"> • MCA14: Blue housing with white rotor, black shaft • MCE14: Brown housing with white rotor, black shaft 		
Packaging:	Blister		
Wiper position:	at 50% ±15°		
Mech. life:	10.000cycles		
Terminals:	Straight, without SNAP IN.		
Marking:	Resistive value marked on housing. Others on request.		

1 - Series

- MCA14
- MCE14

3 - Model and pitch

H0	HC0	H2,5	H4	H5	HA5	HL5
V12,5	VA12,5	VL12,5	V15	V17,5	VD7,5	VD11

5 - Resistance value

Taper:	Lin (A)	Log (B), Antilog (C)
Value Rn	100 Ω / 100 ... / ... 5 MΩ / 5M	1KΩ / 1K ... / ... 2,2 MΩ / 2M2

Other resistive values available on request.

7 - Tolerance

100 Ω ≤ Rn ≤ 1MΩ: ±20%	2020
1 MΩ ≤ Rn ≤ 5MΩ: ±30%	3030
For out of range values: Rn > 5MΩ, tol : +50% - 30%	5030

Special tolerances available: <5% ... 10%, etc.

9 - Cut track

At beginning of track, CCW: Off - On	PCI
At end of track, CW: On - Off	PCF

11 - Crimped terminals (SNAP IN)

SNAP IN P	SNP
SNAP IN R	SNR

2 - Rotors

N

4 - Packaging

Blister	84 units per blister
	420 units per box of 430 x 270 x 120

6 - Resistance law / taper

Lin - Linear	A
Log - Logarithmic	B (on request for CE)
Antilog - Antilogarithmic	C (on request for CE)
- Special tapers have codes assigned:	CODE YXXXXX

Please, indicate terminal position when ordering a special taper.

8 - Operating life (cycles)

Standard (10.000cycles)	(leave blank)
Long life: LV + the number of cycles. ex: LV45 for 45000 cycles ⁽¹⁾	LVXX: ex: LV45

(1) Others on request.

10 - Detents (DT)

One detent at the beginning	DTI
One detent at the end	DTF
X number of detents	XDT: 10DT

Detents readily available: 1, 2, 3, 4, 5, 6, 8, 9, 17, 22, 27, up to 38 -evenly distributed along 260°±3°-. Others on request.

12 - Housing color

- MCA14: standard is blue
- MCE14: standard is brown

With other colors -see color chart below-, for example, red CJ-color, ex: CJ-R0

13 - Rotor color

Standard is white	
With other colors -see color chart below-, for example, red	RT-color; ex: RT-RO

15 - Linearity

Independent linearity controlled & below x%, for example, 3%: LN3%	LNx%; ex: LN3%
Absolute linearity controlled & below x%	LAx%

17 - Flammability (according to UL 94 V-0)

• MCA14: Not self-extinguishable	(leave blank)
Self-extinguishable according to standard UL 94 (including all plastic parts of the potentiometer: rotor, housing and accessory. If only one part needs to be V0, please, inform)	-V0
• MCE14: All accessories assembled with cermet potentiometers will have the self-extinguishable property according to standard UL 94	-V0

14 - Wiper position

Standard is at 50% ± 15°	(leave blank)
Initial or CCW	PI
Final or CW	PF
Others: following clock positions; at 3hours: P3H	PXH, ex: P3H

16 - Assembled accessories

Assembled	WT
Shaft reference	14XXX Example: 14187
Color of shaft (standard is black)	-YY Example, white: BA

Color chart for rotor, housing and accessories

Black ⁽¹⁾	NE
White	BA
Neutral	IN
Transparent	TA
Red	RO
Green	VE
Yellow	AM
Blue	AZ
Grey	GS
Brown	MR

(1) Black is not an option for housings.

DRAWINGS CA6

Tolerances 6 mm (in mm.):

<1	±0,1
1...<5	±0,3
5...	±0,5

Model types. CA6

CA6 H2,5

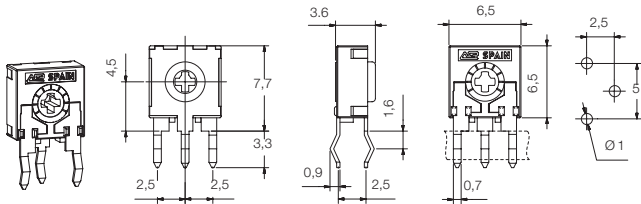

CA6 V2,5

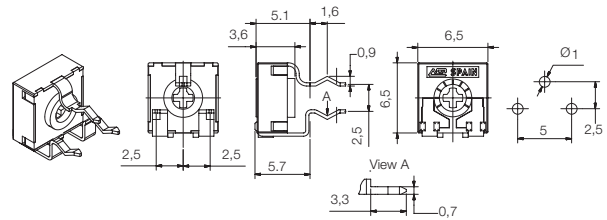

CA6 V5

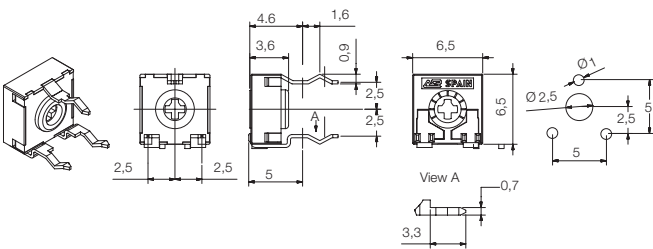

CA6 VS5

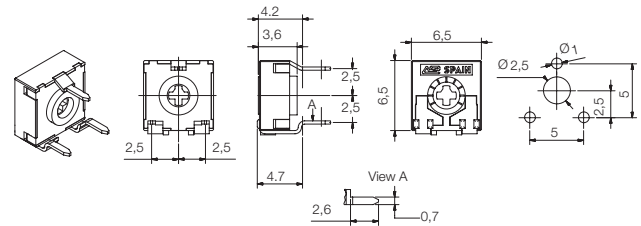

CA6 HSMD

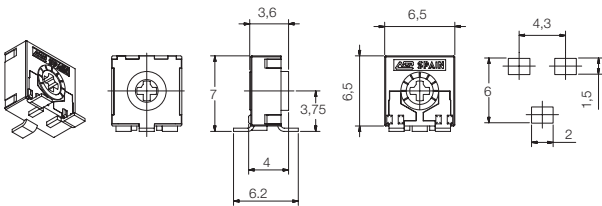

CA6 VSMD

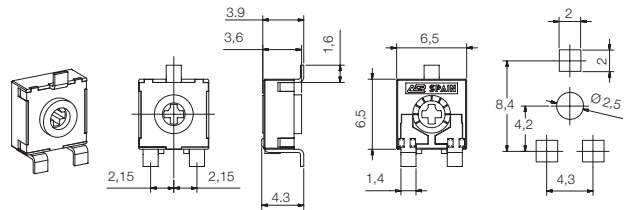

Thumbwheels CA6

6001

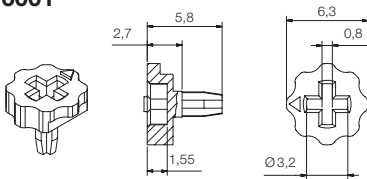

6030

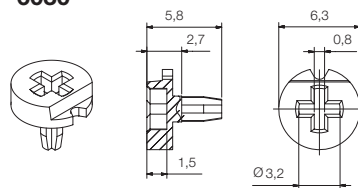

6032

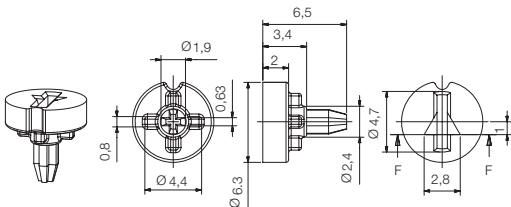

Specifications on this catalogue are for reference only; they are subject to change without notice.

DRAWINGS CA6

Tolerances 6 mm (in mm.):

<1	±0,1
1...<5	±0,3
5...	±0,5

Shafts. CA6

6022

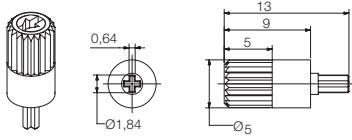

6023

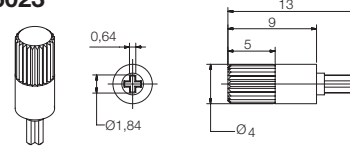

6024

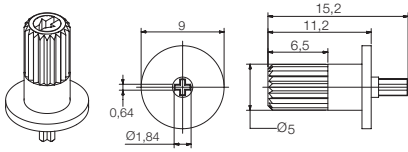

6025

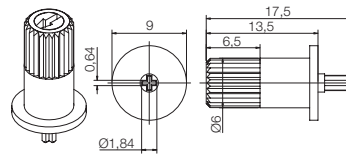

6028

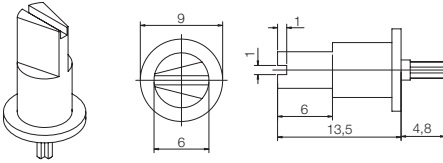

6031

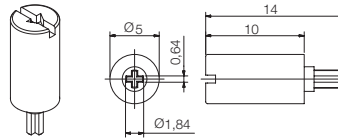

Specifications on this catalogue are for reference only; they are subject to change without notice.

DRAWINGS CA9 // CE9

Tolerances 9 mm (in mm.):

<1	±0,1
1...<5	±0,3
5...	±0,5

Model types. CA9 // CE9

CA9 H2,5 // CE9 H2,5

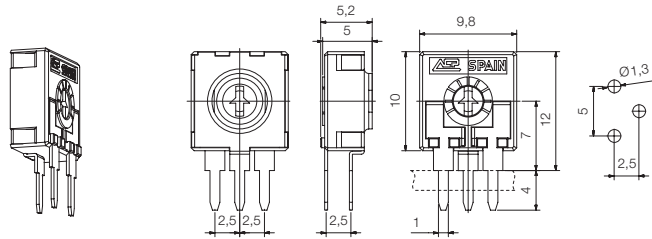

CA9 H3,8 // CE9 H3,8

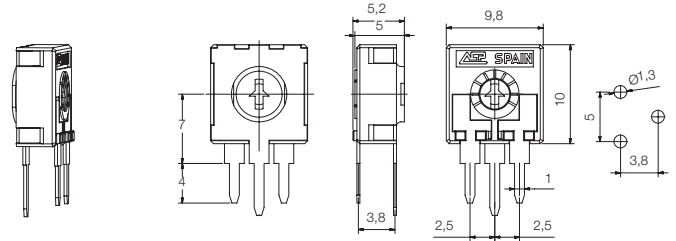

CA9 HS3,8 // CE9 HS3,8

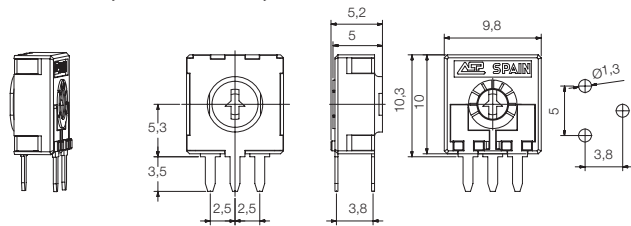

CA9 H5 // CE9 H5

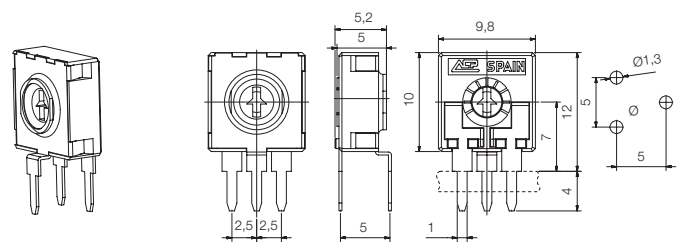

CA9 V7,5 // CE9 V7,5

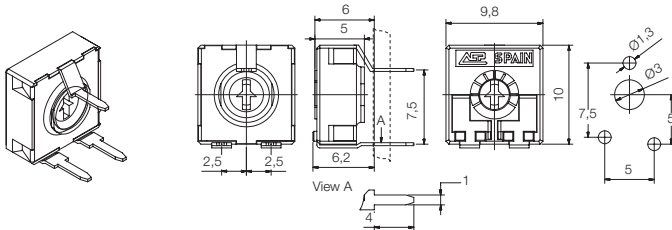

CA9 V10 // CE9 V10

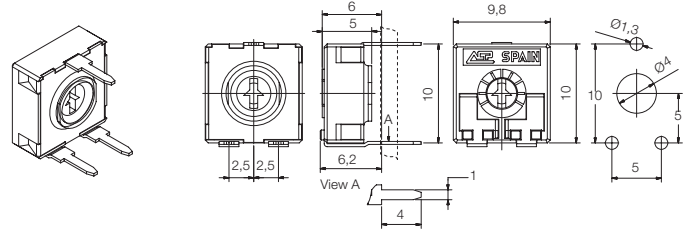

CA9 VR10 // CE9 VR10

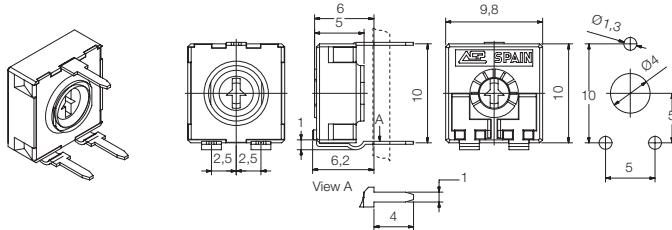

CA9 MAV10 // CE9 MAV10

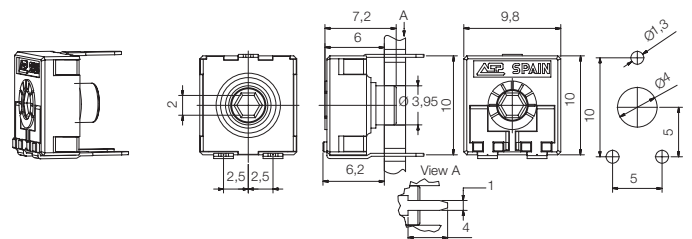

CA9 MTV10 // CE9 MTV10

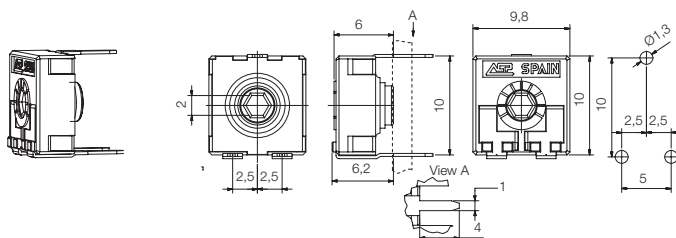

Specifications on this catalogue are for reference only; they are subject to change without notice.

DRAWINGS CA9 // CE9

Tolerances 9 mm (in mm.):

<1	±0,1
1...<5	±0,3
5...	±0,5

Thumbwheels. CA9 // CE9

9002

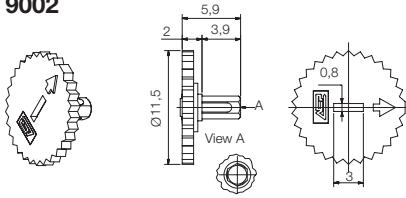

9041

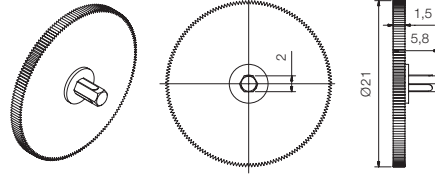

9060 For Rrotor

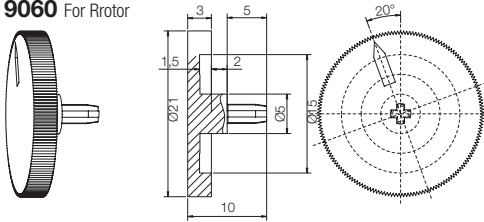

9061

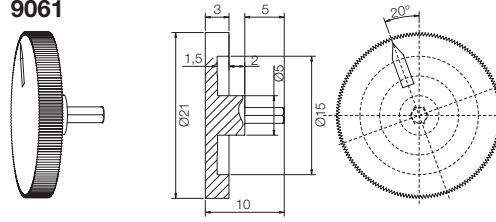

Shafts. CA9 // CE9

9004

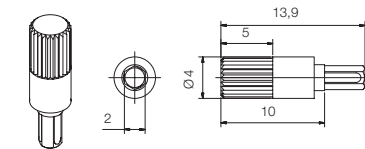

9005

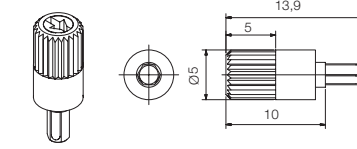

9006

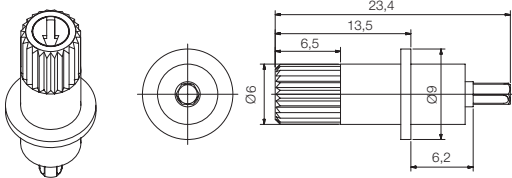

9009

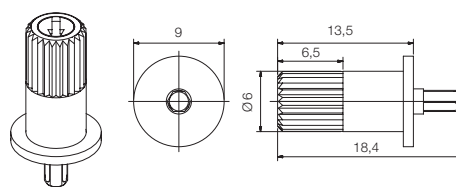

9010

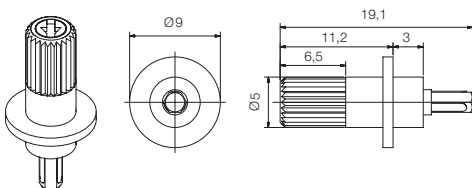

9018 For 6 potentiometers

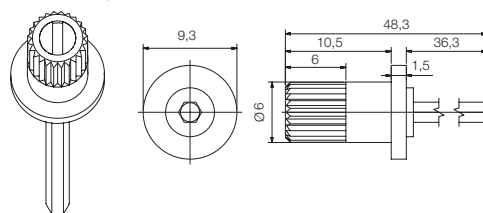

9039 For 4 potentiometers

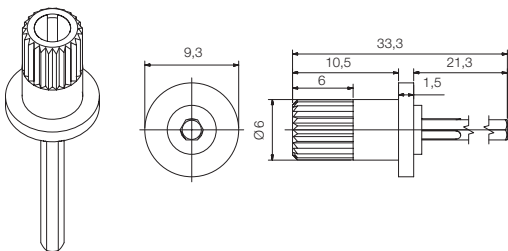

9047

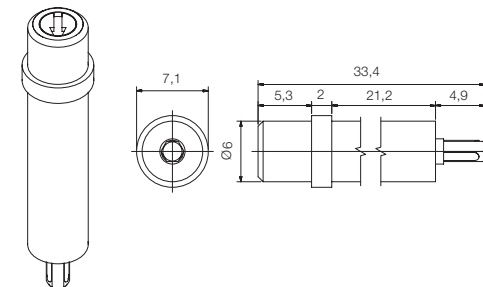

Specifications on this catalogue are for reference only; they are subject to change without notice.

DRAWINGS CA9 // CE9

Tolerances 9 mm (in mm.):

<1	±0,1
1...<5	±0,3
5...	±0,5

Shafts. CA9 // CE9

9048 For 2 potentiometers

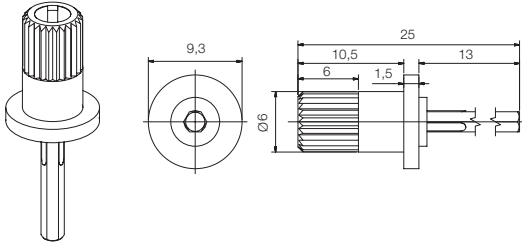

9051 For 4 potentiometers

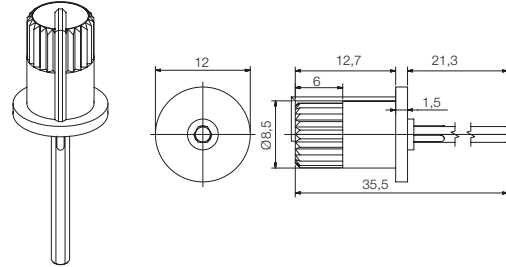

9053

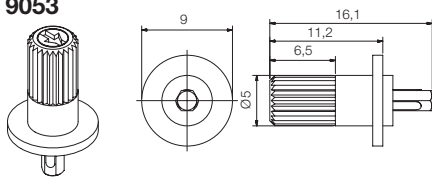

9054

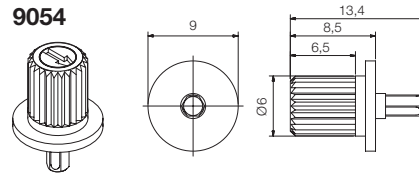

9055

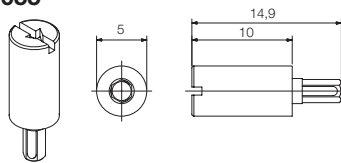

9056 For 8 potentiometers

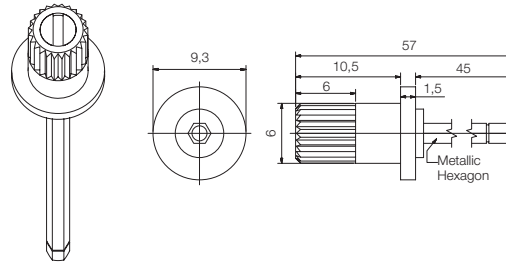

9059

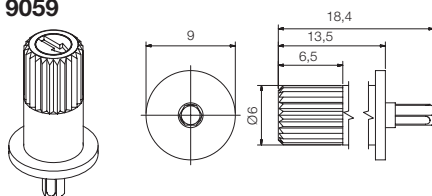

9063

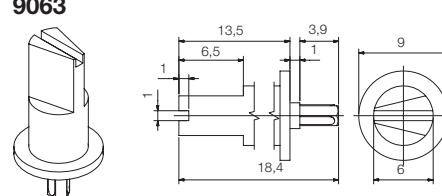

9064

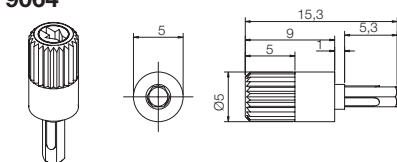

9067

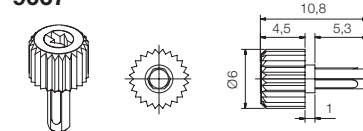

Specifications on this catalogue are for reference only; they are subject to change without notice.

DRAWINGS CA14 // CE14

Tolerances 14 mm (in mm.):

<1	±0,1
1...<10	±0,3
10...	±0,5

Model types. CA14 // CE14

CA14 H0 // CE14 H0

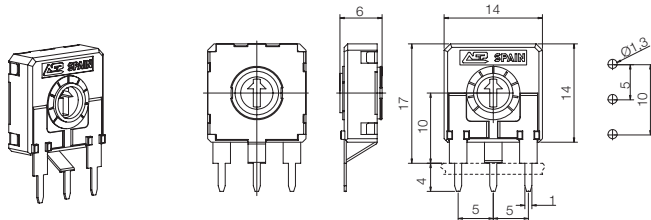

CA14 HC0 // CE14 HC0

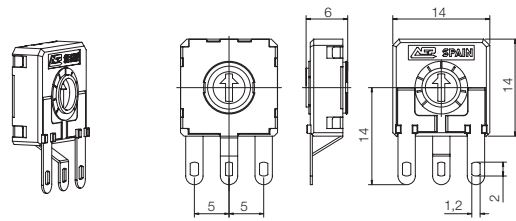

CA14 H2,5 // CE14 H2,5

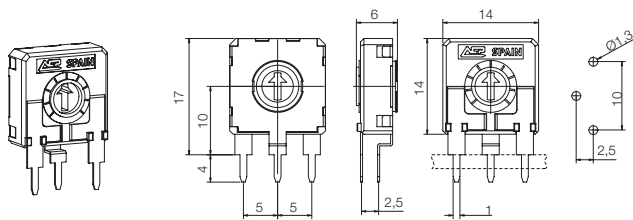

CA14 H4 // CE14 H4

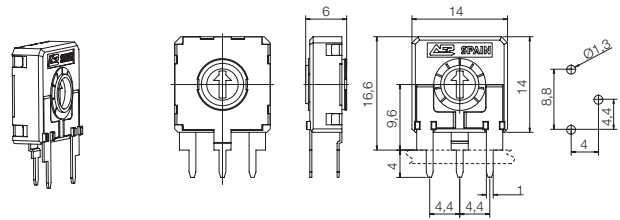

CA14 H5 // CE14 H5

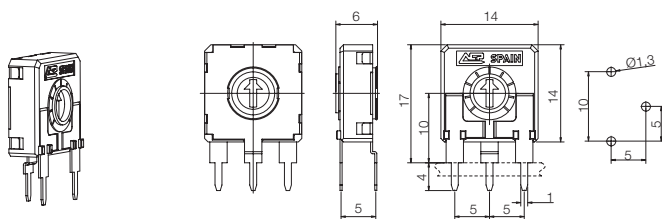

CA14 HA5 // CE14 HA5

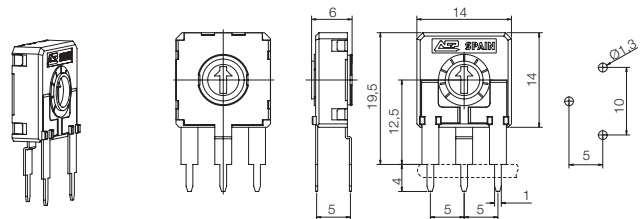

CA14 HL5 // CE14 HL5

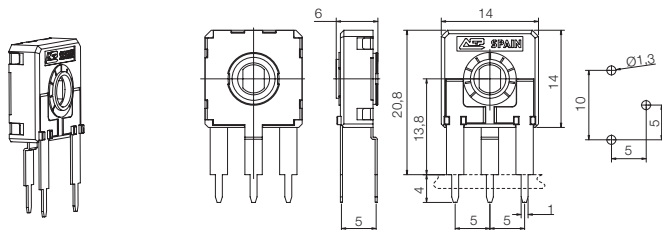

CA14 V12,5 // CE14 V12,5

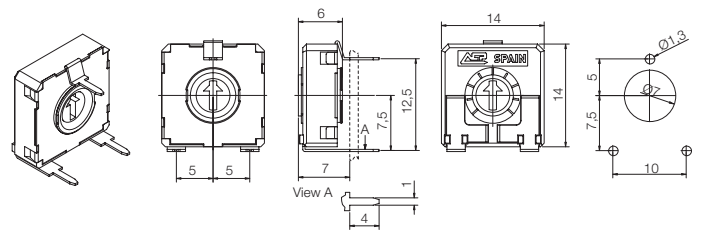

CA14 VA12,5 // CE14 VA12,5

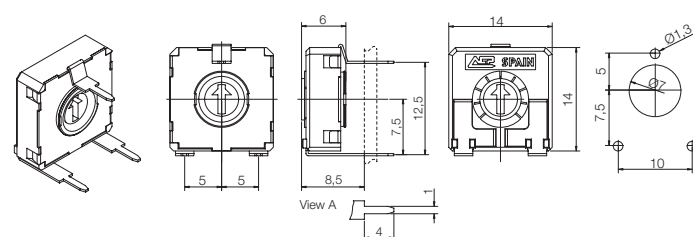

CA14 VL12,5 // CE14 VL12,5

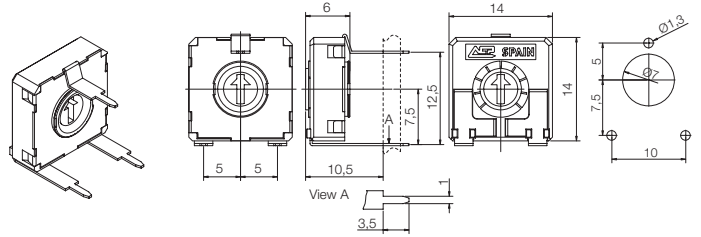

Specifications on this catalogue are for reference only; they are subject to change without notice.

DRAWINGS CA14 // CE14

Tolerances 14 mm (in mm.):

<1	±0,1
1...<10	±0,3
10...	±0,5

Model types. CA14 // CE14

CA14 VR12,5 // CE14 VR12,5

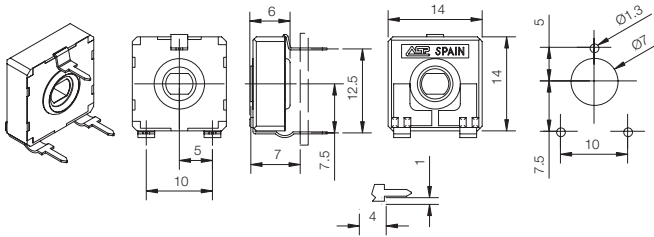

CA14 V15 // CE14 V15

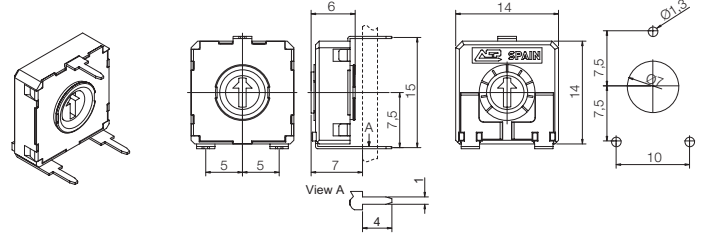

CA14 V15...CFF // CE14 V15...CFF

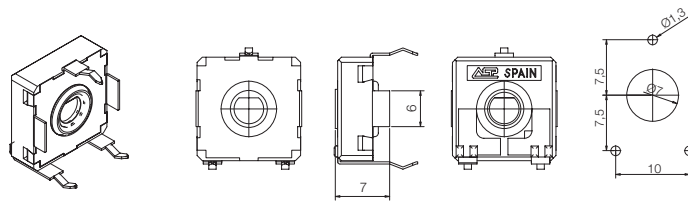

CA14 V17,5 // CE14 V17,5

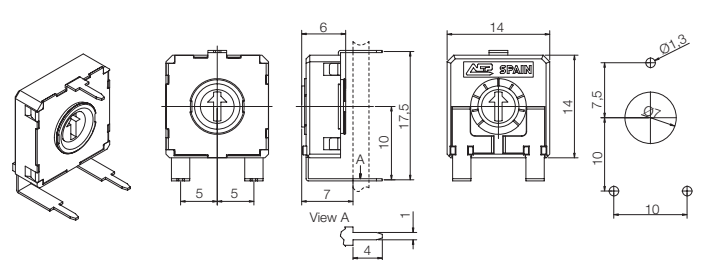

CA14 VD7,5 // CE14 VD7,5

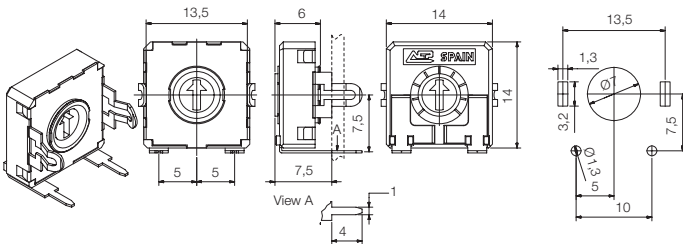

CA14 VD11 // CE14 VD11

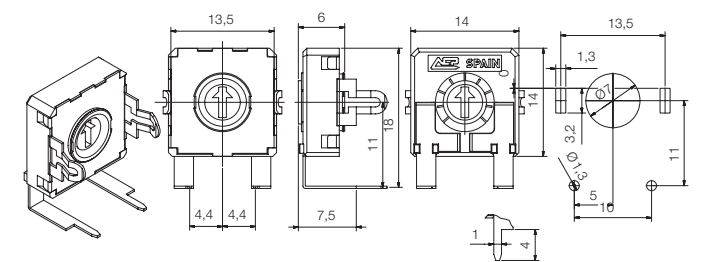

Thumbwheels. CA14 // CE14

14003

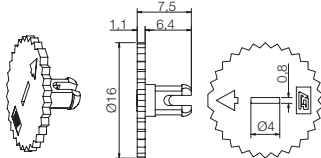

Shafts. CA14 // CE14

14008

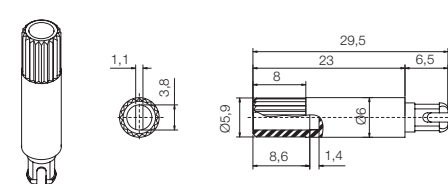

14015

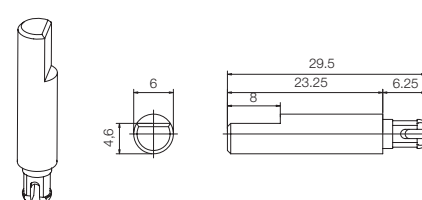

14042

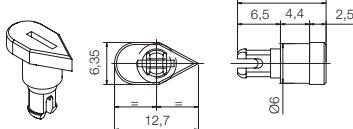

14056

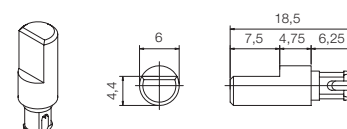

Specifications on this catalogue are for reference only; they are subject to change without notice.

DRAWINGS CA14 // CE14

Tolerances 14 mm (in mm.):

<1	±0,1
1...<10	±0,3
10...	±0,5

Shafts. CA14 // CE14

14065

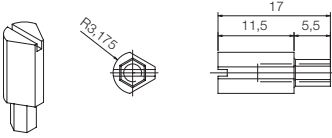

14066

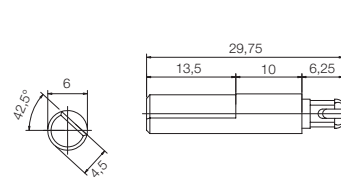

14067

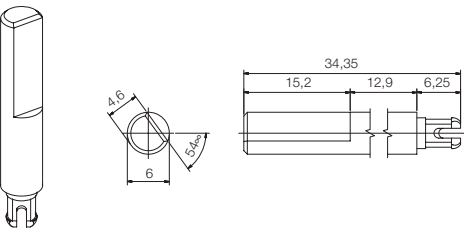

14072

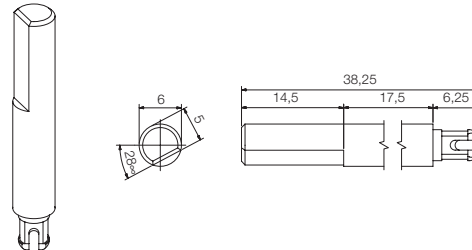

14073

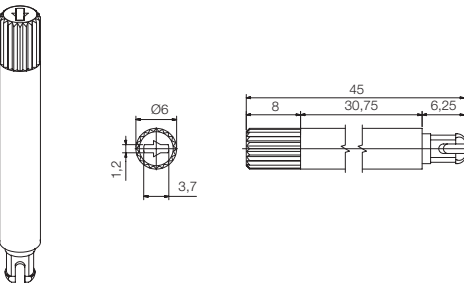

14081

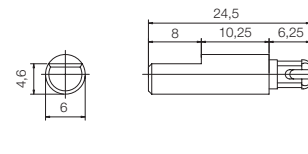

14084

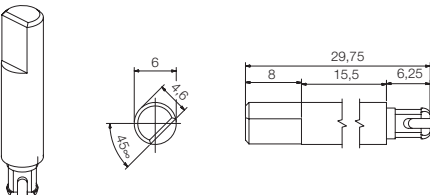

14117

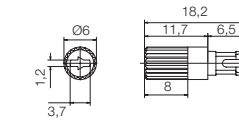

14187

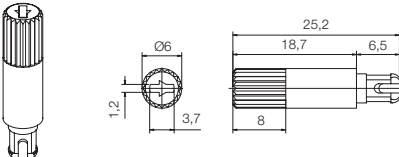

14250

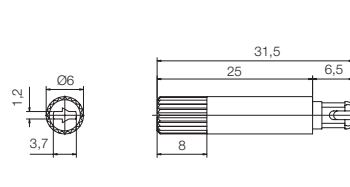

Specifications on this catalogue are for reference only; they are subject to change without notice.

DRAWINGS MCA9 // MCE9

Tolerances 9 mm (in mm.):

<1	±0,1
1...<5	±0,3
5...	±0,5

Model types. MCA9 // MCE9

MCA9 H2,5 // MCE9 H2,5

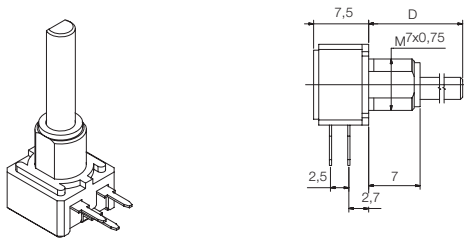

MC9 H3,8 // MCE9 H3,8

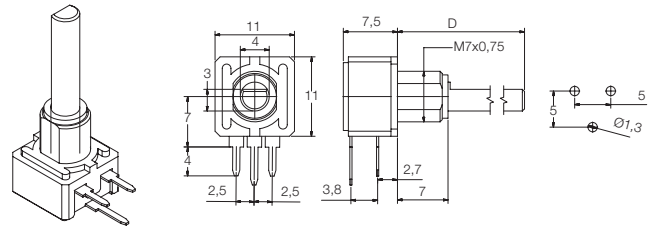

MCA9 H5 // MCE9 H5

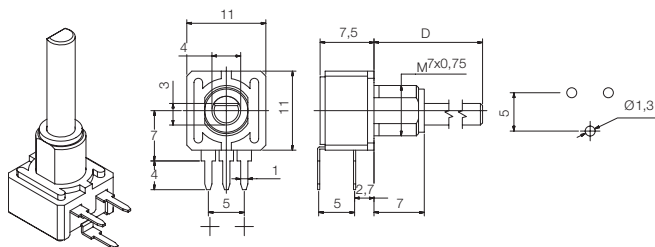

MCA9 V7,5 // MCE9 V7,5

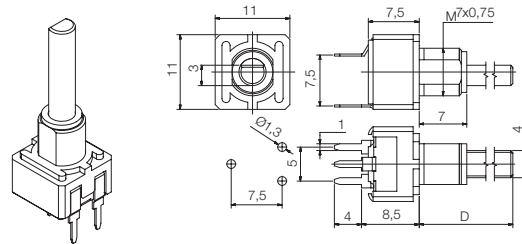

MCA9 V10 // MCE9 V10

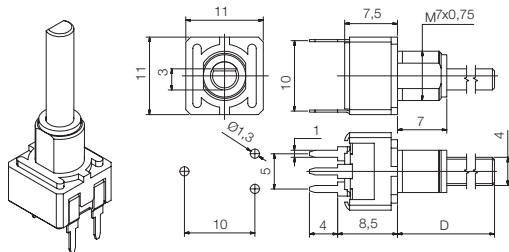

MCA9 VR10 // MCE9 VR10

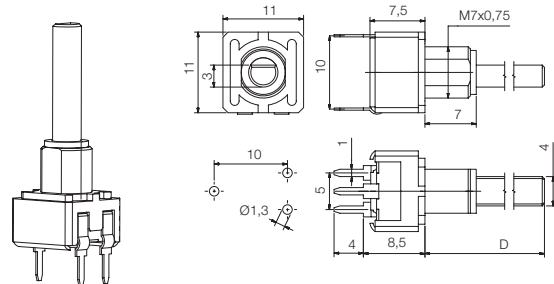

Shafts. MCA9 // MCE9

9006

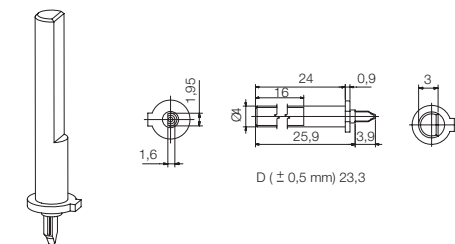

9019

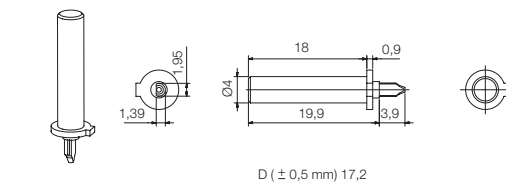

Washer and nut. MCA9 // MCE9

WASHER

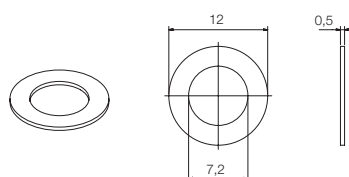

NUT

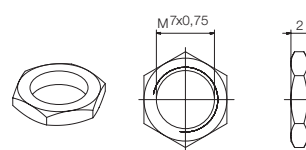

Specifications on this catalogue are for reference only; they are subject to change without notice.

DRAWINGS MCA14 // MCE14

Tolerances 14 mm (in mm.):

<1	±0,1
1...<10	±0,3
10...	±0,5

Model types. MCA14 // MCE14

MCA14 H0 // MCE14 H0

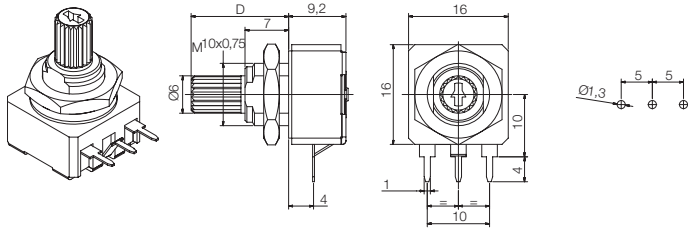

MCA14 HC0 // MCE14 HC0

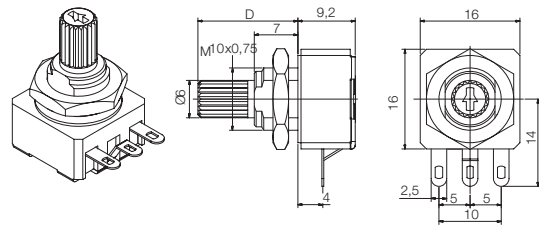

MCA14 H2,5 // MCE14 H2,5

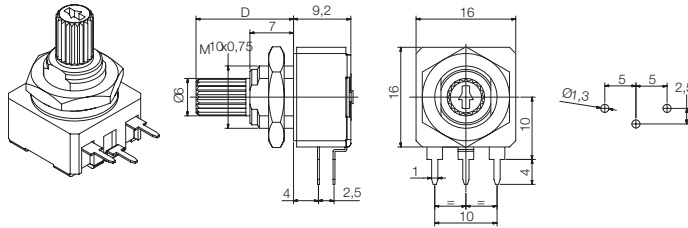

MCA14 H4 // MCE14 H4

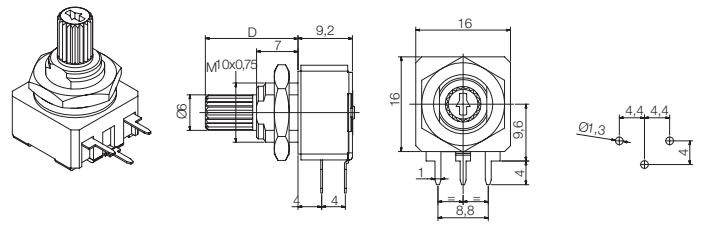

MCA14 H5 // MCE14 H5

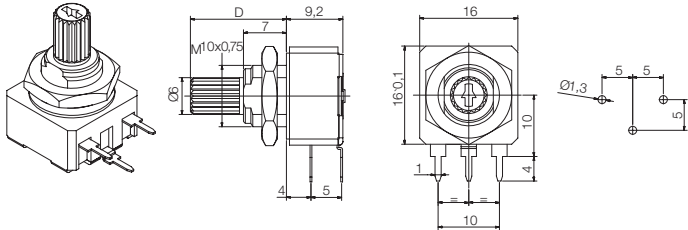

MCA14 HA5 // MCE14 HA5

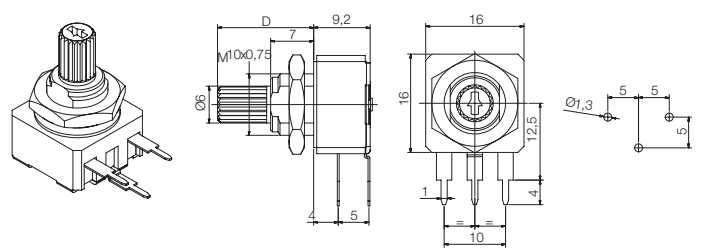

MCA14 HL5 // MCE14 HL5

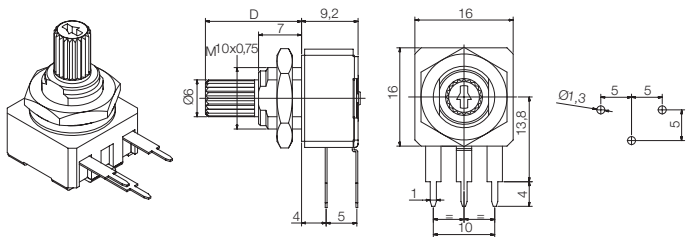

MCA14 V12,5 // MCE14 V12,5

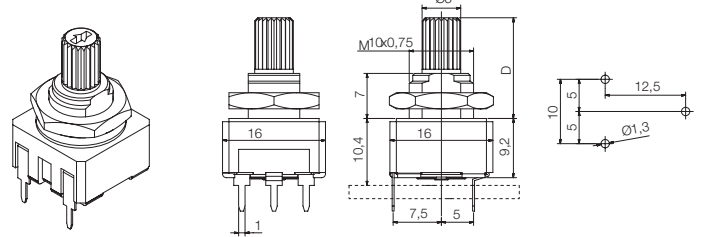

MCA14 VA12,5 // MCE14 VA12,5

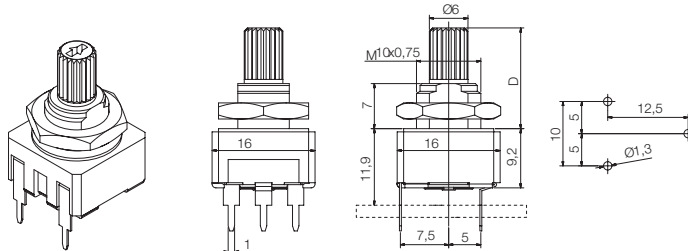

MCA14 VL12,5 // MCE14 VL12,5

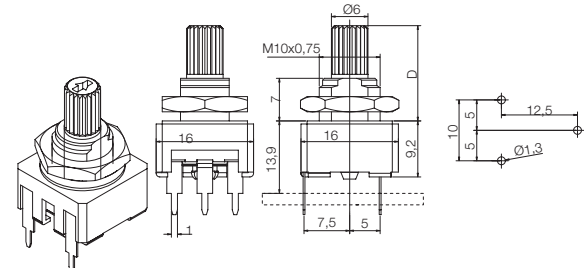

Specifications on this catalogue are for reference only; they are subject to change without notice.

DRAWINGS MCA14 // MCE14

Tolerances 14 mm (in mm.):

<1	±0,1
1...<10	±0,3
10...	±0,5

Model types. MCA14 // MCE14

MCA14 V15 // MCE14 V15

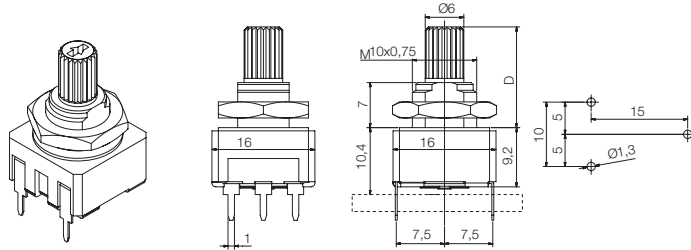

MCA14 V17,5 // MCE14 V17,5

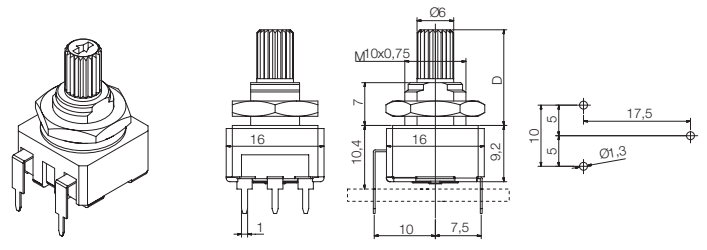

MCA14 VD7,5 // MCE14 VD7,5

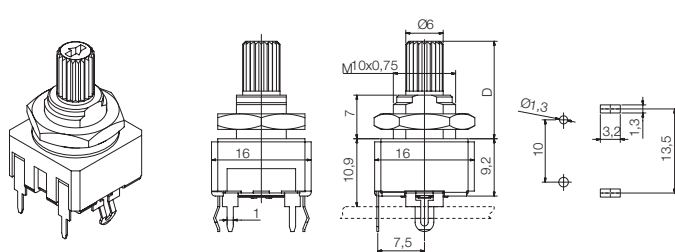

MCA14 VD11 // MCE14 VD11

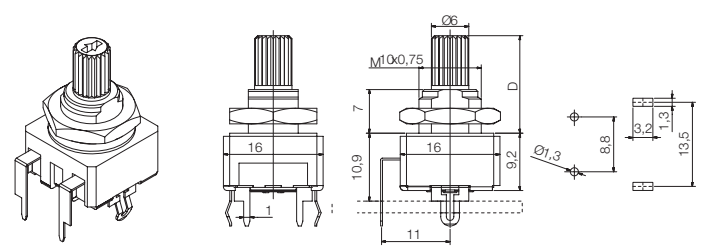

Shafts. MCA14 // MCE14

14008

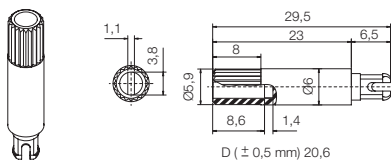

14015

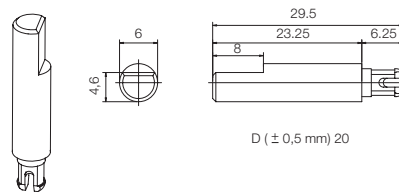

14066

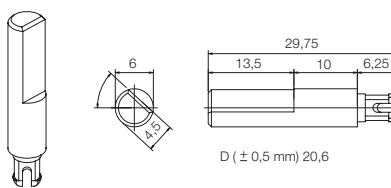

14067

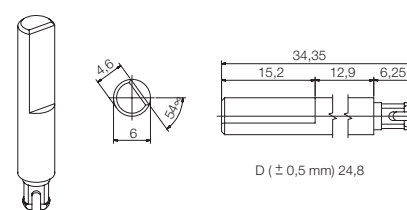

14072

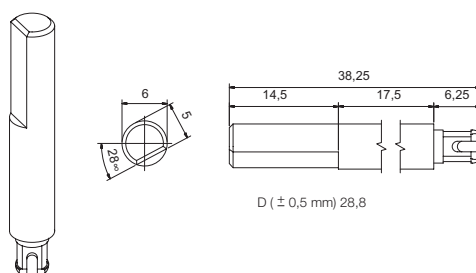

14073

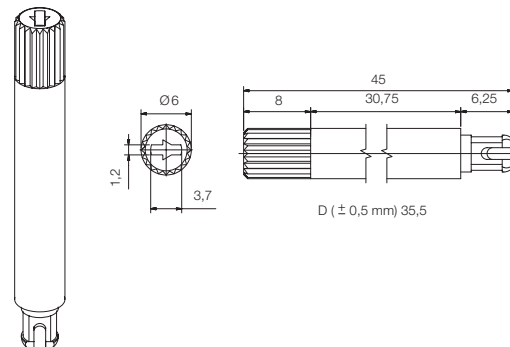

Specifications on this catalogue are for reference only; they are subject to change without notice.

DRAWINGS MCA14 // MCE14

Tolerances 14 mm (in mm.):

<1	±0,1
1...<10	±0,3
10...	±0,5

Shafts. MCA14 // MCE14

14081

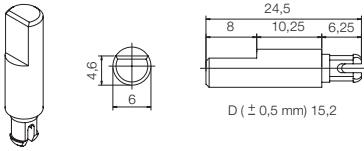

14084

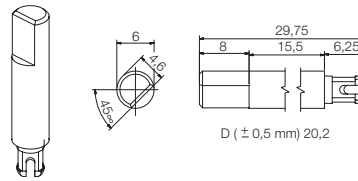

14187

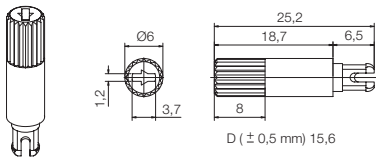

14250

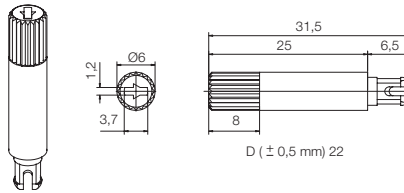

Washer and nut. MCA-14 // MCE-14 // COM MCA-14

WASHER

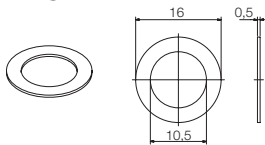

NUT

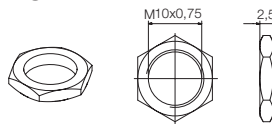

Specifications on this catalogue are for reference only; they are subject to change without notice.