



HESTORE.HU

elektronikai alkatrész áruház

EN: This Datasheet is presented by the manufacturer.

Please visit our website for pricing and availability at www.hestore.hu.



fuse-links & fuse holders

PHOTOVOLTAIC

df PMX-14x51
485252
50A
1000V DC

df NH3
630A 1000V DC
354180
CE
Made in Spain

df
32A 1000V
485150

df NH3 gPV
315 A
1000V DC

I_t = 30 kA
IEC 60269-6
373445

RoHS
COMPLIANT
CE
Made in Spain

df NH1 gPV
100 A
1000V DC

I_t = 30 kA
IEC 60269-6
373245

RoHS
COMPLIANT
CE
Made in Spain

df
10x38
32A
600V DC
I_t = 30 kA

PHOTOVOLTAIC

FUSE-LINKS

- PAGE 04 | gPV 10x38 & 14x51 600 & 1000V DC FUSE-LINKS
- PAGE 05 | gPV 10x85 1200 & 1500V DC FUSE-LINKS
- PAGE 06 | gPV NH1 & NH3 1000V DC FUSE-LINKS

FUSE HOLDERS & BASES

- PAGE 07 | PMX 10x38 & 14x51 1000V DC FUSE HOLDERS
- PAGE 09 | CLIP CONTACT FOR Ø10 FUSE-LINKS
- PAGE 10 | ST NH1 & NH3 1000V DC FUSE BASES

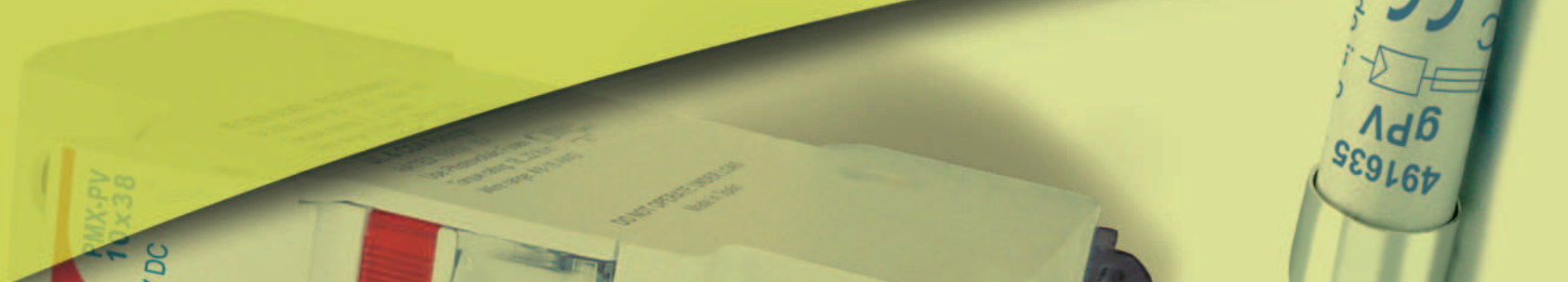

PHOTOVOLTAIC FUSE-LINKS

gPV FUSE-LINKS FOR PHOTOVOLTAIC APPLICATIONS

PV fuse-links for photovoltaic installations from DF Electric have been developed to offer a compact, safety and economic protection solution in photovoltaic installations where, due to the increase of the power and technologic evolution, no-load voltages above 800V DC are reached. Also meet the requirements for instruments (multimeters) and traction equipment auxiliary circuits. The range comprises 10x38 & 14x51 fuse-links with rated currents between 1A and 20A. Rated voltage is 600 V DC or 1000V DC (direct current). Provide protection against overloads as well as short-circuits. Made with ceramic tube with high withstand to internal pressure and thermal shock, that allows a high breaking capacity in a reduced physical space. Contacts are made of silver plated copper and melting elements are made of pure silver in order to avoid the aging and thus keep unalterable the electric characteristics. For these fuse-links we recommend the utilization of PMX 1000V fuse holders in single pole version or two-pole version.

www.df-sa.es/photovoltaic/fuses/

10x38	I _n (A)	REFERENCE	BREAKING CAPACITY (kA)	PACKING Uni./BOX
1000V DC	1	491601	30	10/100
	2	491602	30	10/100
	3	491604	30	10/100
	4	491605	30	10/100
	5	491606	30	10/100
	6	491610	30	10/100
	8	491615	30	10/100
	10	491620	30	10/100
	12	491625	30	10/100
	15	491629	30	10/100
	16	491630	30	10/100
	20	491635	30	10/100



600V DC	1	491901	30	10/100
	2	491902	30	10/100
	3	491904	30	10/100
	4	491905	30	10/100
	5	491906	30	10/100
	6	491910	30	10/100
	8	491915	30	10/100
	10	491920	30	10/100
	12	491925	30	10/100
	15	491929	30	10/100
	16	491930	30	10/100
	20	491935	30	10/100
25	491940	30	10/100	
30	491944	30	10/100	
32	491945	30	10/100	



14x51	I _n (A)	REFERENCE	BREAKING CAPACITY (kA)	PACKING Uni./BOX
1000V DC	25	491650	30	10/50
	32	491655	30	10/50



STANDARDS IEC 60269-1 IEC 60269-6 UL 2579	APPROVALS Cd-Pb FREE RoHS compliant GREEN ELECTRICAL
--	--

TECHNICAL t-I CHARACTERISTICS PAGE 11	TECHNICAL AMBIENT TEMPERATURE DERATING FACTOR PAGE 14
---	--

COMPATIBLE PV FUSE HOLDERS FOR PHOTOVOLTAIC APPLICATIONS PAGE 07	COMPATIBLE CLIP CONTACT FOR Ø10 FUSE-LINKS PAGE 09
--	---

PHOTOVOLTAIC FUSE-LINKS

gPV FUSE-LINKS FOR PHOTOVOLTAIC APPLICATIONS

10x85	I_n (A)	REFERENCE	BREAKING CAPACITY (kA)	PACKING Uni./BOX
1500V DC	2	492202	10	4/24
	4	492205	10	4/24
	6	492210	10	4/24
	8	492215	10	4/24
	10	492220	10	4/24
	12	492225	10	4/24
1200V DC	16	492230	10	4/24
	20	492235	10	4/24
	25	492240	10	4/24



492225

TECHNICAL gPV FUSE-LINKS FOR PHOTOVOLTAIC APPLICATIONS DIMENSIONS

10x38
14x51
10x85

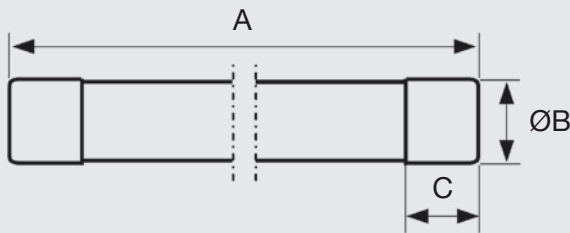

SIZE	A	B	C
10x38	38	10,3	10
14x51	51	14,3	10
10x85	85	10,3	10

STANDARDS
IEC 60269-1
IEC 60269-6
UL 2579

APPROVALS
Cd-Pb FREE
RoHS compliant

TECHNICAL
t-I CHARACTERISTICS
PAGE 12

TECHNICAL
AMBIENT TEMPERATURE
DERATING FACTOR
PAGE 14

COMPATIBLE
CLIP CONTACT FOR $\varnothing 10$
FUSE-LINKS
PAGE 09

PHOTOVOLTAIC FUSE-LINKS

gPV FUSE-LINKS FOR PHOTOVOLTAIC APPLICATIONS

NH

1000V DC

NH gPV 1000V DC fuse-links for photovoltaic installations have been developed to offer a compact, safety and economic protection solution in second level panels of photovoltaic installations. The range comprises NH1 fuse-links with rated currents between 25A and 160A, and NH3 fuse-links with rated currents between 200A and 315 A. Rated voltage is 1000V DC (direct current). They provide protection against overloads as well as short-circuits (gPV class according to IEC 60269 Standard), with a minimum fusing current of $1,35 \cdot I_n$. Made with ceramic body with high withstand to internal pressure and thermal shock. Contacts are made of silver plated copper and melting elements are made of pure silver in order to avoid the aging and thus keep unalterable the electric characteristics. For these fuse-links we recommend the utilization of 1000V NH ST fuse bases.

www.df-sa.es/photovoltaic/fuses/NH/

	I_n (A)	REFERENCE	BREAKING CAPACITY (kA)	PACKING Uni./BOX
NH1	25	373210	30	1/30
	32	373215	30	1/30
	40	373225	30	1/30
	50	373230	30	1/30
	63	373235	30	1/30
	80	373240	30	1/30
	100	373245	30	1/30
	125	373250	30	1/30
	160	373255	30	1/30
NH3	200	373425	30	1/15
	250	373435	30	1/15
	315	373445	30	1/15



TECHNICAL gPV FUSE-LINKS FOR PHOTOVOLTAIC APPLICATIONS DIMENSIONS

NH1

NH3

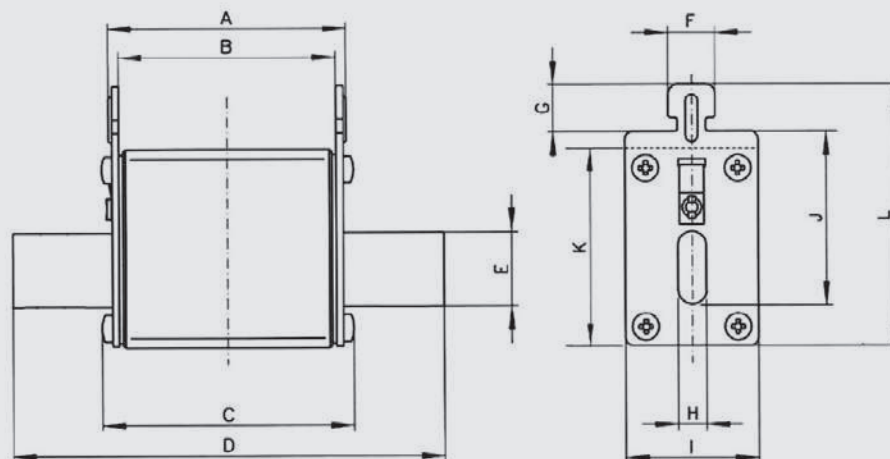

SIZE	A	B	C	D	E	F	G	H	I	J	K	L
NH1	68	62	71,5	135	20	10	9,5	6	39	40	52	64
NH3	68	62	73	150	32	10	9,5	6	70	60	75	87

STANDARDS
IEC 60269-1
IEC 60269-6

APPROVALS
Cd-Pb FREE
RoHS compliant



TECHNICAL
t-I CHARACTERISTICS

PAGE 13

TECHNICAL
AMBIENT TEMPERATURE
DERATING FACTOR

PAGE 14

COMPATIBLE
NH FUSE BASES FOR
PHOTOVOLTAIC
APPLICATIONS

PAGE 10

PHOTOVOLTAIC FUSE HOLDERS

PMX 1000V DC FUSE HOLDERS FOR PHOTOVOLTAIC APPLICATIONS

PMX
1000V
DC

The first feature that PV Modular fuse holders offers, is the 1000V DC rated voltages. They have been developed to offer a compact, safety and economic protection solution in photovoltaic installations where due to the increase of the power and technologic evolution, no-load voltages above 800V DC can be achieved. Modular fuse holders for 10x38 & 14x51 gPV fuses according IEC/EN 60269 standard. Compact design, with reduced distances. Manufactured with a high quality materials: Silver plated copper contacts and plastic materials with high temperature resistance and selfextinguishable. All the materials are according to the European Directive 2002/95/EC RoHS (Restriction of the use of certain hazardous substances in electrical material).

www.df-sa.es/photovoltaic/fuseholders-and-fusebases/fuseholders/

	POLES	MODULES	REFERENCE	DESCRIPTION	I_n (A)	U (V DC)	PACKING Uni./BOX
10x38	1	1	485150	SINGLE-POLE	32	1000	12/192
	2	2	485151	TWO-POLES	32	1000	6/96
WITH INDICATOR	1	1	485152	SINGLE-POLE	32	1000	12/192
	2	2	485153	TWO-POLES	32	1000	6/96
14x51	1	1,5	485250	SINGLE-POLE	50	1000	6/90
	2	3	485251	TWO-POLES	50	1000	3/45
WITH INDICATOR	1	1,5	485252	SINGLE-POLE	50	1000	6/90
	2	3	485253	TWO-POLES	50	1000	3/45



STANDARDS	APPROVALS
IEC 60269-1 IEC 60269-2 IEC 60947-3 EN 60269-1 EN 60269-2 EN 60947-3	RoHS compliant

COMPATIBLE	COMPATIBLE
gPV FUSE-LINKS FOR PHOTOVOLTAIC APPLICATIONS	CONNECTION ACCESSORIES: PHASE BUSBARS AND ACCESSORIES
PAGE 04	SEE CYLINDRICAL

PHOTOVOLTAIC FUSE BASES

TECHNICAL
PV FUSE HOLDERS FOR PHOTOVOLTAIC APPLICATIONS
DIMENSIONS

10x38

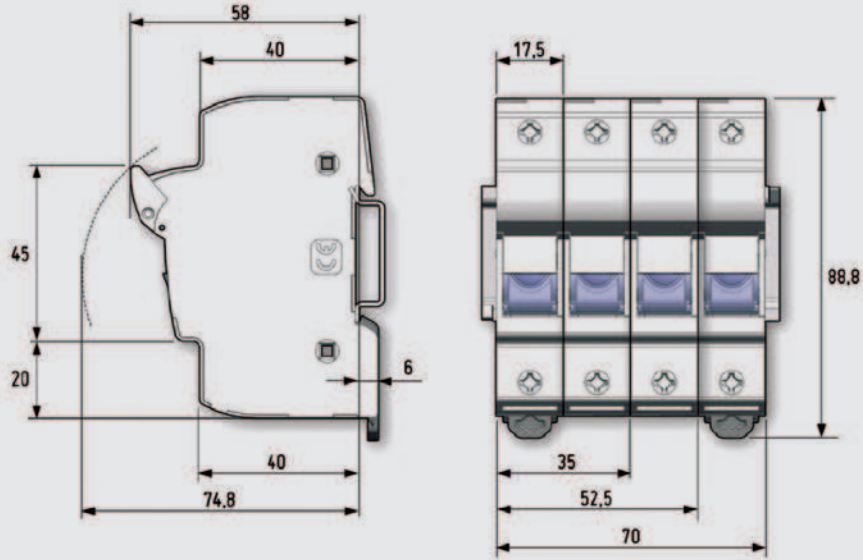

TECHNICAL
PV FUSE HOLDERS FOR PHOTOVOLTAIC APPLICATIONS
DIMENSIONS

14x51

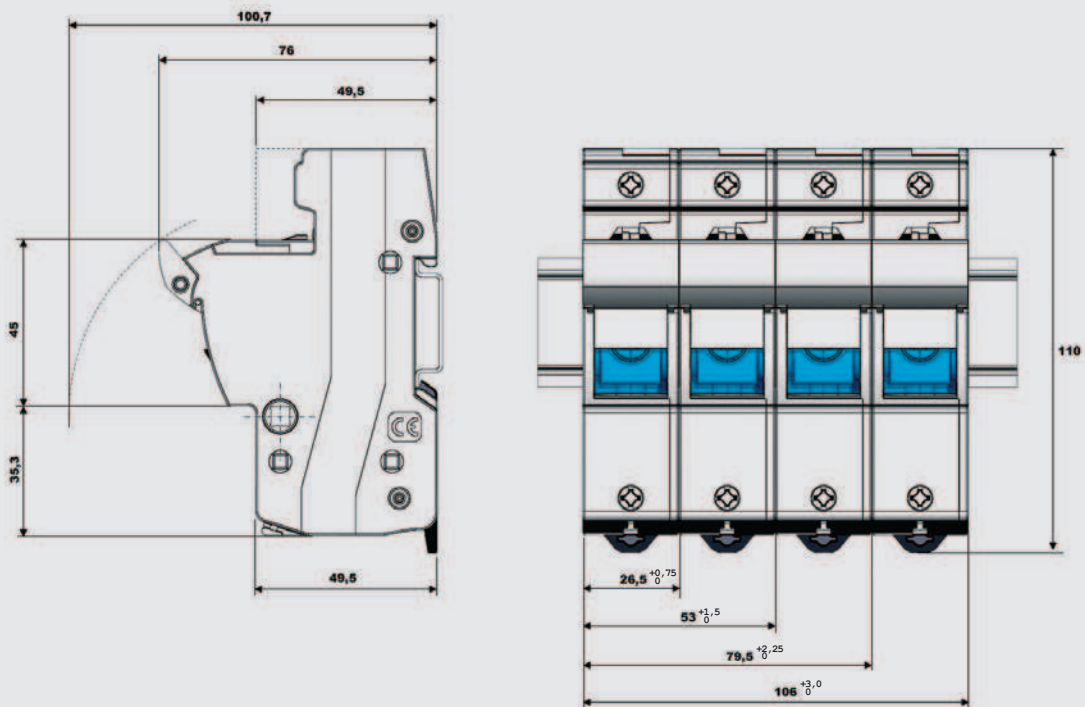

PHOTOVOLTAIC FUSE BASES

NEW

CLIP CONTACT FOR Ø10 FUSE-LINKS

Clip contact for Ø10 cylindrical fuse links. Screw fixation and PCB versions. Manufactured in tinned bronze. All the materials are according to the European Directive 2002/95/EC RoHS (Restriction of the use of certain hazardous substances in electrical material).

10x38
10x85

REFERENCE	DESCRIPTION	I_n (A)	P_d max (W)	PACKING Uni./BOX
482001	Ø10 CLIP CONTACT SCREW FIXATION	25	4	50/200
482002	Ø10 CLIP CONTACT FOR PCB	25	4	50/200



482001



482002

TECHNICAL
10x38
10x85

CLIP CONTACT FOR Ø10 FUSE-LINKS DIMENSIONS

Ø10 CLIP CONTACT SCREW FIXATION

SIZE	L (mm)
10x38	32
10x85	79,6

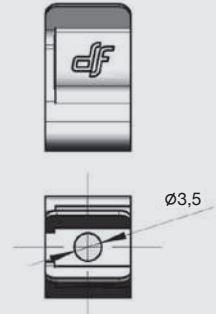
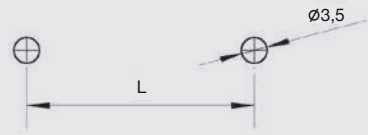

Ø10 CLIP CONTACT FOR PCB

SIZE	L (mm)
10x38	42
10x85	89,6

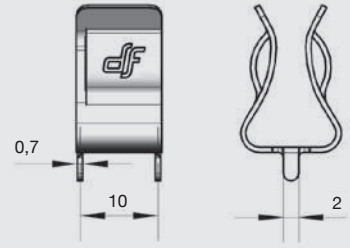
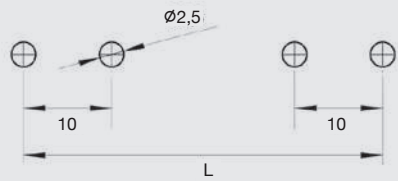

PHOTOVOLTAIC FUSE BASES

NEW

ST 1000V DC NH FUSE BASES FOR PHOTOVOLTAIC APPLICATIONS

Fuse bases for NH fuse-links. Available in sizes NH1(250 A) and NH3(630 A). Manufactured with a high quality materials. Silver plated copper contacts. Plastic materials with high temperature resistance and self-extinguishable. All the materials are according to the European Directive 2002/95/EC RoHS. For DIN rail mounting or with screw fixing. Single-phase type. Connection by screws. Contacts with double spring in order to obtain an optimum operation. Wide range of accessories that enables IP20 protection index: contact covers, fuse link covers and partition walls. Multi-pole units can be made with connection accessories. Manufactured according IEC, VDE and DIN standards.

www.df-sa.es/photovoltaic/fuseholders-and-fusebases/fusebases/



354170



354180



357000

	DESCRIPTION	REFERENCE	U (VDC)	PACKING
SINGLE POLE				
NH1 250A	DIN RAIL-SCREW FIXING / SCREW CONNECTION	354170	1000	1
NH3 630A	DIN RAIL-SCREW FIXING / SCREW CONNECTION	354180	1000	1

NH FUSE BASES ACCESSORIES MICROSWITCHES FOR NH LINKS

SIZE	REFERENCE	DESCRIPTION	PACKING
NH1 NH3			Uni./BOX
CLASS 1	357000	MICROSWITCH FOR NH1 & NH3 FUSE-LINKS	1/100

TECHNICAL ST 1000V DC NH FUSE BASES FOR PHOTOVOLTAIC APPLICATIONS DIMENSIONS

NH1 250A

NH3 630A

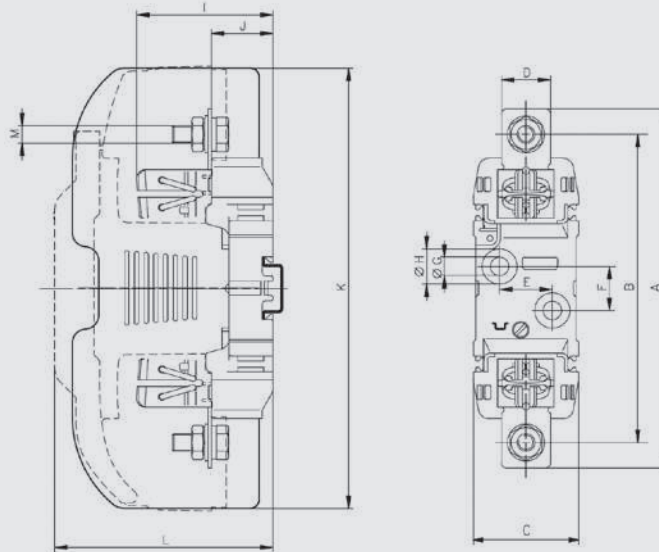

SIZE	A	B	C	D	E	F	G	H	I	J	K	L	M
NH1	200	175	60	28	30	25	10,5	20,5	77,5	35	250	123	M10
NH3	240	210	60	38	30	25	10,5	20,5	97	35	270	143	M12

STANDARDS
IEC 60269-1
IEC 60269-2
EN 60269-1
EN 60269-2

STANDARDS
VDE 0636
DIN 43620

APPROVALS
RoHS compliant

COMPATIBLE
gPV NH1 & NH3 FUSE-LINKS FOR PHOTOVOLTAIC APPLICATIONS
PAGE 06

COMPATIBLE
TERMINAL COVERS, FUSE-LINKS COVERS AND IP20 PROTECTION KITS
SEE NH

TECHNICAL **gPV** FUSE-LINKS FOR PHOTOVOLTAIC APPLICATIONS
t-I CHARACTERISTICS & POWER DISSIPATION

10x38

14x51

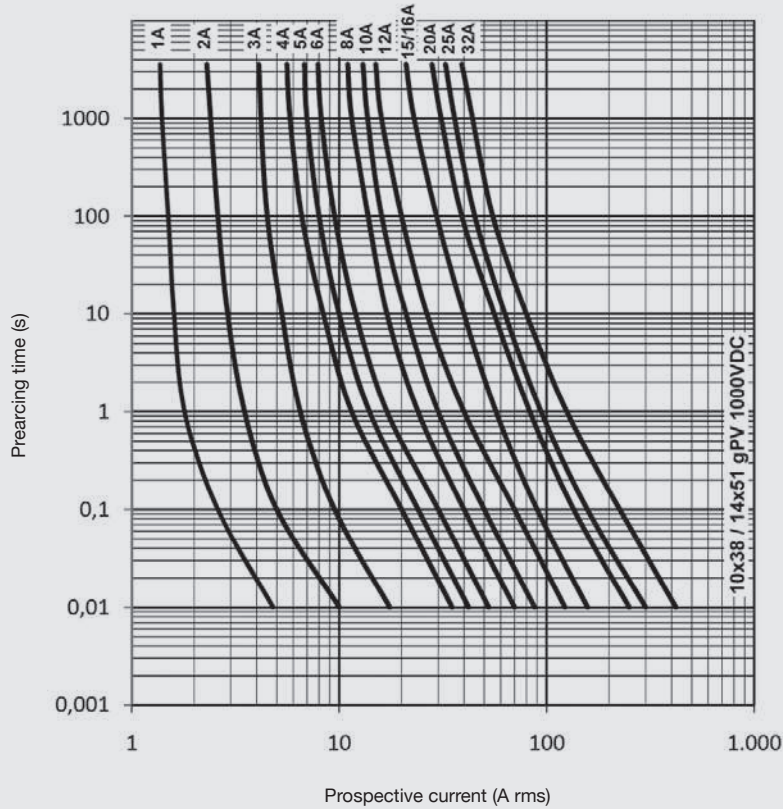

RATED CURRENT (A)	REFERENCE		POWER DISSIPATION (W @ 0.7 I _n)		POWER DISSIPATION (W @ I _n)		PREARcing I ² t (A ² s)		OPERATING I ² t (A ² s)	
	1000V DC	600V DC	1000V DC	600V DC	1000V DC	600V DC	1000V DC	600V DC	1000V DC	600V DC
1	491601	491901	0,31	0,31	0,76	0,76	0,35	0,35	1,3	0,8
2	491602	491902	0,78	0,62	1,45	1,54	0,62	1,78	1,0	3,9
3	491604	491904	0,66	0,54	1,66	1,35	1,9	9,0	3,1	19,6
4	491605	491905	0,64	0,73	1,57	1,84	6,9	3,0	11	6,6
5	491606	491906	0,60	0,93	1,65	2,22	14	4,4	22	9,6
6	491610	491910	0,76	0,96	1,84	2,40	24	8,5	38	18,8
8	491615	491915	0,80	1,02	1,92	2,55	62	25	99	55,0
10	491620	491920	0,94	1,03	2,2	2,58	10	11	48	27,9
12	491625	491925	0,98	1,04	2,4	2,60	18	25	94	62,8
15	491629	491929	1,0	1,07	2,6	2,44	46	25	110	82,8
16	491630	491930	1,1	1,08	2,7	2,70	46	33	110	82,8
20	491635	491935	1,2	1,16	2,9	2,90	118	85	282	212
25	-	491940	-	1,10	-	2,74	-	280	-	460
30	-	491944	-	1,70	-	4,00	-	400	-	650
32	-	491945	-	1,76	-	4,40	-	400	-	650

10x38

14x51

1	491650	-	1,6	-	3,8	-	275	-	650	-
2	491655	-	2,0	-	4,7	-	550	-	1300	-

PHOTOVOLTAIC FUSE-LINKS

TECHNICAL

gPV FUSE-LINKS FOR PHOTOVOLTAIC APPLICATIONS t-I CHARACTERISTICS & POWER DISSIPATION

10x85

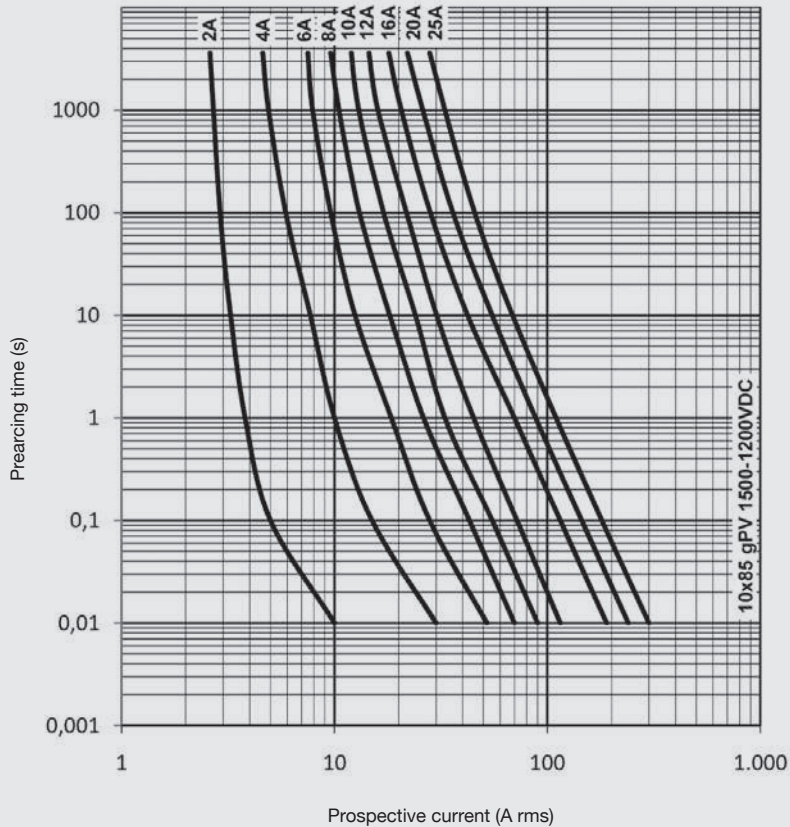

	RATED CURRENT (A)	REFERENCE	POWER DISSIPATION (W @ 0,7 In)	POWER DISSIPATION (W @ In)	PREARcing I ² t (A ² s)	OPERATING I ² t (A ² s)
1500V DC	2	492202	1,28	3,42	0,8	1,1
	4	492205	1,16	2,91	13	17
	6	492210	1,10	2,65	65	84
	8	492215	1,16	2,79	175	225
	10	492220	1,81	4,38	209	269
	12	492225	1,83	4,43	400	515
1200V DC	16	492230	1,75	4,13	136	269
	20	492235	2,13	5,14	242	478
	25	492240	2,28	5,48	545	1075

TECHNICAL **gPV** FUSE-LINKS FOR PHOTOVOLTAIC APPLICATIONS
t-I CHARACTERISTICS & POWER DISSIPATION

NH1

NH3

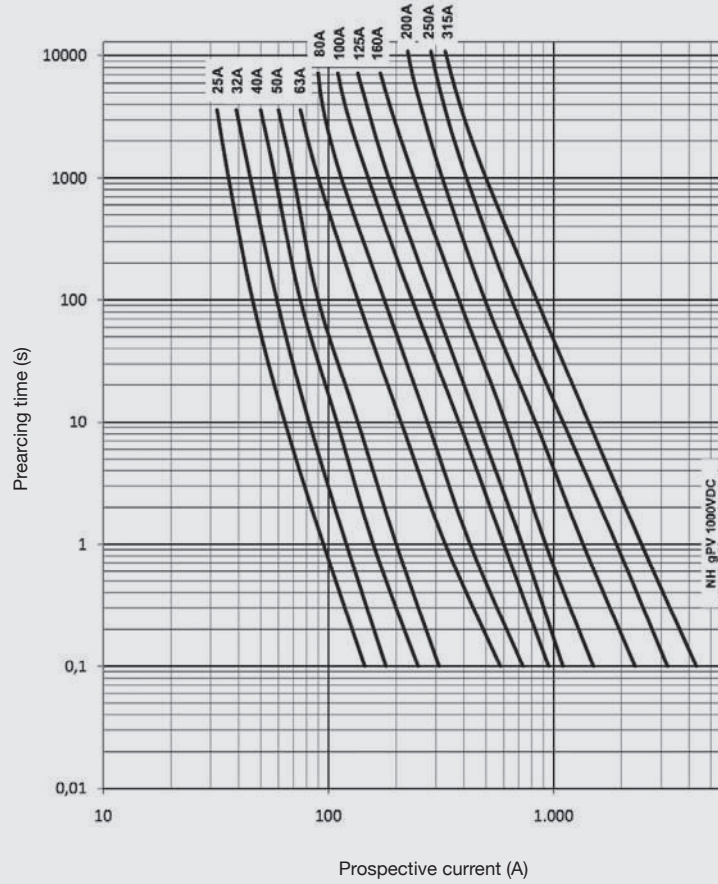

	RATED CURRENT (A)	REFERENCE	POWER DISSIPATION (W @ 0,7In)	POWER DISSIPATION (W @ In)	PREARCING I ² t (A ² s)	OPERATING I ² t (A ² s)
		1000V DC	1000V DC	1000V DC	1000V DC	1000V DC
NH1	25	373210	5,2	12,5	62	94
	32	373215	6,3	15,5	122	184
	40	373225	6,7	16,6	302	454
	50	373230	7,5	18	562	844
	63	373235	8,2	20	1210	1815
	80	373240	10	27	2250	3375
	100	373245	11	28	4000	6000
	125	373250	12,5	32	6500	9700
	160	373255	13,5	34,0	9200	16600
NH3	200	373425	19,5	48,0	21700	31700
	250	373435	20,5	51,5	41000	60000
	315	373445	26,2	66,0	76000	111500

PHOTOVOLTAIC FUSE-LINKS

TECHNICAL **gPV** FUSE-LINKS FOR PHOTOVOLTAIC APPLICATIONS
 AMBIENT TEMPERATURE DERATING FACTOR

10x38
14x51

10x38
14x51

10x85

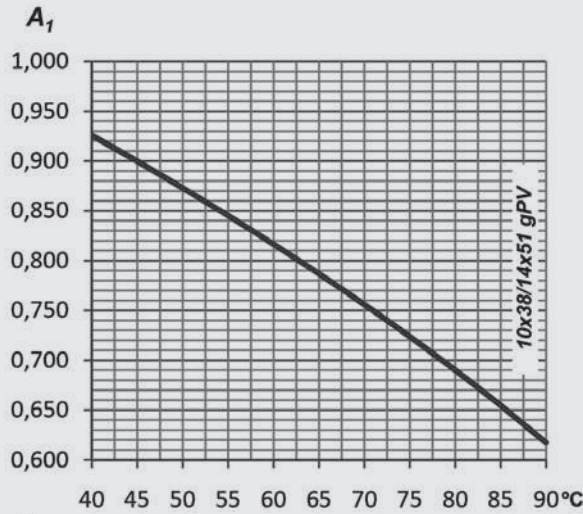

t_a (°C)	A_1
40	0,92
45	0,90
50	0,87
55	0,85
60	0,82
65	0,79
70	0,76
75	0,72
80	0,69

10x85

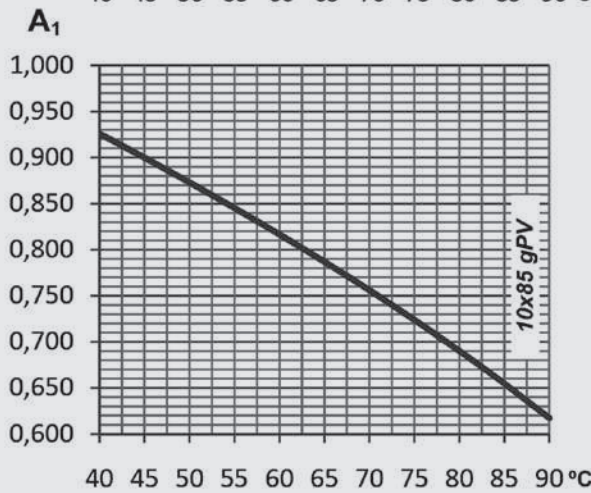

t_a (°C)	A_1
40	0,92
45	0,90
50	0,87
55	0,85
60	0,82
65	0,79
70	0,76
75	0,72
80	0,69

TECHNICAL **gPV** FUSE-LINKS FOR PHOTOVOLTAIC APPLICATIONS
 AMBIENT TEMPERATURE DERATING FACTOR

NH1

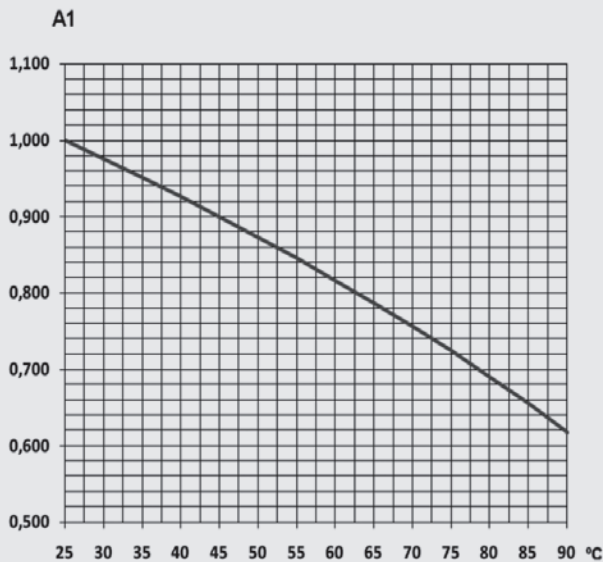

t_a (°C)	A_1
40	0,92
45	0,90
50	0,87
55	0,85
60	0,82
65	0,79
70	0,76
75	0,72
80	0,69

Electric

THE PROTECTION FORMULA

ELECTRONIC



CYLINDRICAL



PHOTOVOLTAIC



RAPIDPLUS



NH



SPECIAL FUSES



DOMESTIC



D & DO



TRANSFORMERS



eXperts in
PROTECTION



HEAD OFFICE & FACTORY

SILICI, 67-69

08940 CORNELLA DE LLOBREGAT

BARCELONA

SPAIN

Tel. +34 93 377 85 85

Fax +34 93 377 82 82

EXPORT SALES

Tel. +34 93 475 08 64

Fax +34 93 480 07 75

export@df-sa.es

NATIONAL SALES

Tel. 93 475 08 64

Fax 93 480 07 76

comercial@df-sa.es

www.df-sa.es/photovoltaic