



HESTORE.HU

elektronikai alkatrész áruház

EN: This Datasheet is presented by the manufacturer.

Please visit our website for pricing and availability at www.hestore.hu.



TH Origin/Elite

User manual V1.1

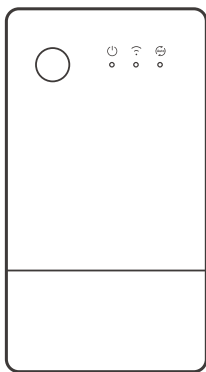

TH Origin

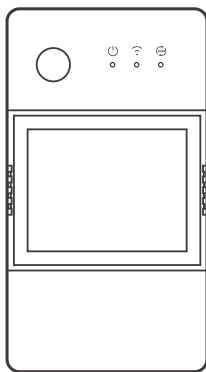

TH Elite

Smart Temperature and Humidity Monitoring Switch

产品介绍

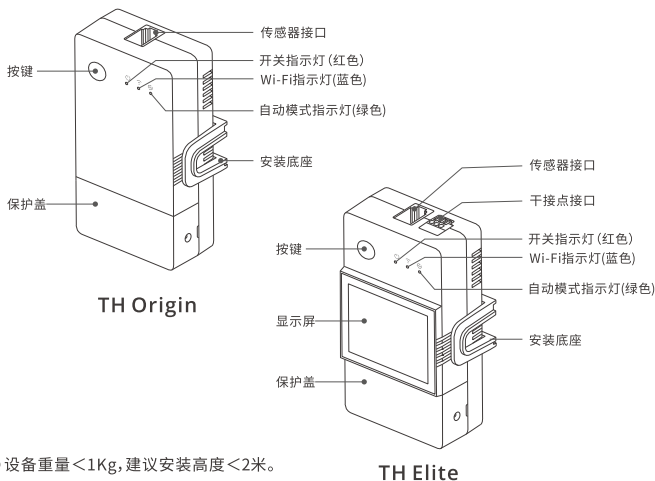

按键功能

动作	结果
单击	设备开/关
双击	自动模式开启/关闭
长按5秒	进入配网模式

信号指示灯状态说明

指示灯状态	状态说明
蓝灯两短一长闪烁	配网模式
蓝灯常亮	设备在线
蓝灯快闪一下	未连接路由
蓝灯快闪二下	已连接上路由器, 但未连接到云端
蓝灯快闪三下	固件升级中
绿灯常亮	自动模式开启

功能特点

TH Origin/Elite是一款带温湿度检测的智能开关改装件，需连接配套的温湿度传感器一起使用。



温度和湿度监测



温度和湿度历史数据



自动模式



分享控制



点动模式



语音控制



智能定时/延时



局域网功能



干接点
(TH Elite)



屏幕显示
(TH Elite)

设备安装

1. 断电

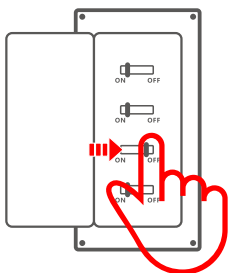

⚠ 设备安装、故障维修请由专业资质电工操作。切勿在设备通电时进行接线操作或触碰到接线端子，以免发生触电危险！

2. 接线

2-1 取下保护盖

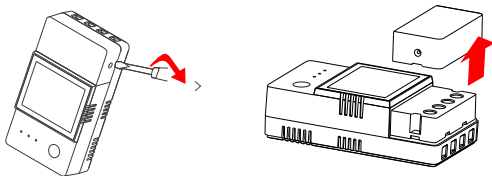

2-2

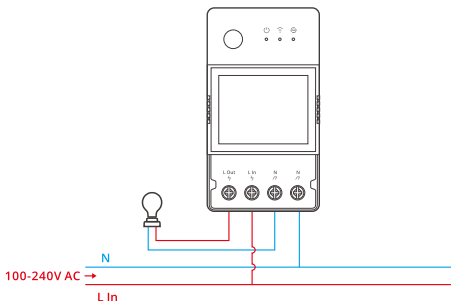

2-3 干接点接线方法

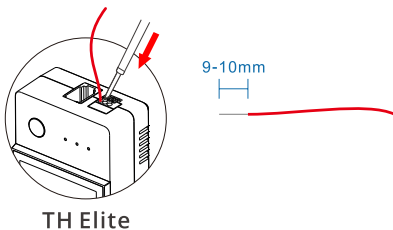

按下接线孔对应上方的白色按钮同时将线材插入，松开按钮即可。

⚠ 干接点接线线材单根线径范围 $0.13-0.5\text{mm}^2$ ，剥线长度：9-10mm。

⚠ 确保线路接入无误。

3. 插入传感器

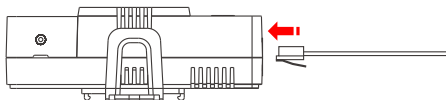

兼容的SONOFF传感器：DS18B20, MS01, THS01, AM2301, Si7021。

兼容的传感器延长线：RL560。

⚠ 部分老版本传感器需与附赠的转接头一起使用。

设备配对

1. 下载“易微联”App



2. 上电

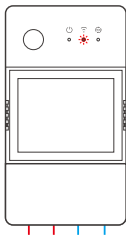

通电后，设备首次使用，默认进入配网模式。Wi-Fi指示灯呈“两短一长闪烁”。

⚠ 3分钟内没有进行配网，设备将退出蓝牙配网模式。如需再次进入，长按设备按键5秒直到Wi-Fi指示灯呈两短一长闪烁即可。

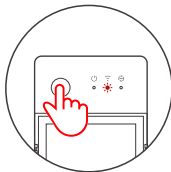

3. 添加设备

方法1: 蓝牙配对

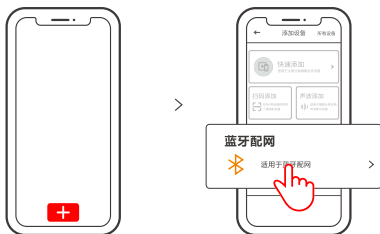

点击“+”，选择“蓝牙配对”，再根据 App 提示进行操作。

方法2: 扫码添加



在配网模式下, 选择“扫码添加”, 扫描设备背面的二维码进行配对。

Alexa 语音控制教程

1. 下载 Alexa App 并登录账号。



2. 在 Alexa App 中添加 Echo 音箱

3. 账号关联 (从 eWeLink App 中关联 Alexa 账号)

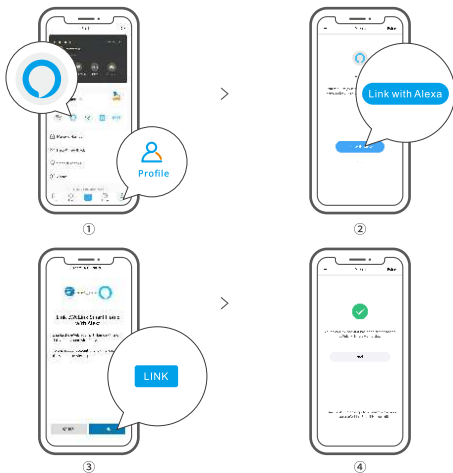

4. 关联完成后, 再根据 Alexa App 提示完成发现设备。

ⓘ Google Assistant、小度、天猫精灵、小爱同学的语音控制绑定方式类似, 具体请参考App上的说明。

产品参数

产品型号	THR316, THR320, THR316D, THR320D
输入	THR316, THR316D: 100-240V ~ 50/60Hz 16A Max THR320, THR320D: 100-240V ~ 50/60Hz 20A Max
输出	THR316, THR316D: 100-240V ~ 50/60Hz 16A Max THR320, THR320D: 100-240V ~ 50/60Hz 20A Max
干接点输出	5-30V, 1A Max
Wi-Fi	IEEE 802.11 b/g/n 2.4GHz
屏幕显示大小	THR316D, THR320D: 43x33mm
App支持系统	Android & iOS
工作温度	-10°C~40°C
工作湿度	5%-95%RH,无冷凝
外壳材料	PC V0
产品规格	THR316, THR320: 98x54x27.5mm THR316D, THR320D: 98x54x31mm

局域网控制

手机与设备连接同一个WiFi, 不通过云平台, 直接对设备进行控制的通讯方式。

- ⊕ 无外网连接时, 不支持新增定时、延时、循环定时、操作通知、操作记录、固件升级、智能场景、分享设备、删除设备。

控制模式

手动模式: 随时通过 App、设备按键等方式控制设备开关

自动模式: 通过设定的温度或湿度阈值自动地控制设备开关

- ⊕ 自动模式设置:

设置温室/湿度阈值及生效时间段, 最多可设置8个不同时间段的自动控制程序。

自动模式开启/关闭

双击设备上按键或在App中启用/关闭

- ⊕ 手动控制与自动控制模式同时存在, 没有优先级。自动模式下能手动控制开关, 一段时间后, 自动模式检测到温湿度变化, 会恢复执行。

恢复出厂设置

在 eWeLink App 端“删除设备”，设备即恢复出厂设置。

常见问题

Wi-Fi设备与 eWeLink APP 配对失败。

1. 确保设备处于配对模式。三分钟内没进行配网,设备将自动退出配对模式。
2. 请开启定位服务并允许定位权限。在选择 Wi-Fi 网络之前,请开启定位服务并允许定位权限。位置信息权限用于获取 Wi-Fi 列表信息。如果单击禁用,您将无法添加设备。
3. 确保您的 Wi-Fi 网络为 2.4GHz 频段。
4. 确保您输入了正确的 Wi-Fi SSID 和密码,没有包含特殊字符。密码错误是配对失败的一个非常常见的原因。
5. 配对时设备应靠近路由器,以保证良好的传输信号条件。

Wi-Fi 设备“离线”问题,请通过 Wi-Fi LED 指示灯状态检查以下问题:

LED 指示灯每 2 秒闪烁一次,表示您无法连接到路由器。

1. 可能您输入了错误的 Wi-Fi SSID 和密码。
2. 确保您的 Wi-Fi SSID 和密码不包含特殊字符,例如希伯来语、阿拉伯语字符,我们的系统无法识别这些字符,因此无法连接到 Wi-Fi。
3. 可能你的路由器承载能力较低。
4. 可能是 Wi-Fi 强度较弱。您的路由器距离您的设备太远,或者路由器和设备之间可能存在阻碍信号传输的障碍物。
5. 确保设备的 MAC 不在您的 MAC 管理黑名单中。

LED 指示灯重复闪烁两次表示您无法连接到服务器。

1. 确保互联网连接正常。您可以使用您的手机或PC连接互联网,如果无法访问,请检查互联网连接的可用性。
2. 可能你的路由器承载能力低。连接到路由器的设备数量超过其最大值。请确认您的路由器可以携带的最大设备数量。如果超过,请删除一些设备或换个更大的路由器再试。
3. 请联系您的 ISP 并确认我们的服务器地址没有被屏蔽:
cn-disp.coolkit.cc (中国大陆)
as-disp.coolkit.cc (亚洲除中国外)
eu-disp.coolkit.cc (在欧盟)
us-disp.coolkit.cc (美国)

如果以上方法均无法解决此问题,请通过 eWeLink APP 上的帮助&反馈提交您的请求。

Product Introduction

TH Origin

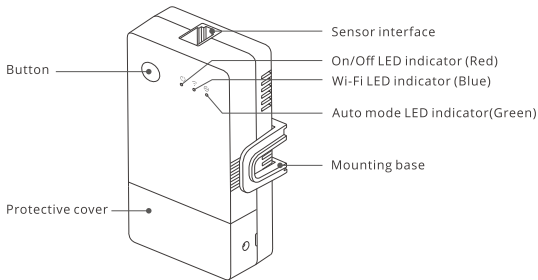

TH Elite

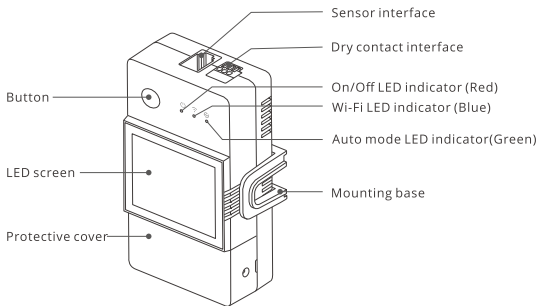

- ⚠ The device weight is less than 1kg.
The installation height of less than 2m is recommended.

Buttons instructions

Actions	Results
Single-click	Device on/off
Double-click	Auto-mode enable/disable
Long press for 5s	Enter the Pairing mode

LED indicator status instruction

LED indicator status	Status instruction
Blue LED indicator flashes(one long and two short)	Pairing mode
Blue LED indicator keeps on	Device is online
Blue LED indicator quick flashes once	Fail to connect to router
Blue LED indicator quick flashes twice	Connected to router but fail to connect to server
Blue LED indicator quick flashes three times	Firmware updating
Green LED indicator keeps on	Auto-mode is on

Features

TH Origin/Elite is a DIY smart switch with temperature and humidity monitoring, and required to use with the temperature and humidity sensors correspondingly.



Temp & Humi
Monitoring



Temp & Humi
History Data Graph



Automatic Mode



Share Control



Inching Mode



Voice Control



Timer Schedule



LAN Control



Wet & Dry Contact
(TH Elite)



Screen Display
(TH Elite)

Device Installation

1. Power off

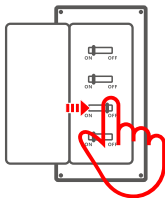

⚠ Please install and maintain the device by a professional electrician. To avoid electric shock hazard, do not operate any connection or contact the terminal connector while the device is powered on!

2. Wiring instruction

2-1 Remove protective cover

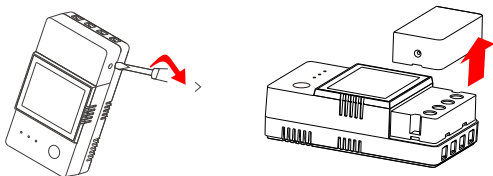

2-2

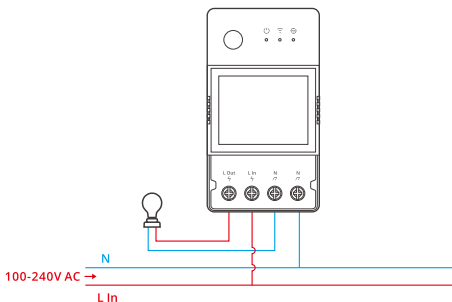

2-3 Wiring method of dry contact

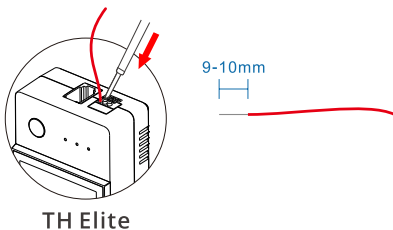

Press the white button on the top of the wire connecting hole to insert the wire corresponding, then release.

⚠ Dry contact wire conductor size: 0.13-0.5mm², wire stripping length: 9-10mm.

⚠ Make sure all wires are connected correctly.

3. Insert the sensor

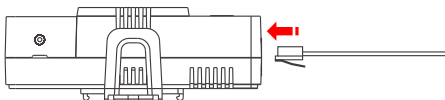

Compatible SONOFF sensors: DS18B20, MS01, THS01, AM2301, SI7021.
Compatible sensor extension cables: RL560.

⚠ Some old version sensors need to be used with the accompanying adapter.

Device pairing

1. Download the eWeLink App

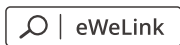

Android™ & iOS

2. Power on

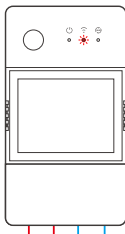

After powering on, the device will enter the Bluetooth Pairing Mode during the first use. The Wi-Fi LED indicator changes in a cycle of two short and one long flash and release.

- ⓘ The device will exit the Bluetooth Pairing Mode if not paired within 3mins. If you want to enter this mode, please long press button for about 5s until the Wi-Fi LED indicator changes in a cycle of two short and one long flash and release.

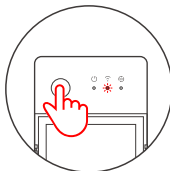

3. Add device

Method 1: Bluetooth Pairing

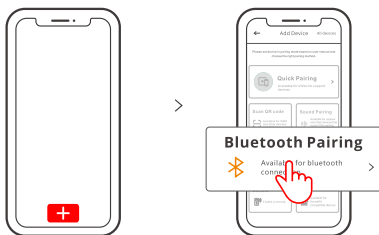

Tap "+" and select "Bluetooth Pairing", then operate following the prompt on the App.

Method 2: Scan QR code

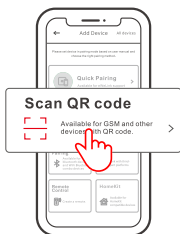

In the Pairing mode, tap "Scan QR code" to add the device by scanning the QR code on its back.

Alexa voice control instructions

1. Download the Amazon Alexa App and sign up an account.



Amazon Alexa

2. Add Amazon Echo Speaker on the Alexa App.

3. Account Linking (Link Alexa account on the eWeLink App)

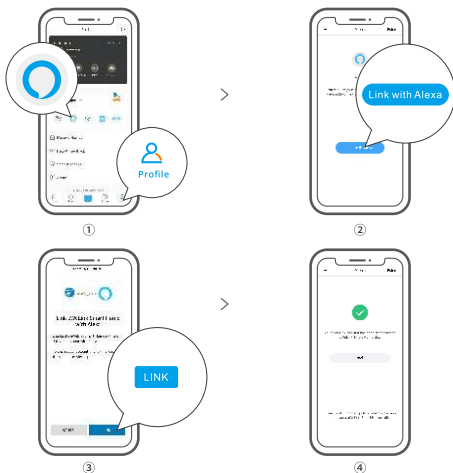

4. After linking the accounts, you can discover devices to connect on the Alexa App according to the prompt.

ⓘ Account linking method of Google Assistant, Xiaodu, Tmall Genie, Mate Xiaoai and etc is similar., the guides on the App shall prevail.

Specifications

Model	THR316, THR320, THR316D, THR320D
Input	THR316, THR316D: 100-240V ~ 50/60Hz 16A Max THR320, THR320D: 100-240V ~ 50/60Hz 20A Max
Output	THR316, THR316D: 100-240V ~ 50/60Hz 16A Max THR320, THR320D: 100-240V ~ 50/60Hz 20A Max
Dry contact output	5-30V, 1A Max
Wi-Fi	IEEE 802.11 b/g/n 2.4GHz
LED screen size	THR316D, THR320D: 43x33mm
App supported systems	Android & iOS
Working temperature	-10°C~40°C
Working humidity	5%-95% RH, non-condensing
Shell material	PC V0
Dimension	THR316, THR320: 98x54x27.5mm THR316D, THR320D: 98x54x31mm

LAN control

A communication method to control the devices directly without going through the Cloud, which requires your smartphone and device connect to the same WIFI.

⚠ Operation notifications, operation records, firmware upgrades, smart scenes, devices sharing and devices delete are not supported when there is no external network connection.

Control modes

Manual mode: Turn on/off the device through the App and device itself whenever you want.

Auto mode: Turn on/off the device automatically through presetting the threshold of temperature and humidity.

⚠ **Auto mode setting:** Set the threshold of temperature & humidity and effective time period, you can set up 8 automatic control programs in different time periods

Auto mode enable/disable

Enable/disable the auto mode by double click the button on the device or enable/disable it on the App directly.

- ⓘ Manual control and Auto mode can work at the same time. In the auto mode, you can turn on/off the device manually. After a while, auto mode will resume execution if it detects changes in temperature and humidity.

Factory Reset

Deleting the device on the eWeLink app indicates you restore it to factory setting.

Common Problems

Fail to pair Wi-Fi devices to eWeLink APP

1. Make sure the device is in pairing mode. After three minutes of unsuccessful pairing, the device will automatically exit pairing mode.
2. Please turn on location services and allow location permission. Before choosing the Wi-Fi network, location services should be turned on and location permission should be allowed. Location information permission is used to obtain Wi-Fi list information. If you click Disable, you will not be able to add devices.
3. Make sure your Wi-Fi network runs on the 2.4GHz band.
4. Make sure you entered a correct Wi-Fi SSID and password, no special characters contained. Wrong password is a very common reason for pairing failure.
5. The device shall get close to the router for a good transmission signal condition while pairing.

Wi-Fi devices "Offline" issue, Please check the following problems by the Wi-Fi LED indicator status:

The LED indicator blinks once every 2s means you fail to connect to the router.

1. Maybe you entered the wrong Wi-Fi SSID and password.
2. Make sure that your Wi-Fi SSID and password don't contain special characters, for example, the Hebrew, Arabic characters, our system can't recognize these characters and then fail to connect to the Wi-Fi.
3. Maybe your router has a lower carrying capacity.
4. Maybe the Wi-Fi strength is weak. Your router is too far away from your device, or there may be some obstacle between the router and device which blocks the signal transmission.
5. Be sure that the MAC of the device is not on the blacklist of your MAC management.

The LED indicator flashes twice on repeated means you fail to connect to the server.

1. Make sure the Internet connection is working. You can use your phone or PC to connect to the Internet, and if it fails to access, please check the availability of the Internet connection.
2. Maybe your router has a low carrying capacity. The number of devices connected to the router exceeds its maximum value. Please confirm the maximum number of devices that your router can carry. If it exceeds, please delete some devices or get a larger router and try again.
3. Please contact your ISP and confirm our server address is not shielded:
cn-disp.coolkit.cc (China Mainland)
as-disp.coolkit.cc (in Asia except China)
eu-disp.coolkit.cc (in EU)
us-disp.coolkit.cc (in US)

If none of the above methods solved this problem, please submit your request via help&feedback on the eWeLink App.

FCC Warning

Changes or modifications not expressly approved by the party responsible for compliance could avoid the user's authority to operate the equipment.

This device complies with part 15 of the FCC Rules. Operation is subject to the following two conditions: (1) This device may not cause harmful interference, and (2) this device must accept any interference received, including interference that may cause undesired operation.

FCC Radiation Exposure Statement:

This equipment complies with FCC radiation exposure limits set forth for an uncontrolled environment. This equipment should be installed and operated with minimum distance 20cm between the radiator & your body. This transmitter must not be co-located or operating in conjunction with any other antenna or transmitter.

Note:

This equipment has been tested and found to comply with the limits for a Class B digital device, pursuant to part 15 of the FCC Rules. These limits are designed to provide reasonable protection against harmful interference in a residential installation. This equipment generates, uses and can radiate radio frequency energy and, if not installed and used in accordance with the instructions, may cause harmful interference to radio communications. However, there is no guarantee that interference will not occur in a particular installation. If this equipment does cause harmful interference to radio or television reception, which can be determined by turning the equipment off and on, the user is encouraged to try to correct the interference by one or more of the following measures:

- Reorient or relocate the receiving antenna.
- Increase the separation between the equipment and receiver.
- Connect the equipment into an outlet on a circuit different from that to which the receiver is connected.
- Consult the dealer or an experienced radio/TV technician for help.

Hereby, Shenzhen Sonoff Technologies Co., Ltd. declares that the radio equipment type THR316, THR320, THR316D, THR320D are in compliance with Directive 2014/53/EU. The full text of the EU declaration of conformity is available at the following internet address:

<https://sonoff.tech/usermanuals>

SONOFF

Shenzhen Sonoff Technologies Co., Ltd.

3F & 6F, Bldg A, No. 663, Bulong Rd, Shenzhen, Guangdong, China
ZIP code: 518000 Website: sonoff.tech

MADE IN CHINA

