



HESTORE.HU

elektronikai alkatrész áruház

EN: This Datasheet is presented by the manufacturer.

Please visit our website for pricing and availability at www.hestore.hu.

Features and Benefits

- The control integrated circuit and the LED share the only power source.
- **12mA** operating current per channel.
- Control circuit and RGB chip are integrated in a package of **2020** components, to form a complete addressable pixel.
- Built-in signal reshaping circuit, after wave reshaping to the next driver, ensure wave-form distortion not accumulate.
- Built-in electric reset circuit and power lost reset circuit.
- Each pixel of the three primary color can achieve 256 brightness display, completed 16777216 color full color display, and scan frequency is of **2KHz**.
- Cascading port transmission signal by single line.
- Any two point the distance not more than 3m transmission signal without any increase circuit.
- When the refresh rate is 30fps, cascade number are not less than 1024 pixels.
- Send data at speeds of 800Kbps.
- The color of the light is highly consistent, cost-effective.
- With reverse power connection, it will not be damaged.
- All external electronic components including capacitors are not required.

Applications

- Consumer Electronics, LED lighting.
- LED decorative lighting, Indoor/outdoor LED irregular screen, game machine and amusement equipment etc.

General description

WS2812B-2020 is an intelligent control LED light source, its exterior adopts the latest MOLDING packaging technology, the control circuit and RGB chips are integrated in a package of **2020** component. Its internal includes intelligent digital port data latch and signal reshaping amplification drive circuit. Also include a precision internal oscillator and a voltage programmable constant current control part, effectively ensuring the pixel point light color height consistent.

The data transfer protocol use single NZR communication mode. After the pixel power-on reset, the DIN port receive data from controller, the first pixel collect initial 24bit data then sent to the internal data latch, the other data which reshaping by the internal signal reshaping amplification circuit sent to the next cascade pixel through the DO port. After transmission for each pixel, the signal to reduce 24bit. pixel adopt auto reshaping transmit technology, making the pixel cascade number is not limited the signal transmission, only depend on the speed of signal transmission.

RESET time **>280μs**, it won't cause wrong reset while interruption, it supports the lower frequency and inexpensive MCU.

Refresh Frequency updates to **2KHz**, Low Frame Frequency and No Flicker appear in HD Video Camera, it improve excellent display effect.

LED with low driving voltage, environmental protection and energy saving, high brightness, large scattering angle, good consistency, low power, long life and other advantages. The control chip integrated in LED above becoming more simple circuit, small volume, convenient installation.

Mechanical Dimensions

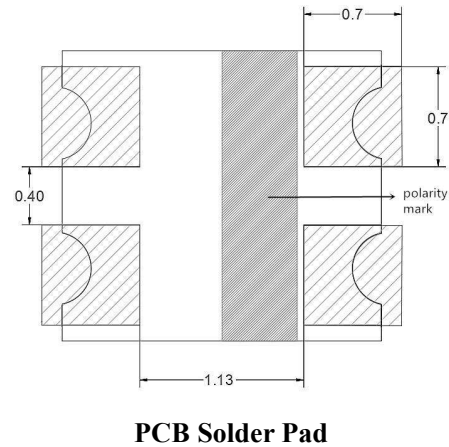
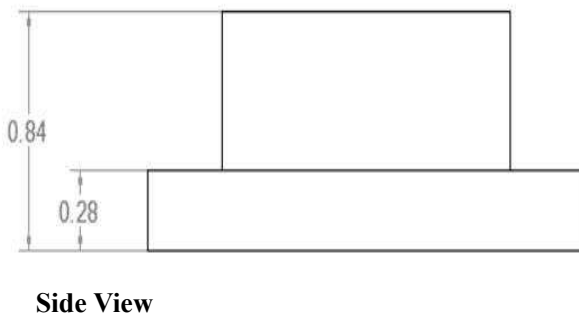
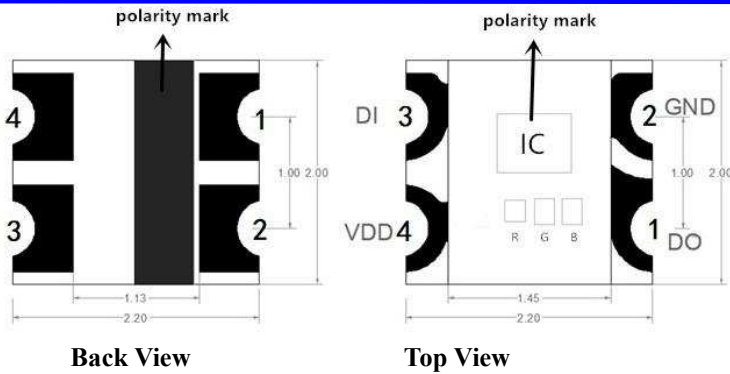

PIN Configuration

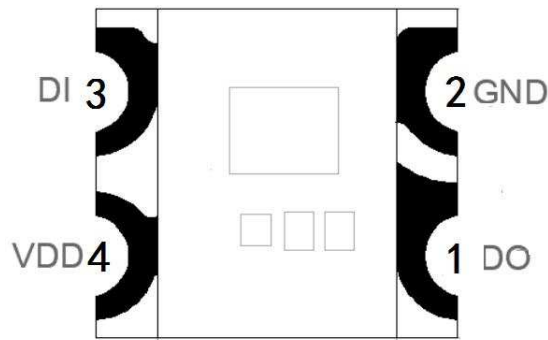

PIN Function

NO.	Symbol	PIN	Function description
1	DO	DATA OUT	Control data signal output
2	GND	GROUND	Ground, data & power grounding
3	DI	DATA IN	Control data signal input
4	VDD	POWER SUPPLY	Power supply

Absolute Maximum Ratings

Parameter	Symbol	Ratings	Unit
Power supply voltage	V _{DD}	+3.7~+5.3	V
Logical Input Voltage	V _I	V _{DD} -0.3V~V _{DD} +0.7	V
Operation junction temperature	T _{opt}	-25~+85	°C
Storage temperature range	T _{stg}	-40~+105	°C

Electrical Characteristics (T_A=25°C, V_{DD}=5V, V_{SS}=0V, unless otherwise specified)

Parameter	Symbol	Min	Typ	Max	Unit	Conditions
Input current	I _I	—	—	±1	μA	V _I =V _{DD} /V _{SS}
High Voltage Input	V _{IH}	2.7V	—	V_{DD}+0.7V	V	D _{IN} , SET
Low Voltage Input	V _{IL}	-0.3V	—	0.7V	V	D _{IN} , SET

Switching Characteristics (T_A=25°C, V_{DD}=5V, V_{SS}=0V, unless otherwise specified)

Parameter	Symbol	Min	Typ	Max	Unit	Condition
Transmission delay time	t _{PLZ}	—	—	300	ns	CL=15pF, DIN→DOUT, RL=10KΩ
Fall time	t _{THZ}	—	—	120	μs	CL=300pF, OUTR/OUTG/OUTB
Input capacity	C _I	—	—	15	pF	—

LED Characteristics

Parameter	Symbol	Color	Quiescent Current:< 0.6mA				Test Condition (Working current)
			Min.	Typ.	Max.	Unit	
Luminous intensity	IV	RED	150	200	250	mcd	12mA
		GREEN	500	600	700		
		BLUE	100	160	200		
Wavelength	λd	RED	620	622.6	630	nm	12mA
		GREEN	515	515.6	525		
		BLUE	465	470.4	475		

Data Transfer Time

T0H	0 code, high voltage time	220ns~380ns
T1H	1 code, high voltage time	580ns~1μs
T0L	0 code, low voltage time	580ns~1μs
T1L	1 code, low voltage time	580ns~1μs
RES	Frame unit, low voltage time	>280μs

Sequence Chart

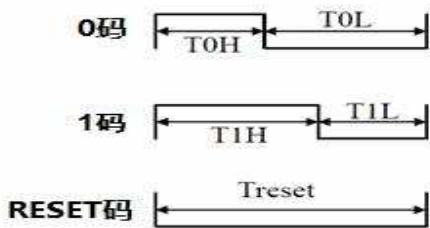

Cascade Method

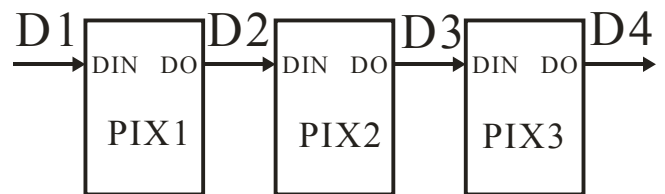

Data Transmission Method

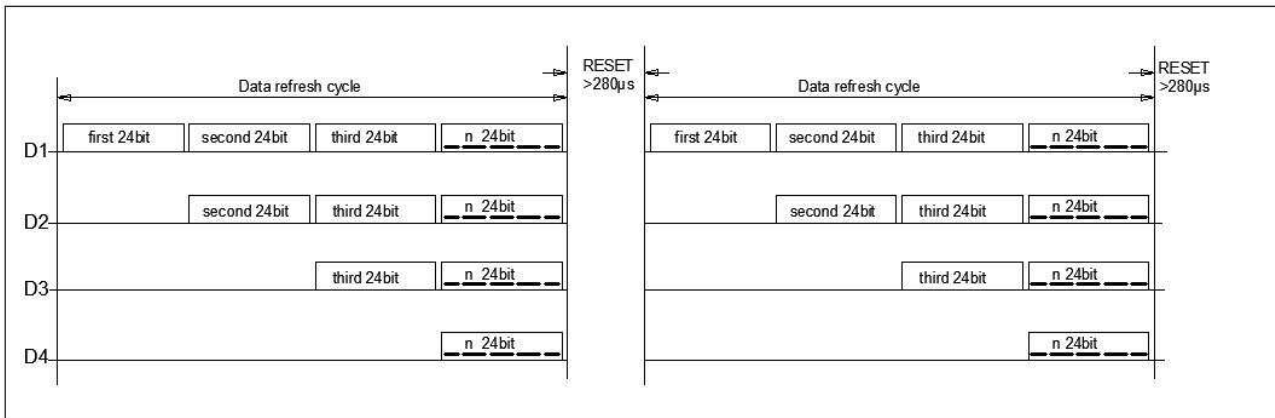

Note: The data of D1 is send by MCU, and D2, D3, D4 through pixel internal reshaping amplification to transmit.

Composition of 24bit Data

G7	G6	G5	G4	G3	G2	G1	G0	R7	R6	R5	R4	R3	R2	R1	R0	B7	B6	B5	B4	B3	B2	B1	B0
----	----	----	----	----	----	----	----	----	----	----	----	----	----	----	----	----	----	----	----	----	----	----	----

Note: Data transmit in order of GRB, high bit data at first.

Typical Application Circuit:The peripheral circuit don't need to add filter capacitor.

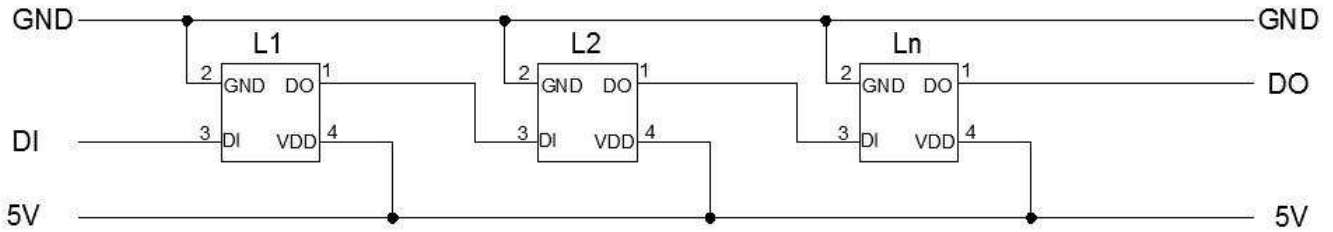

Tape Size (Unit: mm)

Inspector:

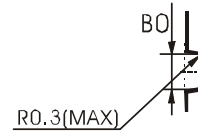
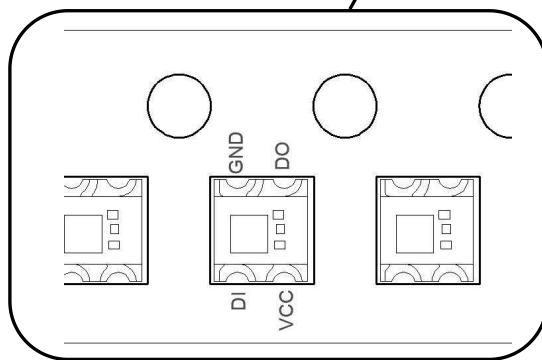
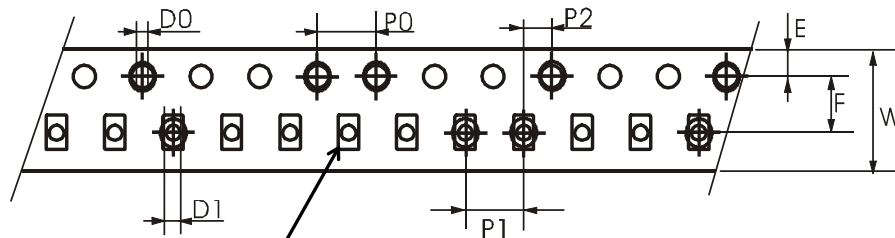

LED Taping Position

UNIT: mm

CARRIER TAPES TEST REPORTS

SYMBOL	A0	B0	K0	P0	P1	P2	T	E	F	D0	D1	W
SPEC	2.20	2.40	1.01	4.00	4.00	2.00	0.18	1.75	3.50	1.50	1.00	8.00

Reel Packing Specifications (Unit: mm)

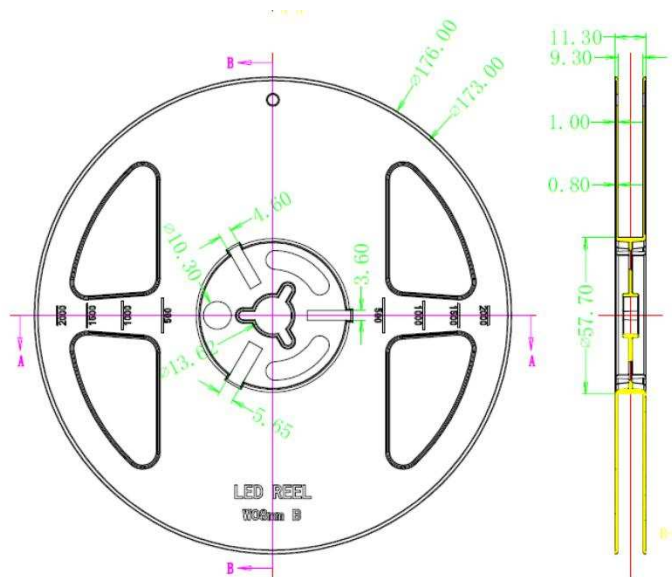

Moistureproof bag packing

SPQ: 4500PCS /Reel

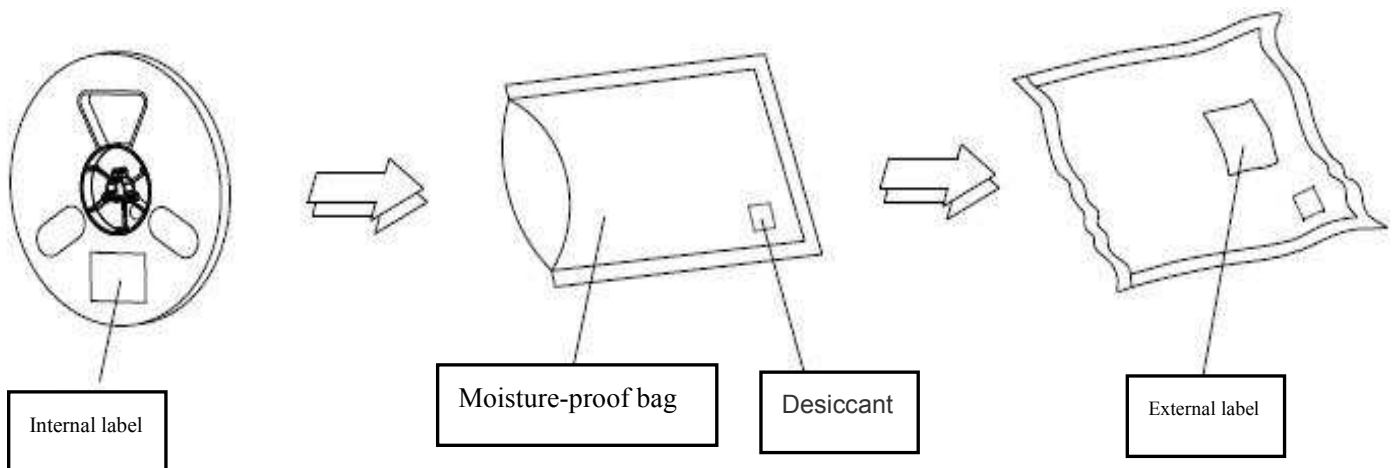

Top SMD LED Using Instructions

1. Summary

To make the best use of WORLDSEMI's LED, please refer to the below precautions, they are of same usage method as other electronic components.

2. Cautions

2.1. Dust & Cleaning

The surface of the LED is encapsulated with modified epoxy resin because it plays a very good role in protecting the optical performance and aging resistance. The modified epoxy resin is easy to stick with dust and must be kept clean. When there's a certain amount of dust on the surface of the LED, it won't affect brightness, but dust proof should be taken care of. Promoting the use of unsealed package in preference to others and the assembled LEDs should be placed in a clean container.

Avoid using the organic solvents to clean the dust on the LED surface and it's necessary to confirm whether the cleaning fluid will dissolve the LED.

Do not clean the LEDs by the ultrasonic. Some parameters affecting the LED performance must be evaluated if have no alternative but to the ultrasonic cleaning method, such as ultrasonic power, baking time and assembly conditions, etc.

2.2. Moisture-proof packaging

TOP SMD LEDs are moisture sensitive components. LEDs are packaged in aluminum foil bag to prevent the from absorbing moisture during transport and storage. A desiccant is placed in the bags to absorb moisture. If the LED absorbs moisture, then it evaporates and expands when in reflow process, which may break the colloid from the bracket and damage the optical performance of LED. For this reason, moisture-proof packaging is to prevent the from absorbing moisture during transport and storage. The moisture resistance rating of WORLDSEMI's LED is: **LEVEL 5a**.

Table I - IPC/JEDEC J-STD-020 Moisture/Reflow Sensitivity Classification

MSL Level	Workshop Life	
	Time	Conditions
LEVEL1	Unlimited	≤30°C/85%RH
LEVEL2	1 Year	≤30°C/60%RH
LEVEL2a	4 Weeks	≤30°C/60%RH
LEVEL3	168 Hours	≤30°C/60%RH
LEVEL4	72 Hours	≤30°C/60%RH
LEVEL5	48 Hours	≤30°C/60%RH
LEVEL5a	24 Hours	≤30°C/60%RH
LEVEL6	Take-out and Use immediately	≤30°C/60%RH

2.3. SMT patch description

1. Please use it under the condition of $T < 30^{\circ}\text{C}$ and $\text{RH} < 60\%$;
2. The product opening period to the reflow soldering completion time period is controlled within 24H;
3. If time-out occurs, it is necessary to dehumidify and bake the LED.

2.4 Demand for dehumidification: $75^{\circ}\text{C} / > 24\text{H}$

3. SMT Reflow

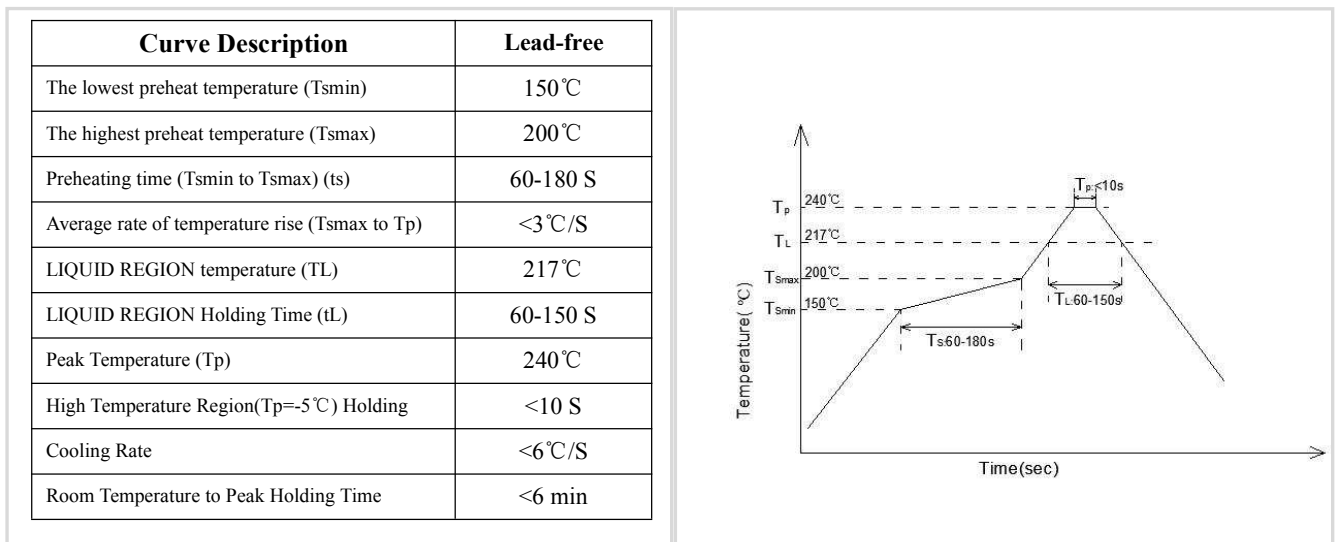

Refer to the parameters listed below, the experimental results prove that the TOP SMD LED meets the JEDEC J-STD-020C standards. As a general guideline, it is recommended to follow the SMT reflow temperature curve recommended by the solder paste manufacturer.



Remarks: 1. These general guidelines may not apply to all PCB designs and reflow soldering configurations.

2. All temperatures referred are measured on the surface of the package body.

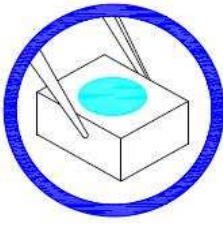
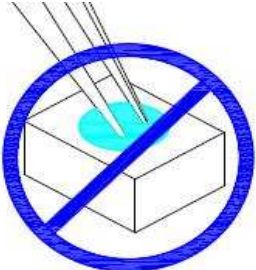
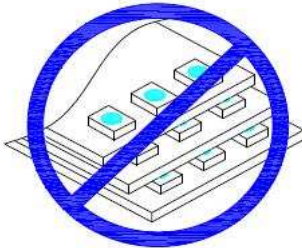
4. Assembly Precautions

1. Clip the LED from its side.	2. Neither directly touch the gel surface with the hand or sharp instrument, it may damage its internal circuit.
	
3. Not to be double stacked, it may damage its internal circuit.	4. Can not be stored in or applied in the acidic sites of PH<7.
	

Modify Record

Version №	Status Bar	Modify Content Summary	Date	Reviser	Approved
V1.0	N	New-Official release	20180808	Shen JinGuo	Yin HuaPing
V1.1	M	Maximum rating, brightness value	20181004	Shen JinGuo	Yin HuaPing
V1.2	M	Electrical parameters, cautions section	20181220	Shen JinGuo	Yin HuaPing
V1.3	A	The reverse connection of the power supply will not be damaged; there is no need for any electronic components including capacitors on the periphery.	20190125	Shen JinGuo	Yin HuaPing

Remarks: Initial version: V1.0; Version number plus "0.1" after each revision;

Status bar: N--New, A--Add, M--Modify, D--Delete.