



**HESTORE.HU**

elektronikai alkatrész áruház

**EN:** This Datasheet is presented by the manufacturer.

Please visit our website for pricing and availability at [www.hestore.hu](http://www.hestore.hu).

# User Manual for TTL-WiFi Module DT-06

**TTL-WiFi  
Manual**

V1.0

Mar., 31 2017

No.: DBH010CN

## User Manual for TTL-WiFi Transparent Transmission



## Achieve Update

Date	Version	Update
Mar, 31 2017	V1.0	First

Doctors of Intelligence & Technology Co., Ltd

**Catalog**

User Manual for TTL-WiFi Transparent Transmission.....1

1. Introduction.....4

2. Interface definition.....5

3. Usage of Web configuration .....7

**3.1 STATUS sub-configuration**.....9

**3.2 MODULE configuration page**.....10

        ■ Serial (serial configuration) .....10

        ■ WiFi (WiFi configuration).....12

        ■ Networks configuration .....15

**3.3 MORE configure**.....16

        ■ Restart.....16

        ■ Restore the factory setting .....16

        ■ Version.....17

4. Built-in AT command set .....17

5. A classical configuration example .....20

    5.1 Transparent transmission example in local network .....20

    5.2 Cloud transmission based on Doit Cloud .....22

6. Minimum system for the module .....27

7. Shape and Size .....27

8. Recommended Installation .....28

Appendix.1 Parameters of TTL-WiFi Module .....31

Appendix. 2.....31

Doctors of Intelligence & Technology Co., LTD

## 1. Introduction

TTL-WiFi is designed and developed based on ESP-M2 WiFi module from our company Shenzhen Doctors of Intelligence & Technology Co., Ltd., which is extracted the TTL, EN, STATE and other pins. **Importantly, the TTL-WiFi is already built-in the serial transparent transmission firmware** programmed by our company (SZdoit), which can realize the transparent transmit the data to the cloud on the real-time, together with low-power control, status indicator. This board can replace the old wiring serial WiFi device to realize the data collection and control. It has the following features.

- Fully compatible with the original electrical interface and physical interface for the serial transparent Bluetooth;
- Built-in the industrial transparent transmission firmware V3.0 with stability and reliability by using the Web Configuration;
- Built-in the high performance WiFi module ESP-M2 with size: 34mm\*17mm\*4mm;
- Working voltage: 4.5V~6.0V, TTL working voltage: 3.3V (compatible with 5.0V);
- Provided pins: STATE, TXD, RXD,EN;
- Average current: 80mA; when data sent, it is 170mA; but it is 20  $\mu$  A at deep sleep mode;
- Support serial AT command;
- Support re-programmable, OTA firmware update;
- Seamless transparent transmission between serial and WiFi;
- Built-in HTTP Web Server, support configure parameters by web page;
- Support re-connect automatically at WiFi STA mode and TCP Client;
- Support set baud rate, data bit, parity check, stop bits, and/or subcontracting time;
- Support baud rate (bps): 300/600/1200/2400/4800/9600/19200/38400/57600/74800/115200/  
230400/460800/921600/1843200/3686400;
- Support AP enable, self-defined SSID/password, self-defined IP and network duration;
- Automatically scan the peripheral WiFi hotspot, support STA enable, DHCP, self-defined IP;
- Support TCP Server, TCP Client, UDP Server, UDP Client and UDP local broadcast;
- Support DNS resolution automatically for the remote sever address;
- Support checking the status by AT command;
- Provide IO4 to show the WiFi status;
- Working temperature: -40°C-125°C;
- Applications: smart home, wireless data connection and transparent transmission, smart car control, wireless serial printer, LED light industrial control etc.

The Structure of TTL-WiFi can be shown as follows.

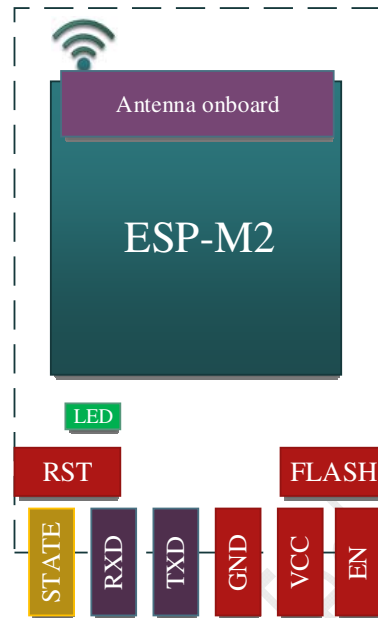

Fig. 1.1 Structure for TTL-WiFi module

***Give up the complex AT command, Simply configure parameters by Web page to transparently transmit data.***

TTL-WiFi transparent transmission firmware is developed by Shenzhen Doctors of Intelligence & Technology Co., Ltd based on the ESP-M2 wireless WiFi module, which can realize the real-time transparent transmission between serial and WiFi. After our deep research, the performance of firmware can be satisfied with industrial requirements on the stability and functionality. In this time, we have already greatly optimized the receive and transmit performance. Especially, we design the reconnection mechanisms at STA and TCP Client modes to guarantee the stable connection and transmission for the data link.

## **2. Interface definition**

The interface definition of TTL-WiFi can be shown in the following.

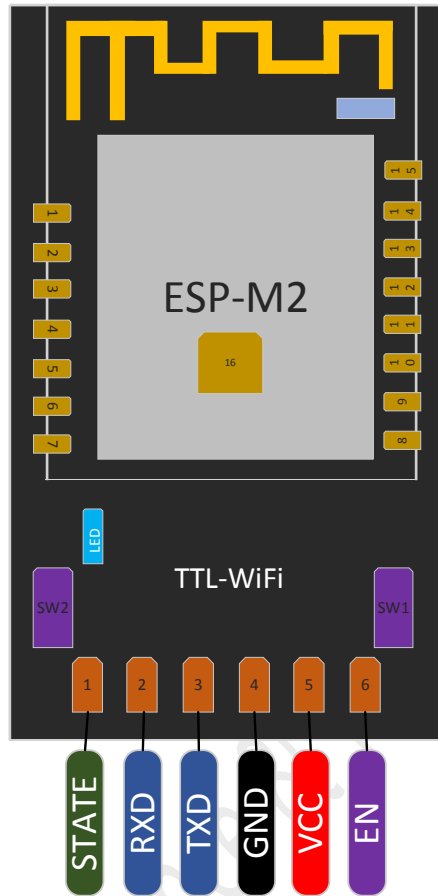

Fig. 2.1 TTL-WiFi Interface definition

Functions of button and LED

Table 2.1 Functions of button and LED

Num.	Type	Function illustration
1	LED	LED connected to VCC3.3 by a pull up resistance, and other is connected to GPIO4
2	SW1	Connected to GPIO0 to coordinate with SW2 button to download the firmware.
3	SW2	Connect to RST, to coordinate with SW1 to download the firmware

Importantly, when downloaded the firmware, please firstly press SW1 button, and then press SW2 button, and at last loose the button to finish the download. (Refer to the ESP-M2 module)

Table 2.2 LED definition

Num	LED indicator	Function
1	Always lighting	Successfully connect to the wireless router when WiFi module is at STA or STA+AP mode
2	Lighting slowly	Level for IO switches once each 1s; if works at AP mode, it shows that the WiFi module unsuccessfully connected to the wireless WiFi router;

		If at STA mode, the module is trying to connect the wireless router; If at AP+STA mode, the module is trying to connect to the wireless router.
3	Fast lighting	When press SW1/Flash button, if the serial received the data, or the network received the data from the serial, LED would light fast.
4	Extinguish	WiFi module doesn't work since the power isn't normal or isn't the transparent transmission firmware.

Definition of pins is listed as follows.

Table 2.3 Definition of pins

Num	Pin	Type	Function
1	STATE	I/O	GPIO4; built-in transparent transmission firmware, to show the net connection status: connect to wireless router at STA mode. STATE is low level.
2	RXD	I/O	GPIO3; Module is already serially connected to a 22 $\Omega$ current-limiting resistance in the inner, thus can connect 5.0V voltage; Can used as the UART Rx when built in the flash.
3	TXD	I/O	GPIO1; Module is already serially connected to a 22 $\Omega$ current-limiting resistance in the inner, thus can connect 5.0V voltage; Can used as the UART Tx when built in the flash.
4	GND	P	GND
5	VCC	P	Module power: 4.5V~6.0V, recommended voltage is 5.0V
6	EN	I	Enable, high level: enable to let chip work normally; low level, chip is closed.

### 3. Usage of Web configuration

This module is already built-in the HTTP Server. Thus, it can configure the parameters by the browsers on pc or mobile phone or other smart devices, without of need of any other tools or Apps. In the factory settings, the module works at AP mode, and the signal is "Doit\_WiFi\_XXXXXX", where, "XXXXXX" is the last 6 number of MAC address of this module. Then, one can connect this WiFi hotspot by PCs or phones, and other smart deveices (supportable Android and Ios, Windows) with no password.





Fig. 3. 2 Default WiFi hotspot

After successful connection, input the default IP address: “**192.168.4.1**”.



Fig. 3. 3 Information for hotspot

When open the configuration, there is three sub-pages, STATUS, MODULE, and MORE, as shown in the following.

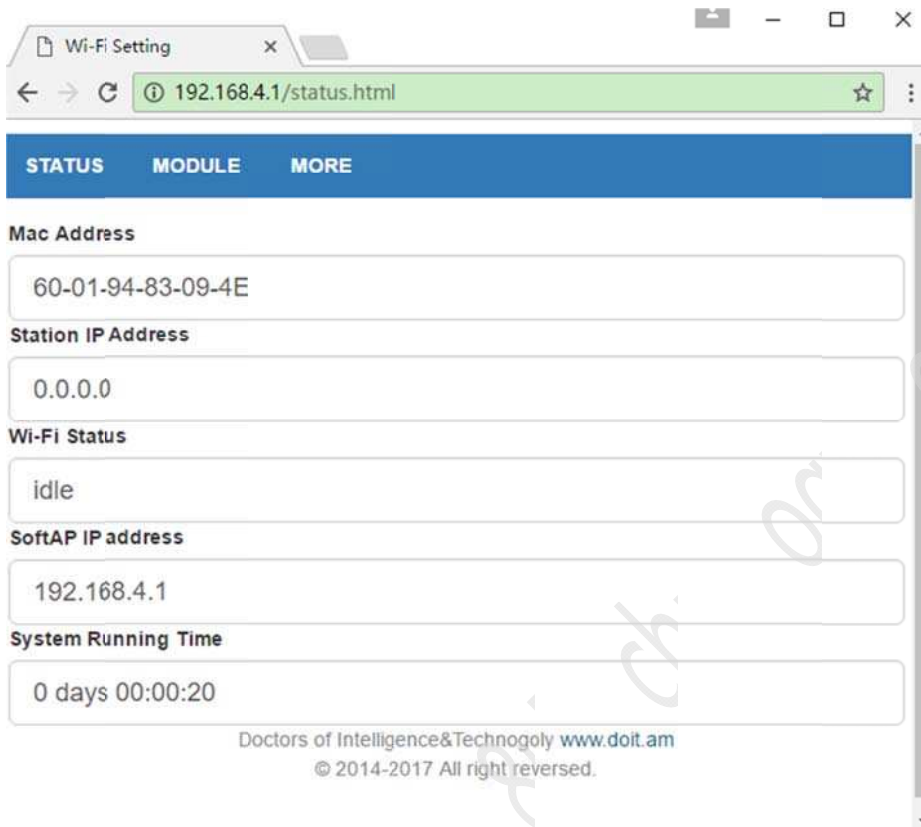

Fig. 3. 4 Configuration

### 3.1 STATUS sub-configuration

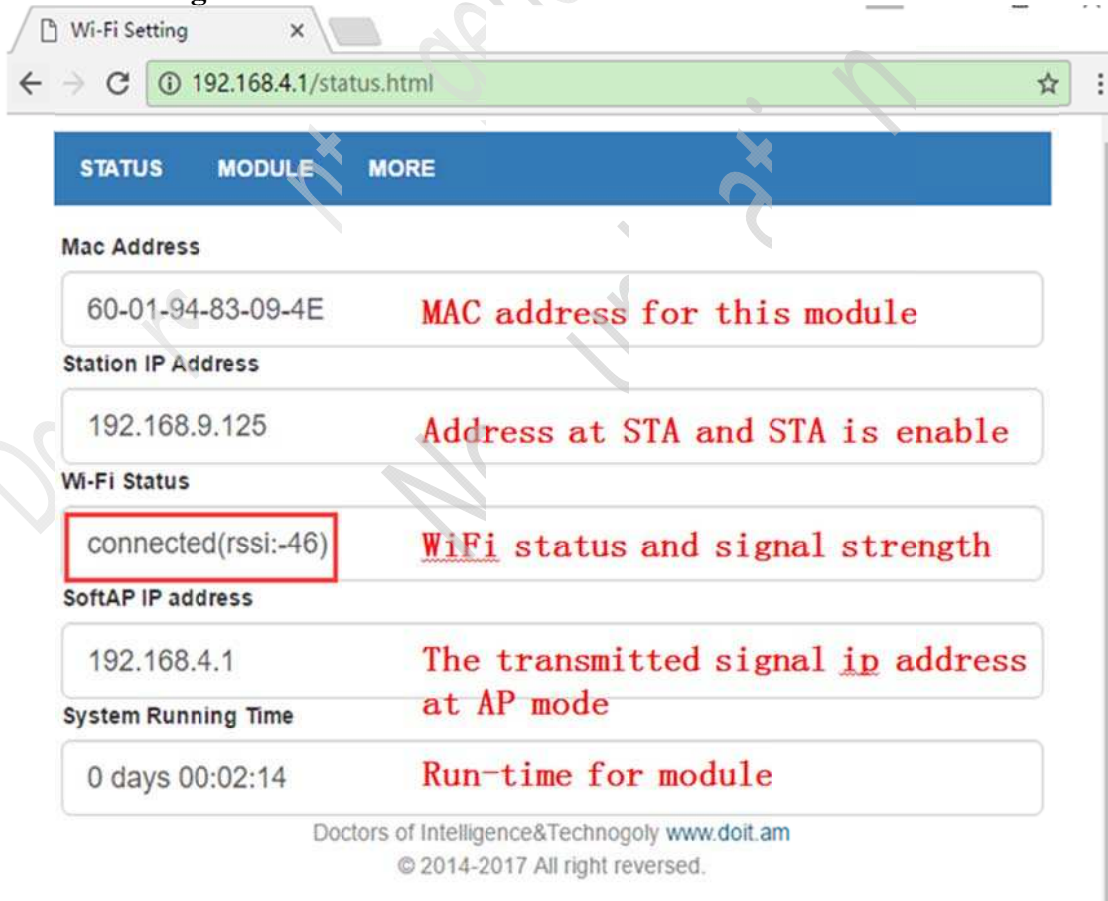

Fig. 3. 5 Successful connection at STA mode

On the STATUS page, it displays much information, e.g., MAC address, IP address at STA mode, WiFi connection status, IP address at AP mode, and the run time, where “Wi-Fi Status”: its value can be “idle”, “connecting”, “wrong password”, “no ap found”, “connect failed”, “connected (rssi:xxx)”. If STA is connected successfully, it would display the signal strength (i.e., RSSI value, it is a negative). “System Running Time”: display the run time for the device.

### 3.2 MODULE configuration page

“MODULE” page has 3 sub-menus, which can provide many configurations.

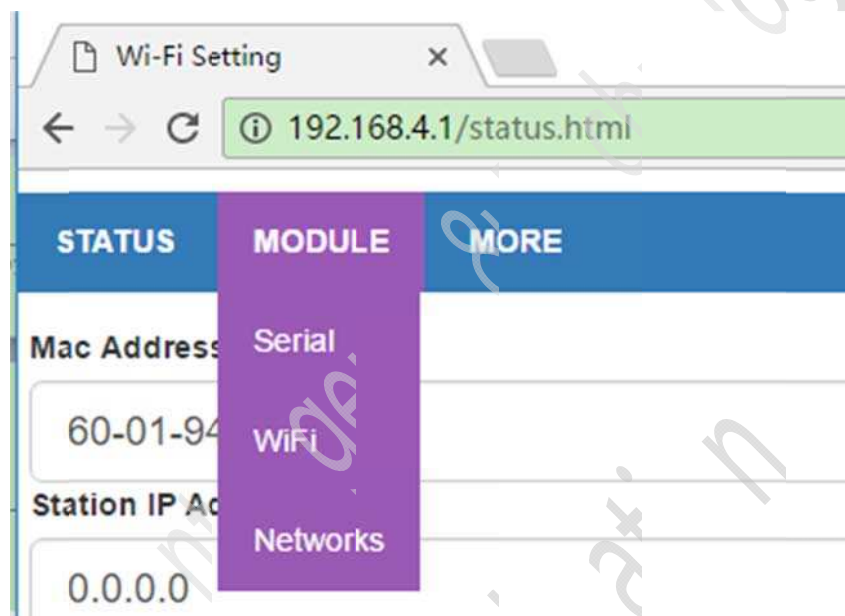

Fig. 3. 6 MODULE menu

#### ■ Serial (serial configuration)

In this page, one can set the serial baud rate, data bits, parity checking, stopbits, etc. At the same, one can set the package subextract time.

- Set serial baud

rate:300/600/1200/2400/4800/9600/19200/38400/57600/74800/115200/230400/460800/921600/  
1843200/3686400

- Data bit: 5/6/7/8
- Parity checking: NONE/ODD/EVEN
- Stopbits: 1/1.5/2

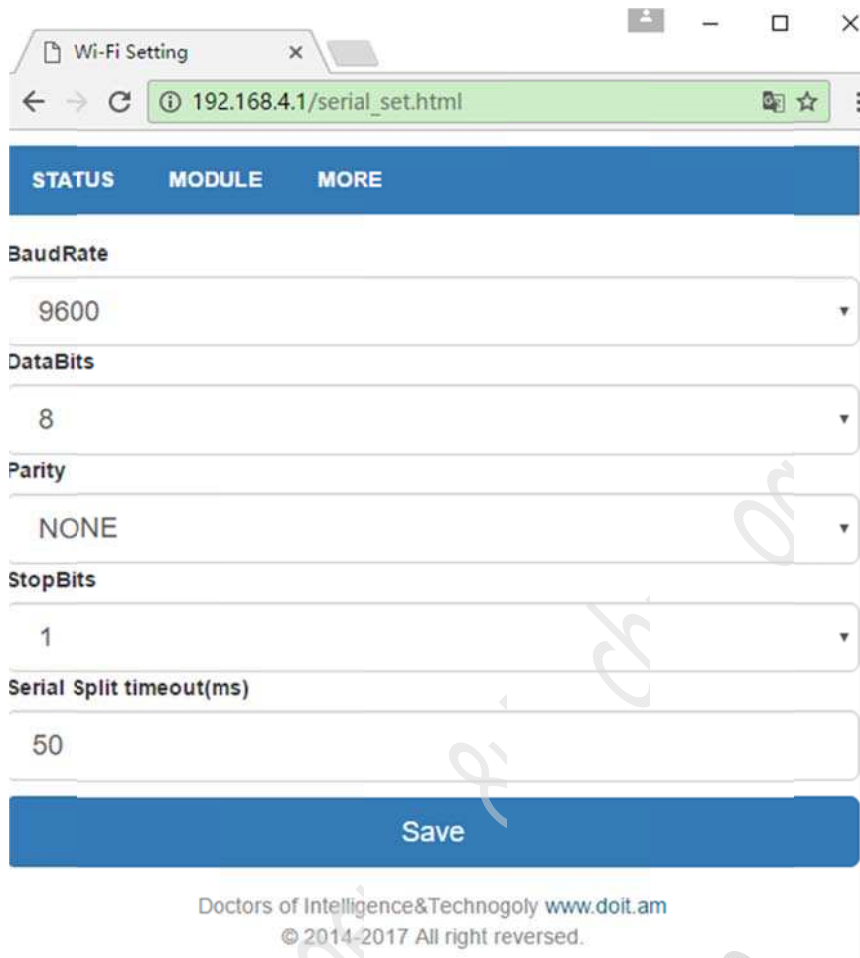

Fig. 3. 6 Serial configuration page

After setting, can use “Save ” to save the setting. If there are some errors for the parameters, it would remind you a failure. Or, it would successful.

Especially, if the setting is successful, then the parameters are enable after reboot the WiFi module.

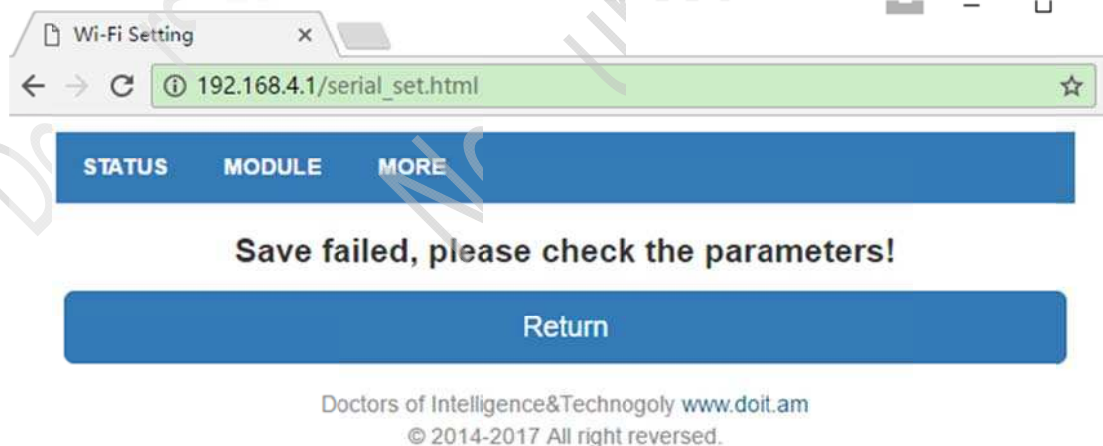

Fig. 3.7 Failure page after save

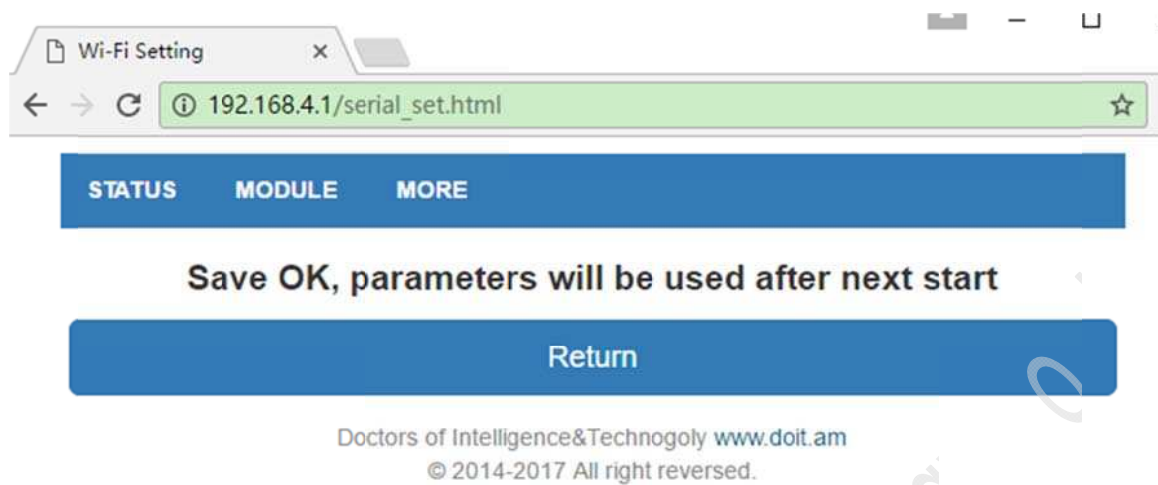

Fig. 3.8 Success page after save

In the later, the web sets are similar, this manual would be ignored.

#### ■ WiFi (WiFi configuration)

WiFi module can be set at AP, STA, and AP+STA modes.

**Note: transmit a signal, and other devices can connect it; STA: as a slaver to connect the other WiFi signal.**

AP setting:

- Can open or close AP mode;
- Self-define the name and password for the AP. If password is none, then it doesn't encrypted; or would use web encrypted to connect the WiFi signal. **Note: WiFi password needs 8~63 characters.**
- Self-define IP address, sub network mask, and gateway address for WiFi module at AP mode.

**Note: at AP mode, the IP, sub-network mask, and gateway address must be not the same network duration from those at STA mode. For example, at AP mode, if IP is 192.168.4.1, then the IP at STA cannot be 192.168.4.X.**

Wi-Fi Setting

192.168.4.1/wifi\_set.html

STATUS MODULE MORE

**Soft AP Settings** Choose for AP Mode

Enable  Disable

SSID Name

Soft AP SSID

Password

8-63 ASCII chars or spaces

SoftAP IP

ip address of this module

SoftAP netmask

netmask of this module

SoftAP gateway

gateway of this module

**Station Settings**

Enable  Disable

Fig. 3.9 WiFi Configuration-AP mode

#### STA setting

- When open the WiFi configuration page, the WiFi module would scan the WiFi hotspot listed in the table block.
- Set the SSID and Password for the wireless router.
- Whether starts DHCP, if yes, then, IP, netmask, gateway address cannot be assigned. Or, it need to be assigned.

**Note: at AP mode, the IP, sub-network mask, and gateway address must be not the same network duration from those at STA mode. For example, at AP mode, if IP is 192.168.4.1, then the IP at STA cannot be 192.168.4.X.**

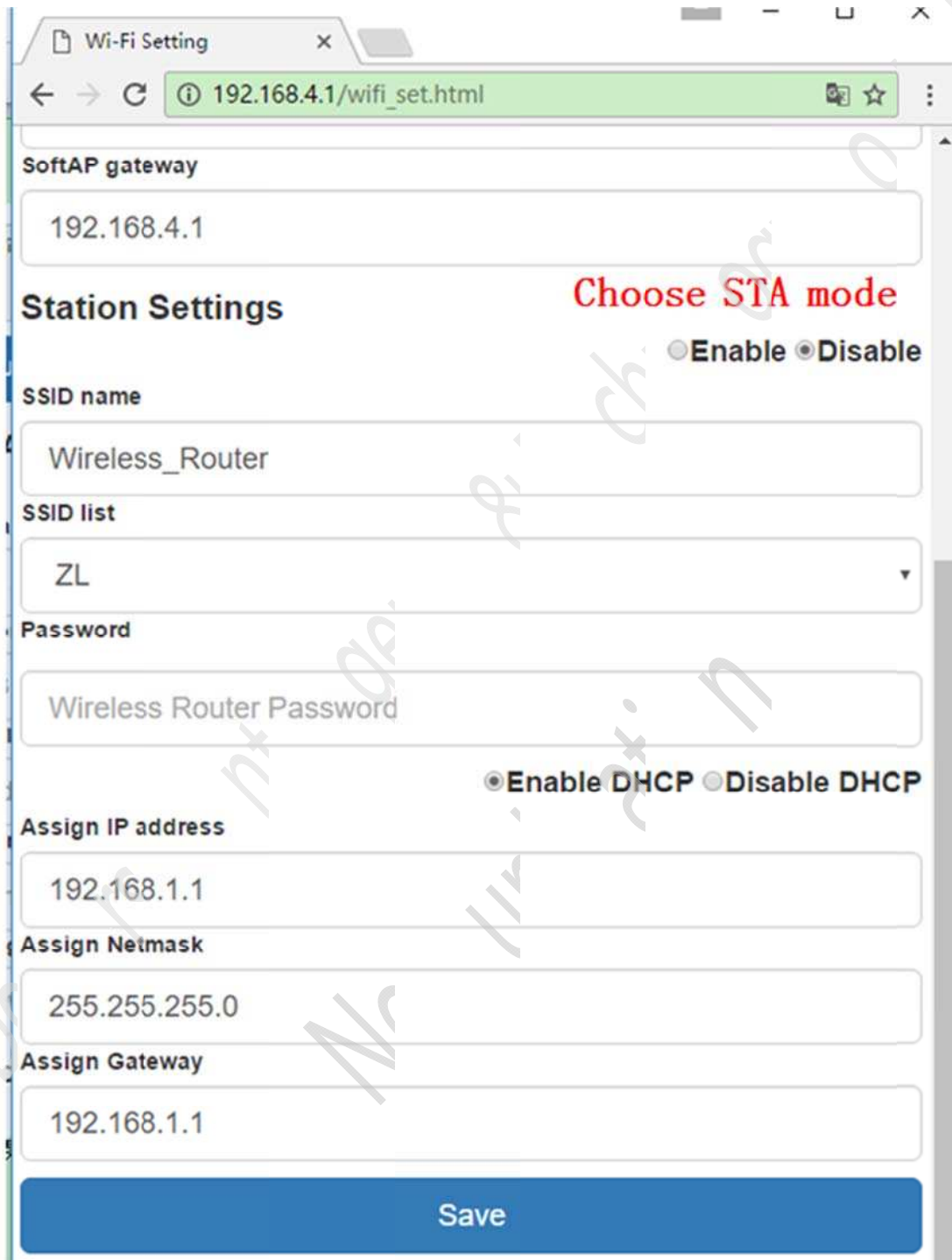

The screenshot shows a web browser window titled "Wi-Fi Setting" with the address bar displaying "192.168.4.1/wifi\_set.html". The page content includes the following fields and controls:

- SoftAP gateway:** A text input field containing "192.168.4.1".
- Station Settings:** A section header with a red text annotation "Choose STA mode" next to it.
- Enable/Disable:** Radio buttons for "Enable" and "Disable", with "Disable" selected.
- SSID name:** A text input field containing "Wireless\_Router".
- SSID list:** A dropdown menu showing "ZL".
- Password:** A text input field containing "Wireless Router Password".
- Enable DHCP/Disable DHCP:** Radio buttons for "Enable DHCP" and "Disable DHCP", with "Enable DHCP" selected.
- Assign IP address:** A text input field containing "192.168.1.1".
- Assign Netmask:** A text input field containing "255.255.255.0".
- Assign Gateway:** A text input field containing "192.168.1.1".
- Save:** A large blue button at the bottom of the form.

Fig. 3.10 WiFi configuration-STA mode

## ■ Networks configuration

In the network configuration, one can set the net work mode for this WiFi module. The optional work modes have TCP server/Client, UDP server/Client, and UDP broadcast, where

- When TCP/UDP Client is chosen, the IP address of remote server can support the dynamical domain name. At this time, our firmware can get the IP address automatically by the domain name;
- UDP mode can support the broadcast in the local networks. The writing rule is 192.168.x.255, where “x” is the obtained IP address segment at STA mode.

The screenshot shows a web browser window titled "Wi-Fi Setting" with the address bar displaying "192.168.4.1/net\_set.html". The interface has a blue header with "STATUS", "MODULE", and "MORE" tabs. Below the header, the "Networks" section contains several configuration fields with red annotations:

- Socket Type:** A dropdown menu with "TCP Server" selected. Red text above it says "Server: waiting connect" and below it says "Client: connect to the cloud".
- TCP Server Local Port:** A text input field containing "9000". Red text to its right says "Port number at Server mode".
- TCP Client:** A text input field containing "192.168.1.100". Red text to its right says "IP or domain name at client mode".
- TCP Client Port:** A text input field containing "6000". Red text to its right says "Port number at client".
- UDP Server:** A text input field containing "9000". Red text to its right says "Port number at UDP Server".
- UDP Broadcast(eg:192.168.x.255):** A text input field containing "192.168.1.255". Red text to its right says "IP address at UDP mode".
- UDP Broadcast Port:** A text input field containing "9000". Red text to its right says "Port at UDP mode".
- UDP Client:** A text input field containing "192.168.1.100". Red text to its right says "IP or domain name at UDP client mode".
- UDP Client Port:** A text input field containing "6000". Red text to its right says "Communication port number".

At the bottom of the form is a blue "Save" button.

Fig. 3.11 Network configuration



### 3.3 MORE configure

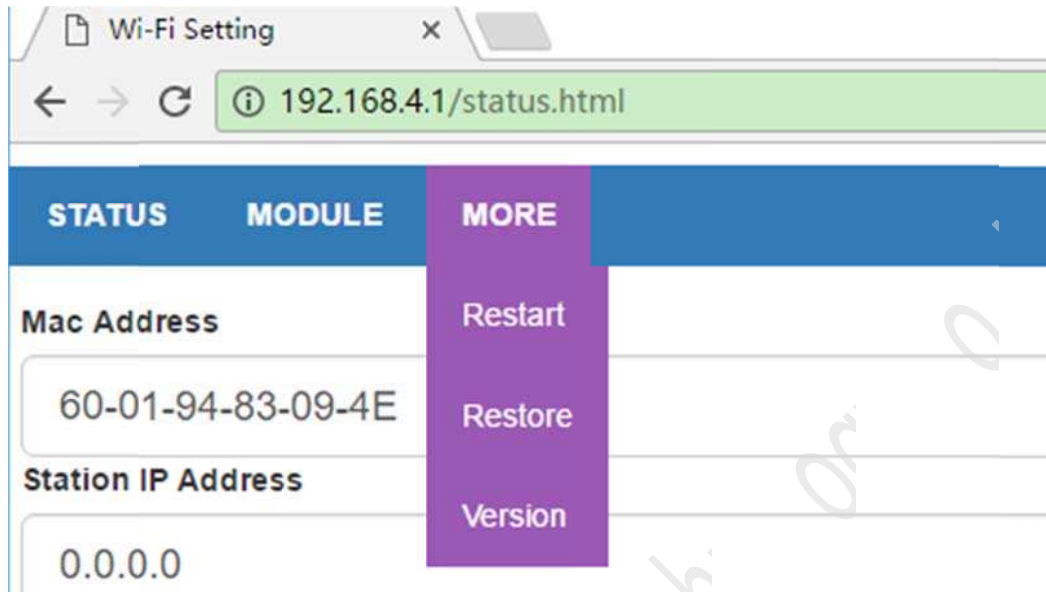

Figure 3.12 More configure

#### ■ Restart

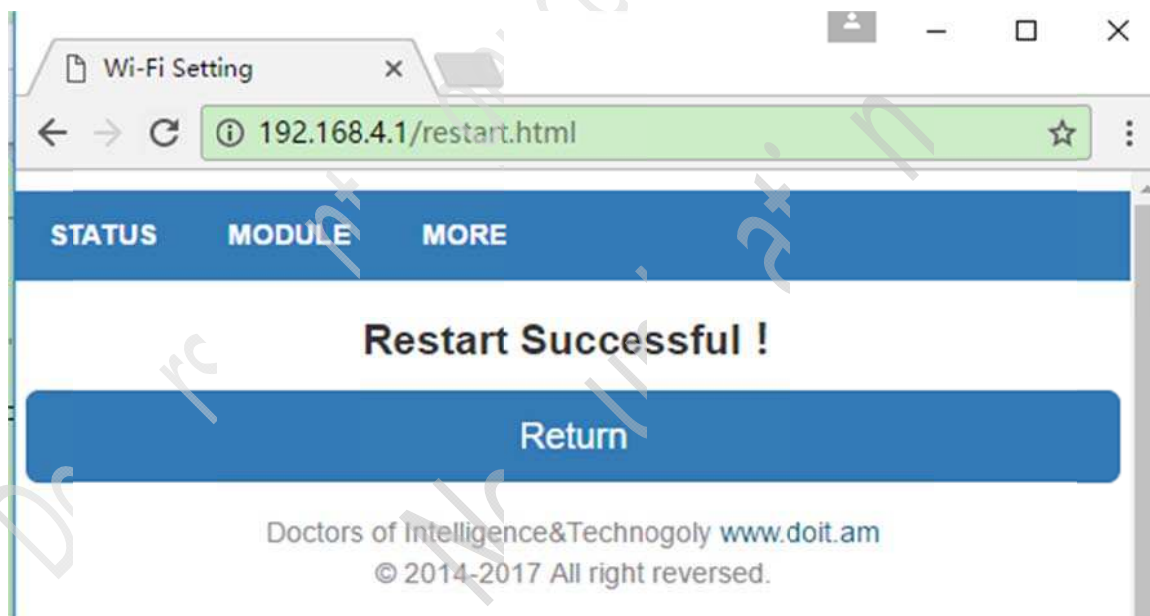

Fig. 3. 7 Re-start page

#### ■ Restore the factory setting

The factory parameters:

STA is closed, working at AP mode, IP address is 192.168.4.1;

Serial parameters is 9600, n, 8, 1, subextract time is 50ms;

Network configuration is TCP Server, monitor port is 9000.

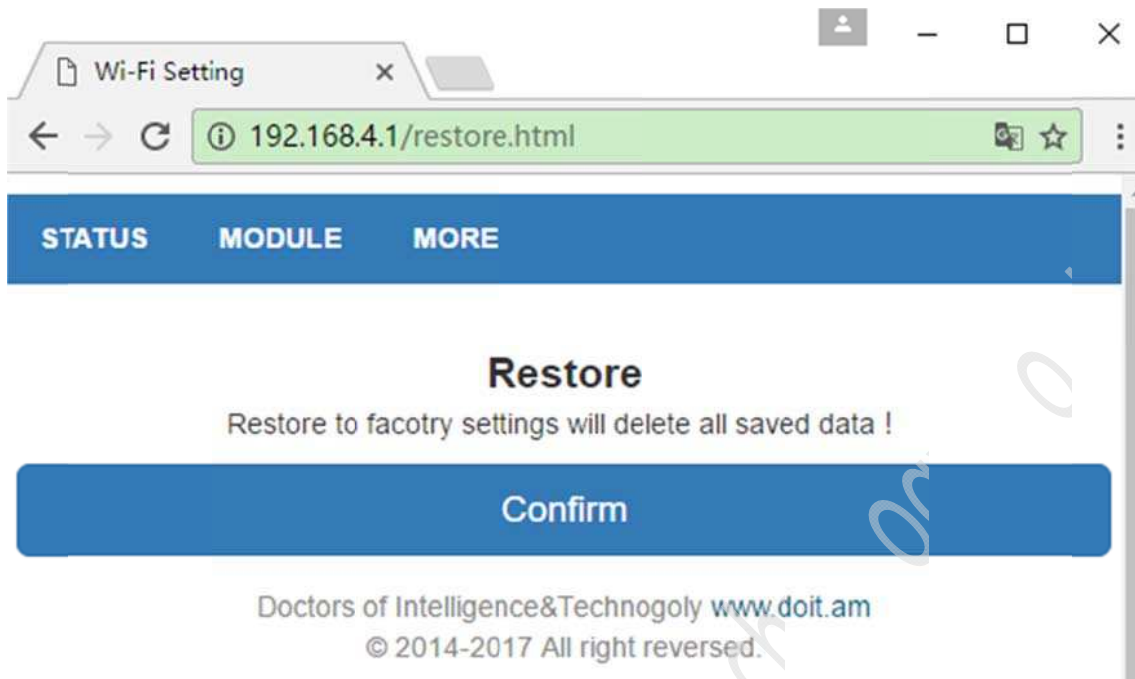

Fig. 3. 8 Restore the factory

#### ■ Version

Check the versions of software and hardware.

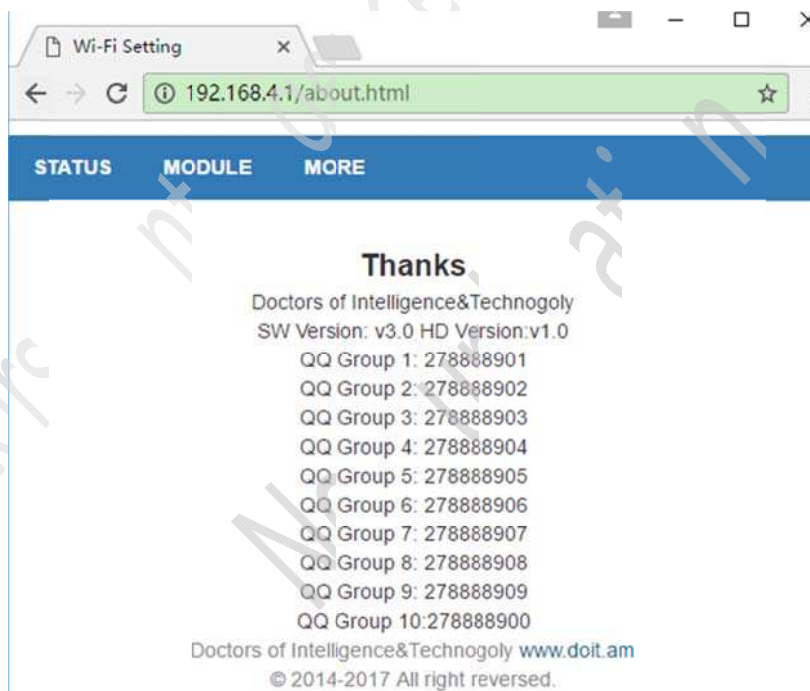

Fig. 3. 9 Check version

## 4. Built-in AT command set

Our transparent transmission firmware is already built-in the serial AT command to get the current status of WiFi module, or restore the WiFi parameters, which are listed as follows.

Table 4. 2built-in AT command set

Data direction	Command(ASCII string)	meaning
STA status check		
MCU->WiFi module	AT+STASTATUS	Check the STA status
WiFi module->MCU	STA:OK	WiFi module replies STA successful connection
WiFi module->MCU	STA:DOWN	WiFi module replies STA connection is closed
Get IP and MAC at STA mode		
MCU-> WiFi module	AT+STAINFO	Get IP and MAC from WiFi module
WiFi module->MCU	Mac IP, for example 5CCF7F116380 192.168.1. 125	Get the MAC and IP at STA mode
Check the connection status at TCP Client mode		
MCU-> WiFi module	AT+TCPCLIENT	Check the connection status at TCP Client mode, and no meaning at other modes.
WiFi module->MCU	TCP: OK	TCP client is already connected
WiFi module->MCU	TCP: OFF	TCP client is off the connection
Restart module		
MCU->WiFi module	AT+RST	Restart WiFi module
WiFi module->MCU	RST: OK	Immediately reply when received the command
Restore the factory setting		
MCU->WiFi module	AT+RESTORE	Immediately reset after WiFi restores
WiFi module->MCU	RESTORE: OK	Immediately reply when received the command

Take a example

**Step 1:** use a USB-TTL module to connect TTL-WiFi module, and then open the corresponding serial port, and press the RST button to restart the board.

**Step2:** send “AT+STASTATUS” to check the connection of STA.



Fig. 4.1 AT+STSTATUS

**Step 3:** use this command to restart the module: AT+RST



Fig. 4.2 AT+RST

## 5. A classical configuration example

In this section, we will provide two examples to show the usage of the firmware. Take the TTL-WiFi module to connect USB-TTL module as an example. USB-TTL module is connected to the USB of PC.

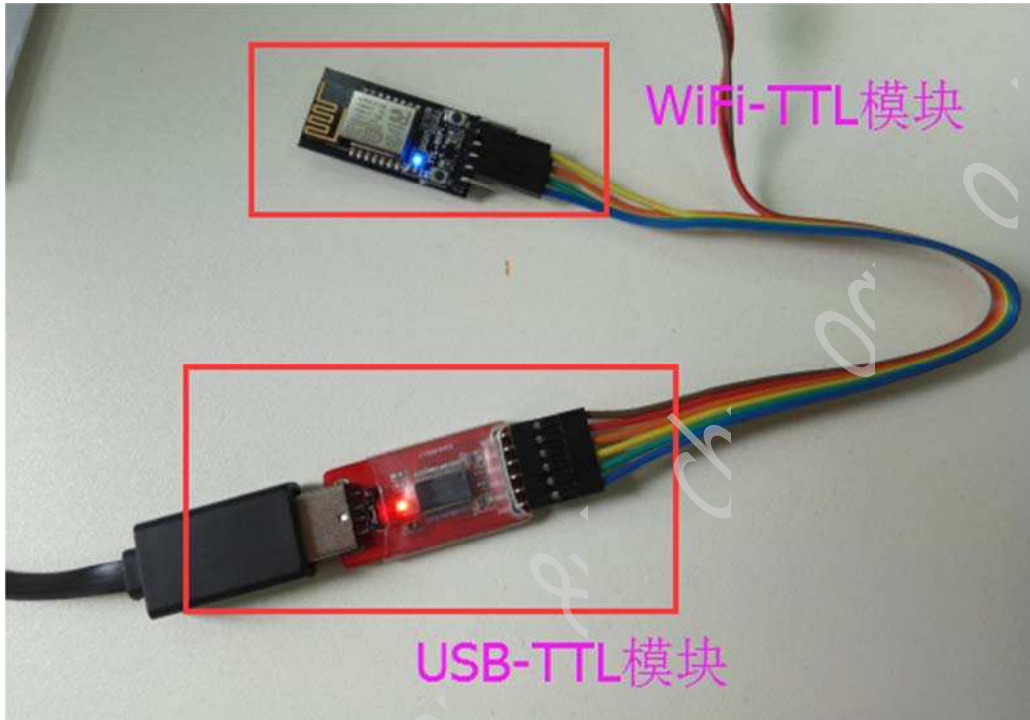

Fig. 5.1 Connection for USB-TTL module

### 5.1 Transparent transmission example in local network

In this example, we would like to realize the transparent transmission between WiFi serial port and PC. In the default case, STA is closed in the firmware, while the serial parameters is 9600,n, 8,1 at AP mode. Network configuration is TCP Server, and the monitor port is 9000.

**Step 2::** connect “Doit\_WiFi\_xxxxxx”, where “xxxxxx” is the MAC address of WiFi module, and here, the value is “83094E”.



Fig. 5.2 Connection to WiFi hotspot

**Step 2:** Use TCP Debug to create a TCP Client to connect the “9003” port of “192.168.4.1”. At the same time, open a serial debug tool, e.g., DoitSerialCOM to connect USB-TTL module, and set the serial parameters as 9600, n, 8,1. By this way, one can realize the transparent transmission from serial port to the WiFi.

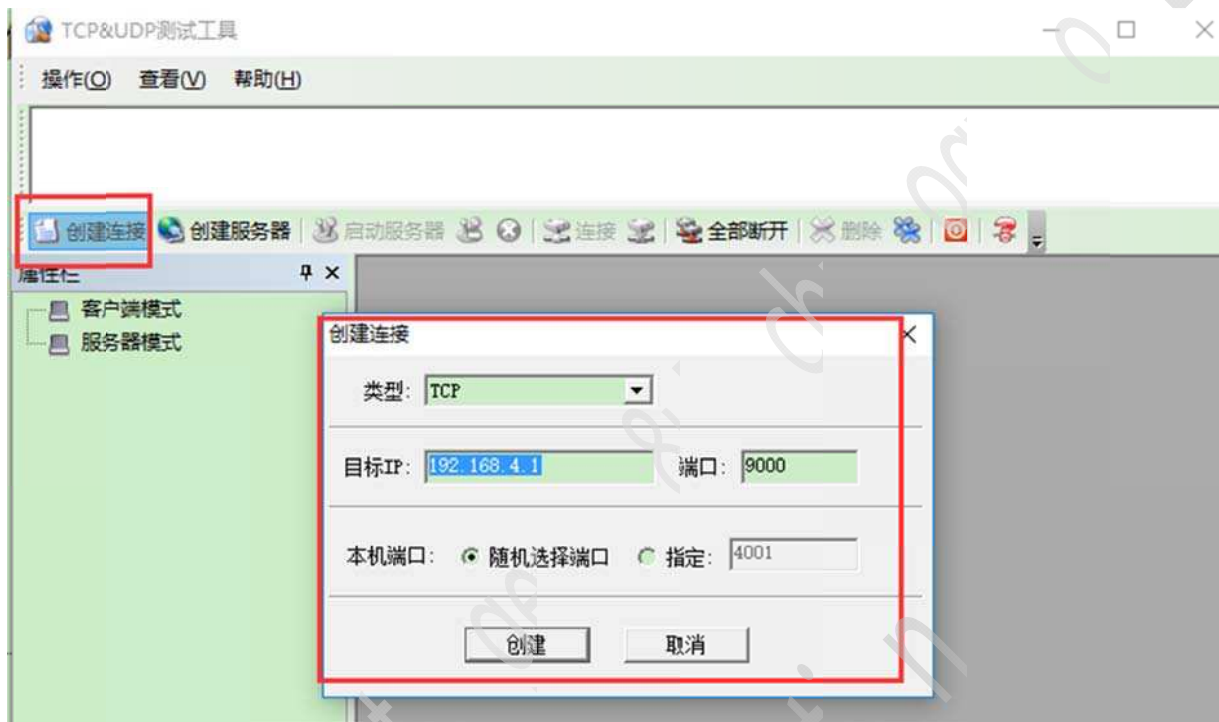

Fig. 5.3 TCP Client setting

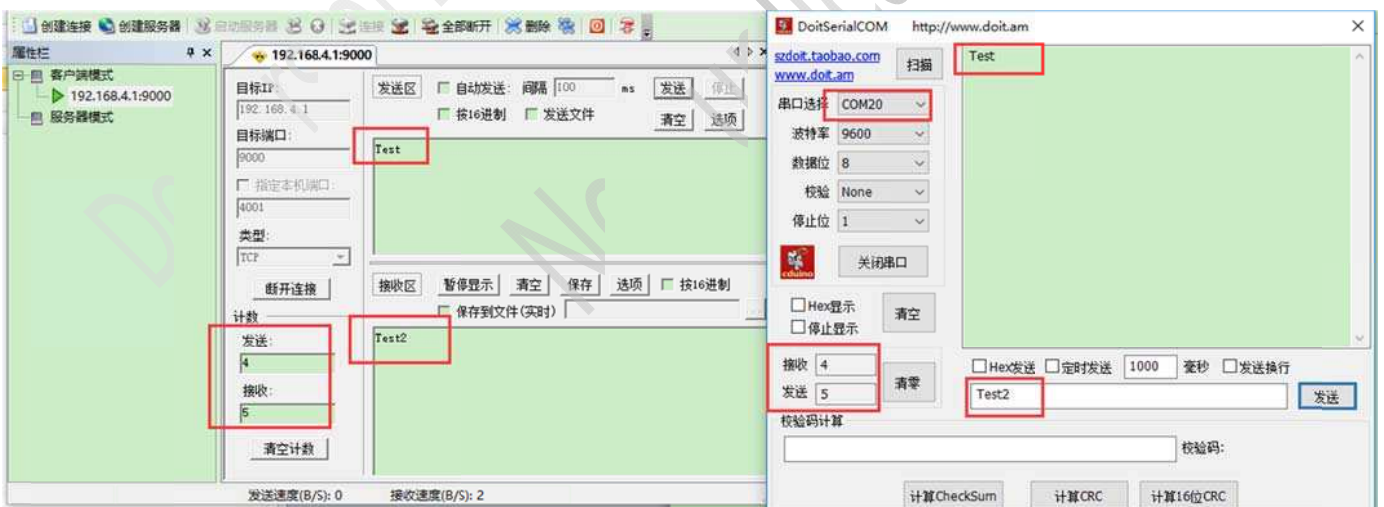

Fig. 5.4 Example for transparent transmission

## 5.2 Cloud transmission based on Doit Cloud

Based on the Doit cloud, one can realize the data remote transparent transmission between WiFi module serial port and APP.

**Step 1:** open the “tcp.doit.am” on our PC, and can get the IP and port from the Doit cloud (the usage is attached in this page for the Doit cloud). As shown in the following picture, get a temporary IP address and port, e.g., “115.29.109.104” and the port is “6524”.

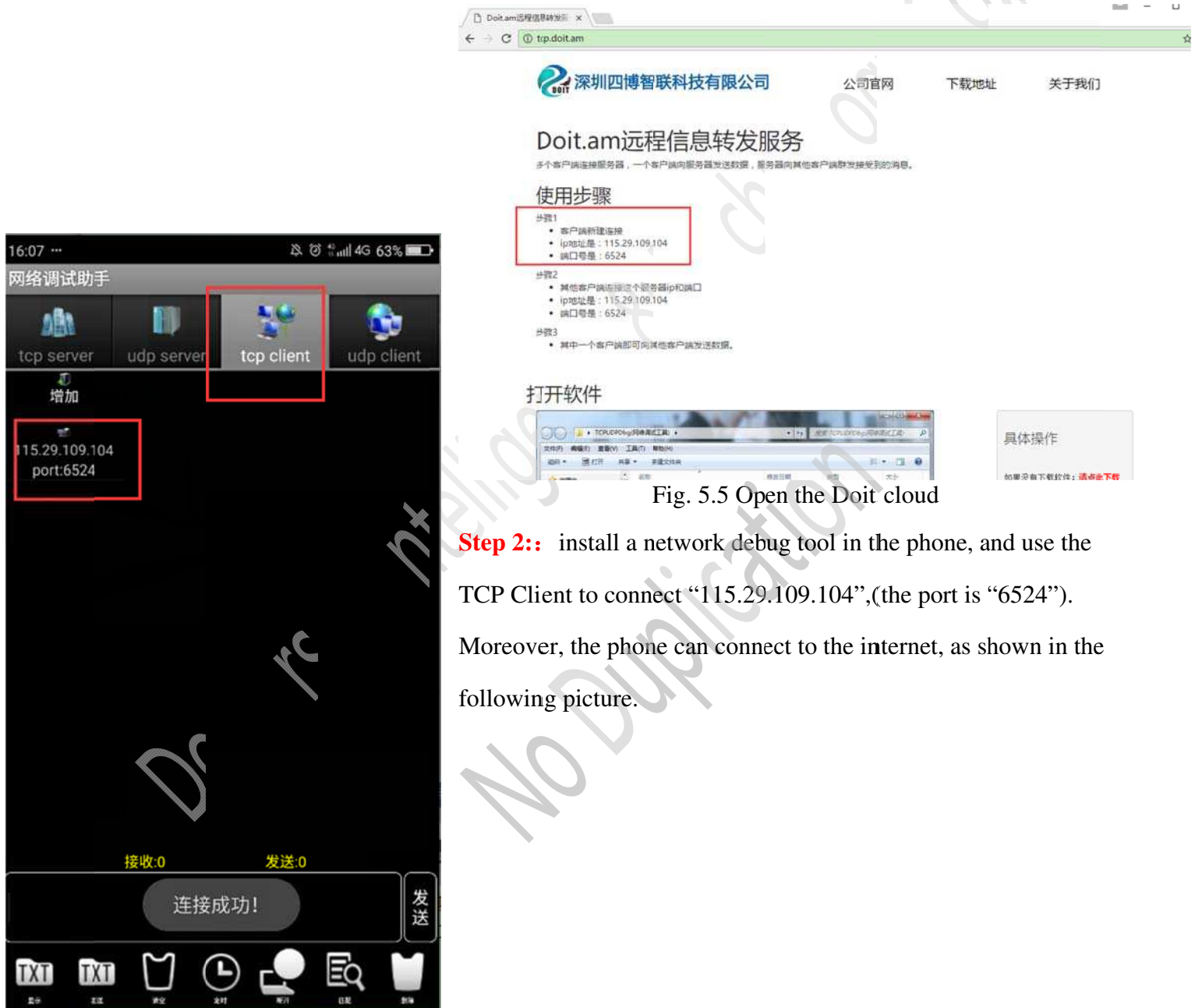

Fig. 5.5 Open the Doit cloud

**Step 2::** install a network debug tool in the phone, and use the TCP Client to connect “115.29.109.104”,(the port is “6524”). Moreover, the phone can connect to the internet, as shown in the following picture.

Fig 5.6 Network debug on the phone

**Step 3:** WiFi module connects physically to the PC by USB-TTL module, and then power.

Firstly, let phone connect the WiFi hotspot with the factory parameters, and enter into the WiFi configuration page. Set WiFi module work at STA mode, and input SSID and PASSWORD of the wireless router, and save it. In this example, STA mode is enable, SSID Name is “Doit”, and password is “doit3305”, other parameters are the default settings. (Note that, SSID and password is for your used wireless router. Doit is the router from our company)

Then, enter into the network configuration page, choose TCP Client, and the IP and port is “115.29.109.104” and “6524”.

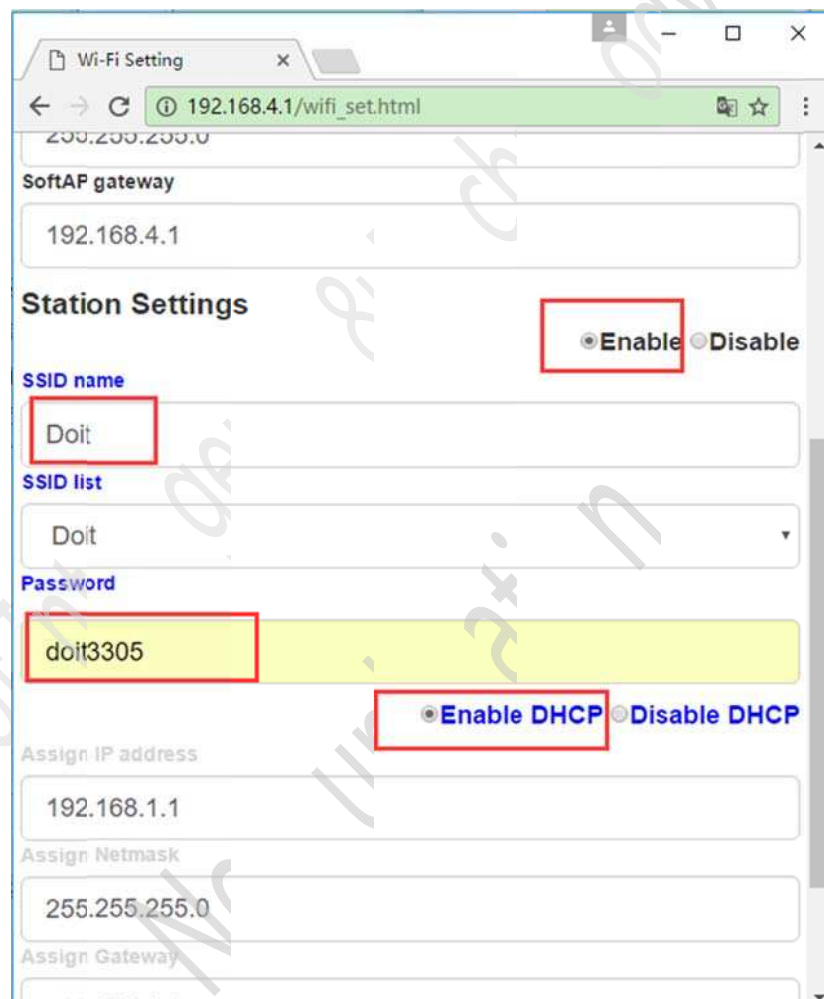

Fig. 5.7 STA mode configuration



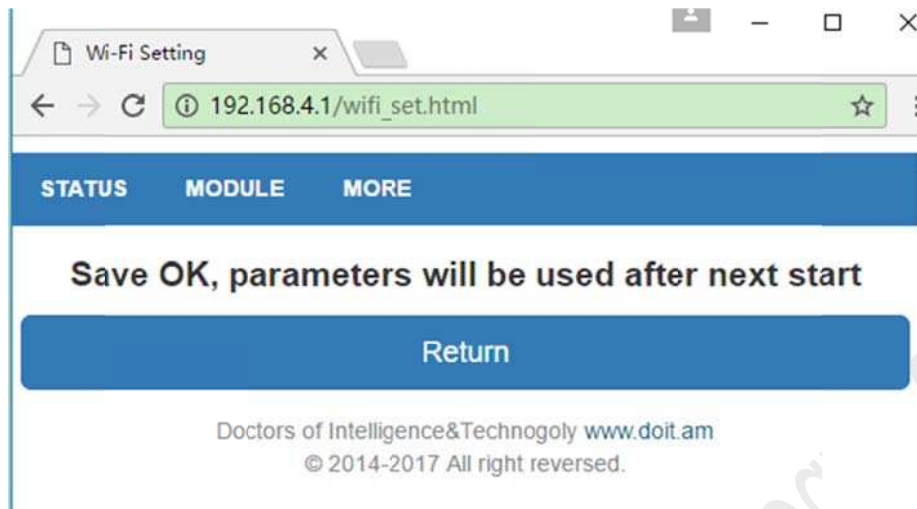

Fig. 5.8 Saving parameters at STA mode

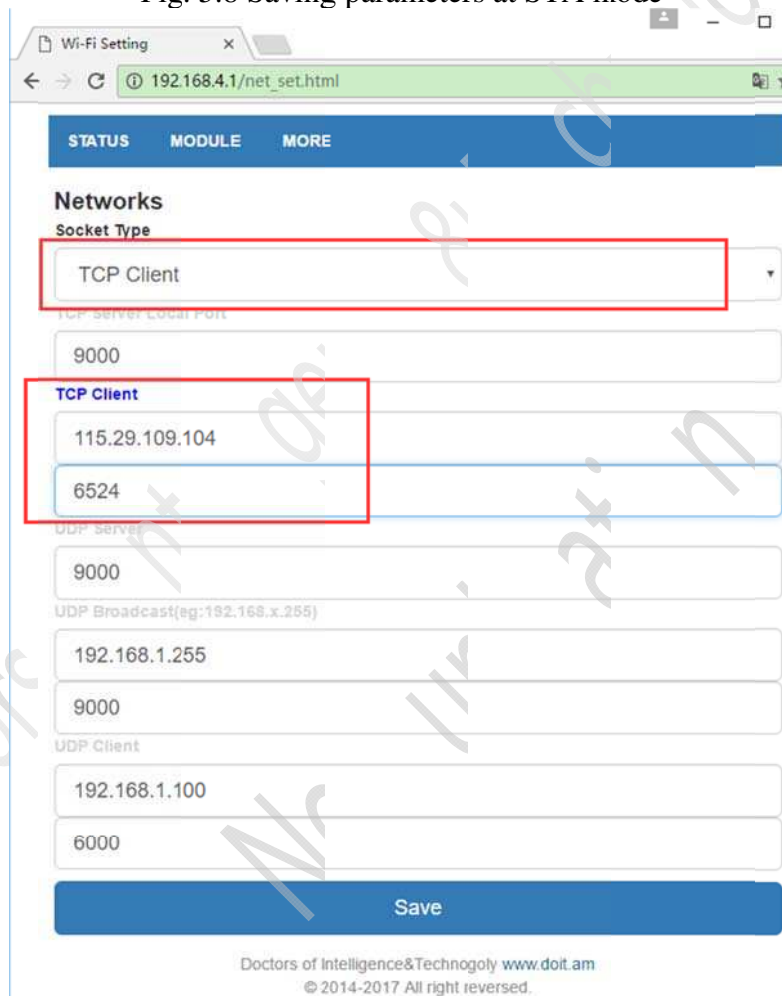

Fig. 5.9 Network configuration

**Step 4:** Restart the WiFi module to make the setting effective, and then can realize the data transparent transmission between APP and WiFi module.



Fig. 5.10 Receiving data at serial port

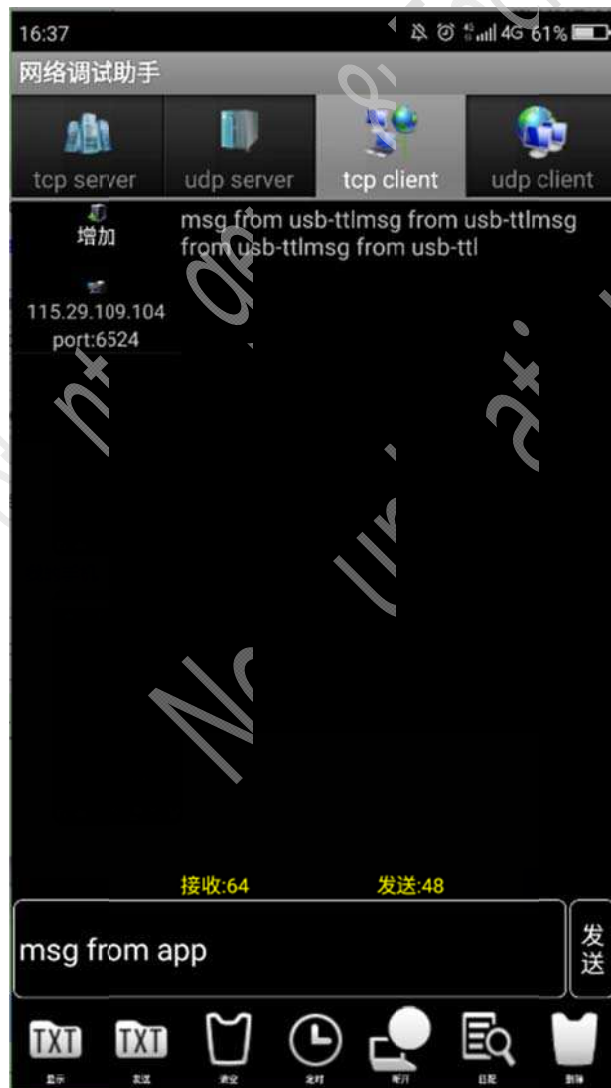

Fig. 5.11 Receiving data at APP

Doctors of Intelligence & Technology Co., Ltd  
No Duplication

## 6. Minimum system for the module

This WiFi module can work at 5.0V. Pin2 (RXD), Pin3(TXD) connect to TXD and RXD for the other MCU, Respectively.

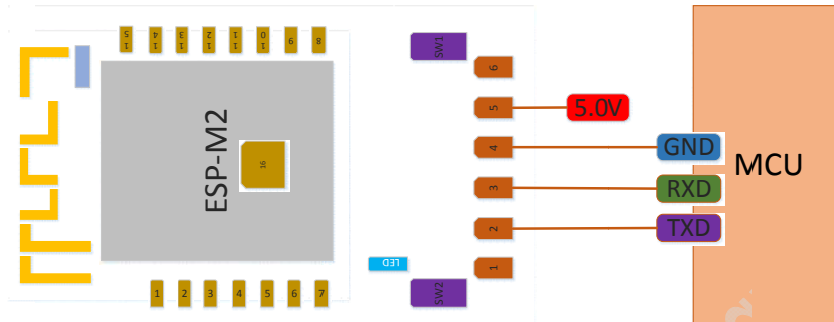

Fig. 6.1 Minimum system

Note:

- (1) The max current of IO of module is 12mA;
- (2) EN makes pin high level;
- (3) Module would enter into a update mode: GPIO0 is at low level (press SW1), and then let the module reset to power ;
- (4) RXD of the WiFi module is connected to TXD for other MCU, and similarly, TXD is connected to the RXD of other MCU.

## 7. Shape and Size

The shape and size are shown in the follows.

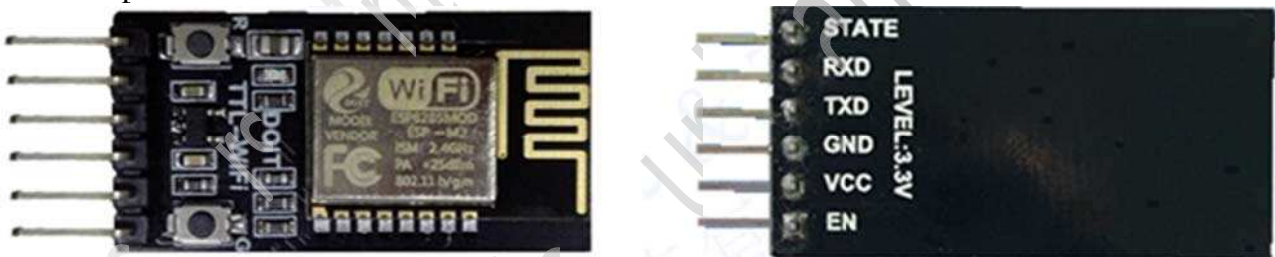

Fig. 7.1 Shape of TTL-WiFi

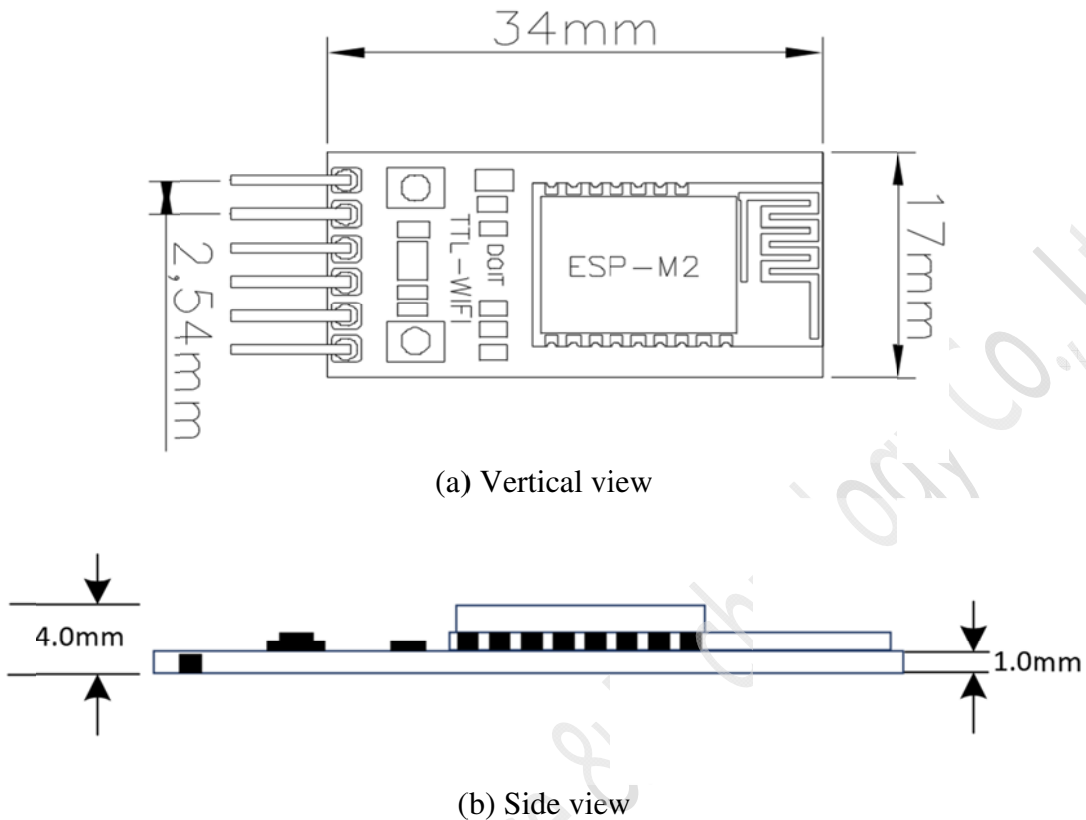

Fig. 7.2 Size of TTL-WiFi module

Table 7.1 Size of TTL-WiFi module

Length	Width	Height	Pin	Distance between Pins
34mm	17mm	4 mm	1X6	2.54mm

### 8. Recommended Installation

TTL-WiFi module can be inserted directly into the PCB board. To get the good RF performance, please note the design and location for the antenna. It is suggested to place the module along with PCB with the blank. Please refer to the following three schemes. Note that, if scheme 2 is used, please guarantee that there is no metal under the antenna.

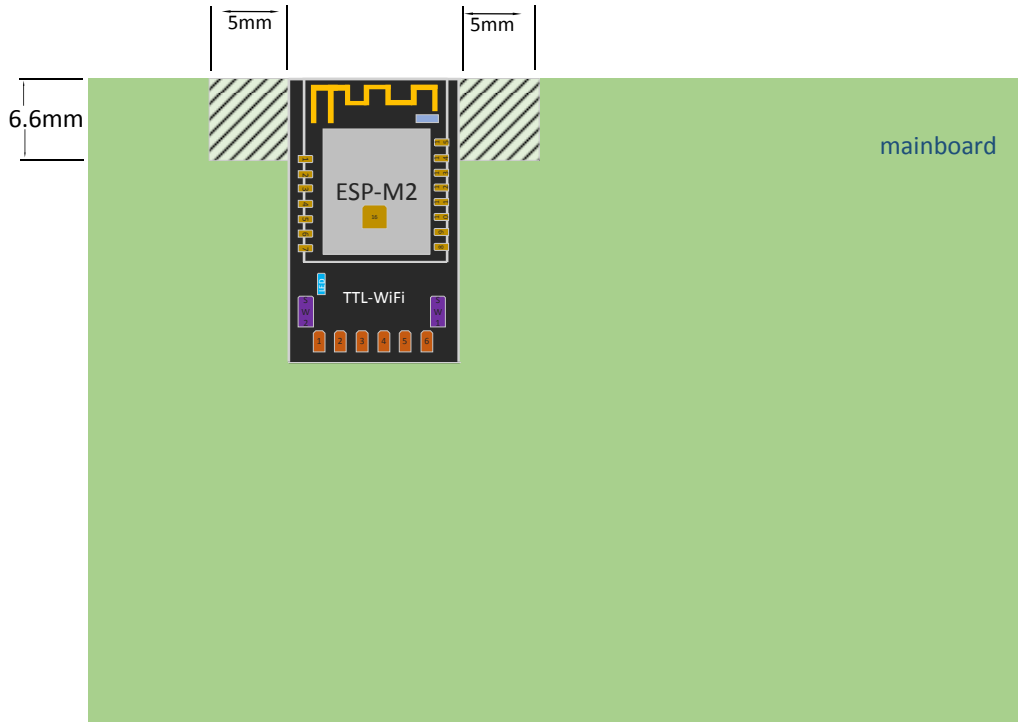

Figure 8.1 Scheme 1



Fig. 8.2 Scheme2

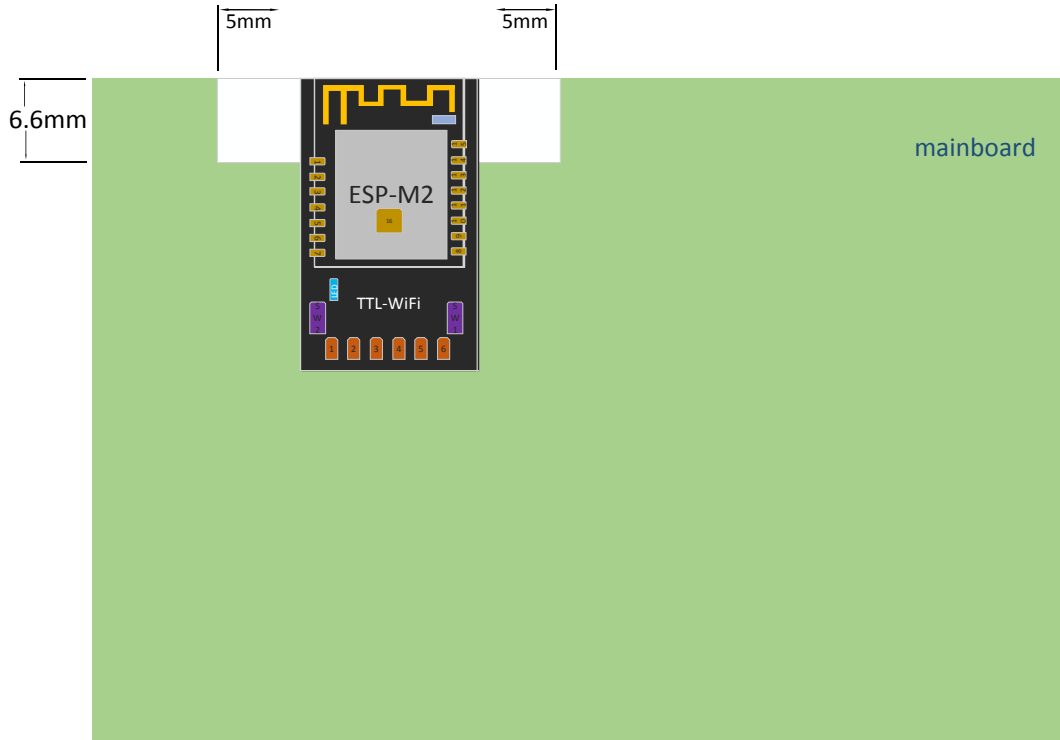

Fig. 8.3 Scheme 3

Doctors of Intelligence & Technology Co., LTD  
No Duplication

## Appendix.1 Parameters of TTL-WiFi Module

Type	Item	Parameters
Wi-Fi	Frequency	2.4G~2.5G(2400M~2483.5M)
	Transmit power	802.11b: +20 dBm
		802.11g: +17 dBm
		802.11n: +14 dBm
	Receiving sensity	802.11b: -91 dbm (11Mbps)
		802.11g: -75 dbm (54Mbps)
802.11n: -72 dbm (MCS7)		
Antenna	PCB onboard antenna	
Hardware	CPU	Tensilica L106 32 bit MCU
	Perpheral	UART/EN/STATE
	Working voltage	4.5-6.0V
	Working current	平均电流: 80 mA
	Working temperature	-40°C ~125°C
	Environment temperature	-40°C ~ 125°C
	size	34mm×17mm×4mm
Soft <sup>note1</sup> (built in the V3.0 firmware)	Wi-Fi mode	Station/SoftAP/SoftAP+Station
	Security mechanics	WPA/WPA2
	encryption	WEP/TKIP/AES
	update	UART Download/OTA
	AT command	Support AT command to check the status
	protocol	TCP/UDP; UDP
	configuration	Built in HttpServer, Web page configuration

## Appendix. 2

From DOIT	
Official site	<a href="http://www.doit.am">www.doit.am</a>
Chinese book	<a href="#">ESPduino 智慧物联开发宝典</a>



<b>Online shop</b>	<a href="http://www.smartarduino.com">www.smartarduino.com</a>
<b>Forum</b>	<a href="https://github.com/SmartArduino/SZDOITWiKi/wiki">https://github.com/SmartArduino/SZDOITWiKi/wiki</a>
<b>IoT Application</b>	<a href="#">智能建筑云</a>
	<a href="#">光伏监控云</a>
	<a href="#">Doit 玩家云</a>
	<a href="#">免费TCP 公网调试服务</a>
<b>Contact Us</b>	
<b>Emails</b>	<a href="mailto:yichone@doit.am">yichone@doit.am</a>
	<a href="mailto:yichoneyi@163.com">yichoneyi@163.com</a>
<b>Skype</b>	yichone
<b>WhatsAPP</b>	008618676662425
<b>WeChat</b>	itchenve
<b>QQ</b>	123433772

<b>From Espressif ESP8266</b>	
<b>Chip</b>	<a href="#">ESP8266 Quick Start Guide</a>
<b>Software</b>	<a href="#">ESP8266 SDK Start Guide</a>
	<a href="#">ESP8266 SDK</a>
<b>Download Tools</b>	<a href="#">ESP8266 Download Tool</a>
<b>Others</b>	<a href="#">ESP8266 Forum</a>
	<a href="#">ESP8266 Resources</a>

## Disclaimer and Copyright Notice

The information in this article, including the URL for reference, if there is any change, without prior notice.

Documents are provided by the current version without any guarantee responsibility, including merchantability, suitable for any particular purpose or non-infringement guarantees, and any guarantees presented by any proposal, specification, or sample mentioned elsewhere. This document has no any responsibility, including the use of the information within this document produced by the infringement of any patent rights. This document in this, by estoppel or otherwise, grant any intellectual property licensing, whether express or implied license.

The Wi-Fi alliance marks shall be owned by the Wi-Fi alliance.

All the mentioned brand names, trademarks and registered trademarks presented in this document are the property of their respective owners, and hereby declare.

### Notice

Because of the product update or other reasons, this manual may change. Doctors of Intelligence & Technology Co., LTD Keeps the right to change the contents of this manual in the absence of any notice or reminders. This manual is used only as a guide, Doctors of Intelligence & Technology Co., LTD would try their best to provide the accurate information in this manual, but it does not ensure that the manual content is completely right and national, all the statements in this manual, and information and advice do not mean to provide any express or implied guarantees.



Doctors of Intelligence & Technology Co., Ltd  
No Duplication